

ELECTRON DEVICES ELECTRONIC SYSTEMS

WATKINS  JOHNSON COMPANY

PALO ALTO, CALIFORNIA

INCORPORATING

STEWART
ENGINEERING COMPANY

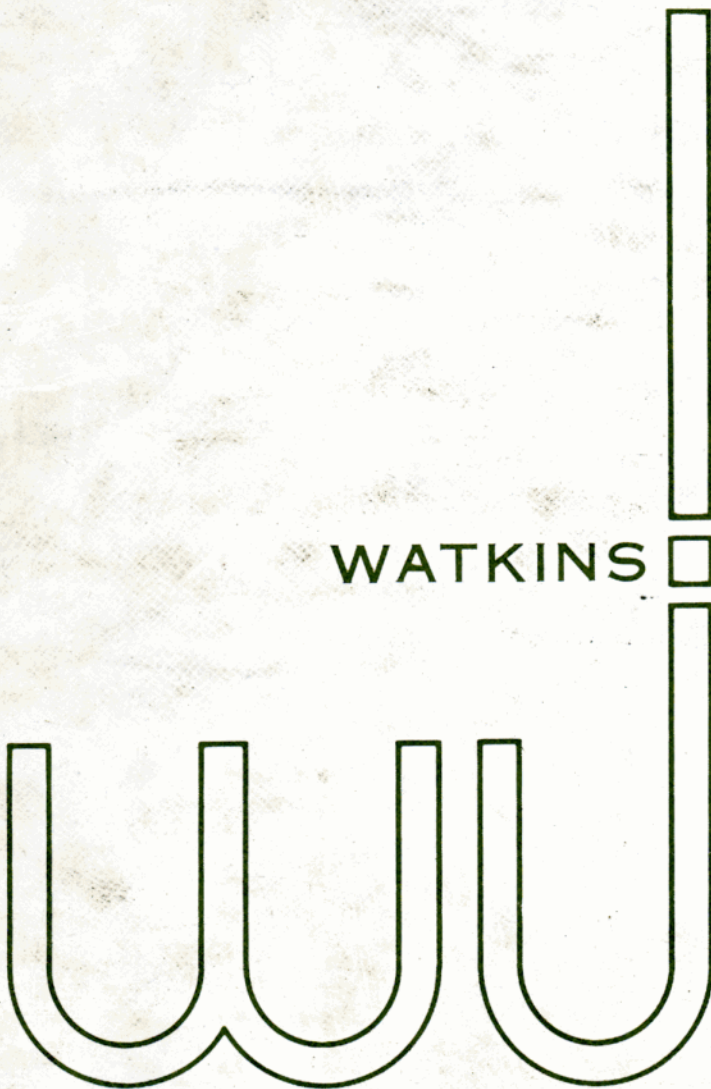

WATKINS-JOHNSON COMPANY

AND ITS SUBSIDIARY

STEWART ENGINEERING COMPANY

Field Engineers

General Sales Information

Company Brochure

Technical Papers Available Upon Request

SECTION ONE

WATKINS-JOHNSON COMPANY AND ITS SUBSIDIARY
STEWART ENGINEERING COMPANY

Field Engineers
General Sales Information
Company Brochure
Technical Papers Available Upon Request

SECTION TWO

WATKINS-JOHNSON COMPANY ELECTRON DEVICES

Table of Contents
Quick Reference Catalog
Ultra Low-Noise Tubes
Noise Generators
Missile and Space Tubes
High Power Tubes
Electronically Tunable Filters

SECTION THREE

STEWART ENGINEERING COMPANY

Table of Contents
Backward-Wave Oscillators, Permanent-Magnet Focused
Backward-Wave Oscillators, Solenoid Focused

November, 1963

WATKINS-JOHNSON COMPANY
STEWART ENGINEERING COMPANY
FIELD ENGINEERS

Eastern Instrumentation, Inc.

(Greater New York City, New Jersey, Eastern
Pennsylvania, Delaware, Maryland,
Washington, D. C., Virginia)

613 Cheltenham Avenue
Philadelphia 26, Pennsylvania
Telephone: Waverly 7-6269

350 Northern Blvd.
Great Neck, L. I., New York
Telephone: 466-9505

808 Ingleside Avenue
Baltimore 28, Maryland
Telephone: Ridgeway 4-3675

Kemco Inc.

(Kansas, Missouri, Arkansas, Texas,
Louisiana, Oklahoma)

P. O. Box 998
Irving, Texas
Telephone: Blackburn 3-6703

12019 Hillcroft
Houston, Texas
Telephone: MO 7-1409

6427 East Kellogg
Wichita, Kansas
Telephone: MU 4-8224

Lancer Associates

(Maine, New Hampshire, Rhode Island,
Connecticut, Massachusetts, Vermont)

428 Marrett Road
Lexington 73, Massachusetts
Telephone: Volunteer 2-7782

M. J. McDonald Company

(Florida, North Carolina, Tennessee,
Alabama, South Carolina, Mississippi,
Georgia)

Route 1
Pfafftown, North Carolina
Telephone: 924-2182

M. J. McDonald Company (continued)

2610 Seabreeze Ct.
Orlando, Florida
Telephone: 422-0039

Ted H. Orndoff

(ASD - Wright-Patterson Air Force Base)

Suite 1113 Talbott Tower
Dayton 2, Ohio
Telephone: Baldwin 2-8284

Ossmann Instruments, Inc.

(New York State except New York City)

101 Pickard Drive
Syracuse 11, New York
Telephone: Glenview 4-2461

3100 Monroe Avenue
Rochester 18, New York
Telephone: Ludlow 6-0380

Vestal Parkway East
P. O. Box 245
Vestal, New York
Telephone: Stillwell 5-9947

Maurice I. Parisier & Co.

(Exporter)

741 - 745 Washington Street
New York 14, New York
Telephone: AL 5-8900

Relations Techniques Inter-
continentales
134, Avenue De Malakoff
Paris XVI^e, France
Telephone: PASSy 43-09

Perlmuth Electronics

(California, Nevada, Arizona,
New Mexico, Colorado, Utah, Idaho)

5057 West Washington Blvd.
Los Angeles 16, California
Telephone: Webster 1-1041

Perlmuth Electronics (continued)

1285 Terra Bella
Mountain View, California
Telephone: 961-2070

8068 Engineers Road
San Diego, California
Telephone: Browning 8-6230

2859 East Thomas Road, Suite B
Phoenix, Arizona
Telephone: Amherst 4-4934

2745 San Mateo, N.E.
Albuquerque, New Mexico
Telephone: Amherst 8-6797

S. Sterling Company

(Michigan, Ohio, West Virginia,
Western Pennsylvania)

21250 10-1/2 Mile Road
Southfield, Michigan
Telephone: 442-5656

5827 Mayfield Road
Cleveland 24, Ohio
Telephone: HI 2-8080

3300 S. Dixie Drive
Dayton 39, Ohio
Telephone: AX 8-7573

4232 Brownsville Road
Pittsburgh 27, Pennsylvania
Telephone: TU 4-5515

Scientific Sales Company

(Indiana, Illinois, Wisconsin,
Minnesota, Eastern Iowa)

8272 N. Merrill Street
Chicago 48, Illinois
Telephone: 825-1478

GENERAL SALES INFORMATION

ORDERING

All orders should be addressed to Watkins-Johnson Company, 3333 Hillview Avenue, Palo Alto, California, or to our representative in your area. Inquiries about our products may be addressed in the same manner.

SHIPPING

All shipments are made FOB our plant, Palo Alto, California. If method of shipment is not specified by purchaser, items will be shipped in the most advantageous manner.

DELIVERY

Delivery schedules will vary depending upon product and quantity ordered. Watkins-Johnson will attempt to meet the delivery schedule buyer requests. We recommend you contact our representative or Watkins-Johnson Company at the time of order placement for firm delivery information.

RETURNS

Merchandise may be returned for adjustment only with prior written approval from Watkins-Johnson. Before any action can be taken on returned merchandise, complete service reports covering the items returned must be received. We recommend that these reports be packed with the items returned.

PRICES

All prices are subject to change without notice. Quantity prices are offered under certain conditions on some standard items. Additional information may be obtained from your Watkins-Johnson Company representative or the plant.

TERMS

Terms of payment are net 30 days.

WARRANTIES

All Watkins-Johnson products are thoroughly tested and inspected prior to shipment and are warranted to perform satisfactorily. Warranty periods vary with the product. Should any product prove unsatisfactory, please refer to RETURNS above.

APPLICATIONS ENGINEERING

Watkins-Johnson staff of Applications Engineers is available as a service to you, the customer. They are well versed on the applications of Watkins-Johnson products and would be happy to serve you.

November, 1963
Watkins-Johnson Company

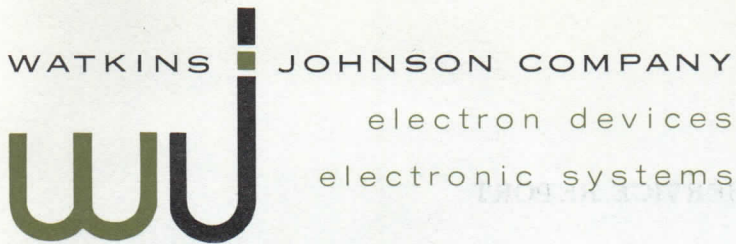

ELECTRON DEVICE WARRANTY

ATTENTION: PURCHASING DEPARTMENT
OPERATING PERSONNEL

THE COMPLETED SERVICE REPORT ON THE REVERSE SIDE MUST ACCOMPANY
ANY ELECTRON DEVICE RETURNED FOR ADJUSTMENT

THE FOLLOWING ARE CONDITIONS OF SALE AND MUST BE COMPLIED WITH FOR
RECOGNITION OF ANY CLAIM UNDER THE WARRANTY

1. WITHIN 15 DAYS of receipt, these electron devices must be examined since, in case of shipping damage, the customer has a claim against the carrier--not against Watkins-Johnson Company.
 - A. Examine the devices for any physical damage.
 - B. Determine whether or not the devices meet specifications. Damage to devices is often internal and can only be determined electrically, such as noting an open filament or loss of cathode emission.
2. Failures, other than those due to shipping damage, which occur within one year from the date of original shipment from Watkins-Johnson Company's plant, and for which Watkins-Johnson accepts responsibility, will be treated as follows:
 - A. Purchaser should report the failure to the Watkins-Johnson Company and receive authorization from W-J to return the device.
 - B. Purchaser should complete the "DEVICE SERVICE REPORT", pack it with the device and return both the device and the SERVICE REPORT to:

Watkins-Johnson Company
3333 Hillview Avenue
Palo Alto, California
Attention: Quality Assurance
 - C. If a device, as qualified above, failed during the Full Warranty Period, it will be replaced by Watkins-Johnson without charge to purchaser
 - D. If a device, as qualified above, failed during the Prorated Warranty Period, the purchaser may receive credit on the purchase of a replacement device at the effective catalog price in accordance with the following formula:

$$\text{Credit} = \left(\frac{\text{Replacement Device Price}}{\text{Device Price}} \right) \text{ minus } \left(\frac{\text{Replacement Device Price}}{\text{Device Price}} \right) \times \frac{\text{Hours of heater operation in excess of Full Warranty Period, if any}}{\text{Total Hours of Prorated Warranty Period}}$$

3. No credit will be allowed on any failure of a device which either occurs more than one year after date of shipment or after more than the warranted hours of heater operation.
4. This warranty is expressly in lieu of all other obligations of Watkins-Johnson Company and seller makes no other warranty, express or implied.
5. PLEASE DO NOT RETURN DEVICES to Watkins-Johnson Company without first obtaining authorization. All return and reshipping charges will be paid by the party judged to be at fault.

NOTE: Hours of Warranty for individual device types may be obtained by requesting Watkins-Johnson Warranty Schedule from either our local representative or Watkins-Johnson Company.

5 April 1963

DEVICE SERVICE REPORT

Watkins-Johnson type _____

Date _____ 19 _____

Serial no. _____

IMPORTANT: THIS SERVICE REPORT MUST ACCOMPANY ALL TUBES RETURNED FOR ADJUSTMENT. ANSWER ALL QUESTIONS FULLY, SINCE NO CLAIMS CAN BE CONSIDERED UNLESS ADEQUATE INFORMATION IS GIVEN. SEE OTHER SIDE OF THIS FORM FOR FURTHER INSTRUCTIONS:

Date received _____

Date first tested _____

Date placed in service _____

Date of failure _____

Total no. of hour of heater operation _____

Give operating conditions existing at the time of failure of tube to perform according to specifications.

Collector voltage _____	Anode No. 3 voltage _____
Collector current _____	Anode No. 4 voltage _____
Helix voltage _____	Heater voltage _____
Helix current _____	Heater current _____
Anode No. 1 voltage _____	Solenoid voltage _____
Anode No. 2 voltage _____	Solenoid current _____

Outline briefly any unusual occurrence before tube failure: _____

Reason for returning tube: _____

Report prepared by: _____

Customer's name _____

Address _____

City _____ Zone _____ State _____

SEE OTHER SIDE

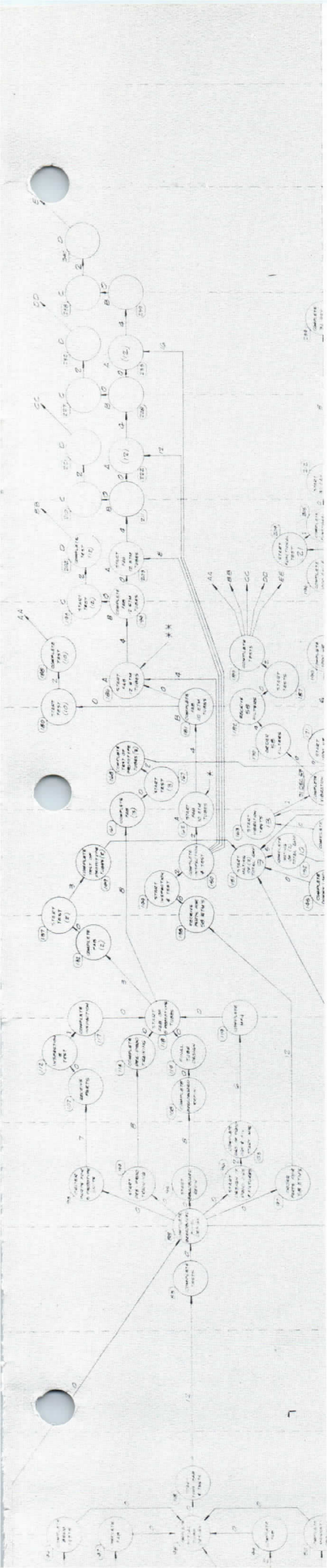

WATKINS ■ JOHNSON COMPANY

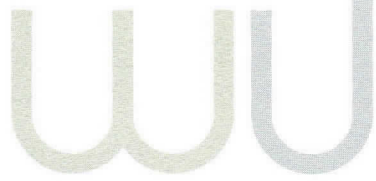

ELECTRON DEVICES
 DIVISION

ELECTRONIC SYSTEMS
 DIVISION

STEWART
 ENGINEERING COMPANY

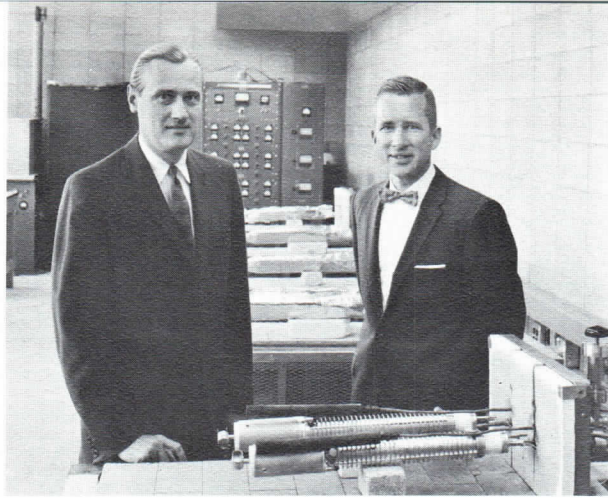

DR. WATKINS and DR. JOHNSON



DR. ROLF W. PETER, Manager, Electron Devices Division
BRUCE G. BLEECKER, Manager, Manufacturing Department, Electron Devices Division
DR. O. THOMAS PURL, Manager, Tube Research and Development Department, Electron Devices Division
WAYNE H. ROBINSON, Manager, Applications Engineering



JOSEPH G. RUBENSON, Manager, Systems Division
ROBERT H. RECTOR, Member of the Technical Staff, Systems Division
EDDY HOSE, Member of the Technical Staff, Systems Division
RICHARD E. POSPISIL, Member of the Technical Staff, Systems Division
CARL D. HEROLD, JR., Member of the Technical Staff, Systems Division

Entrance, Watkins-Johnson Company, Stanford Industrial Park, Palo Alto



BOARD OF DIRECTORS

- DWIGHT M. COCHRAN, President, Kern County Land Company**
A. CRAWFORD GREENE, Director, Kern County Land Company
WILLIAM R. HEWLETT, Executive Vice President
 Hewlett-Packard Company
DR. H. RICHARD JOHNSON
GEORGE G. MONTGOMERY, Chairman of the Board
 Kern County Land Company
RAYMOND F. STEWART, Consultant to the Company
DR. FREDERICK E. TERMAN, Vice President and Provost
 Stanford University
DR. DEAN A. WATKINS

OFFICERS

- DR. DEAN A. WATKINS, President and Treasurer**
DR. H. RICHARD JOHNSON, Executive Vice President
DR. ROLF W. PETER, Vice President
MRS. C. LOUISE BEER, Secretary



BRUNO KAISER, Manager, Applications Engineering, Stewart Engineering Company
CLYDE E. COLEMAN, Tube Manufacturing Manager, Stewart Engineering Company
RAYMOND F. STEWART, Consultant and Founder, Stewart Engineering Company
GERALD C. RICH, Vice President and General Manager, Stewart Engineering Company
DR. JAMES W. SEDIN, Engineering Manager, Stewart Engineering Company

Entrance, Stewart Engineering Company, Santa Cruz

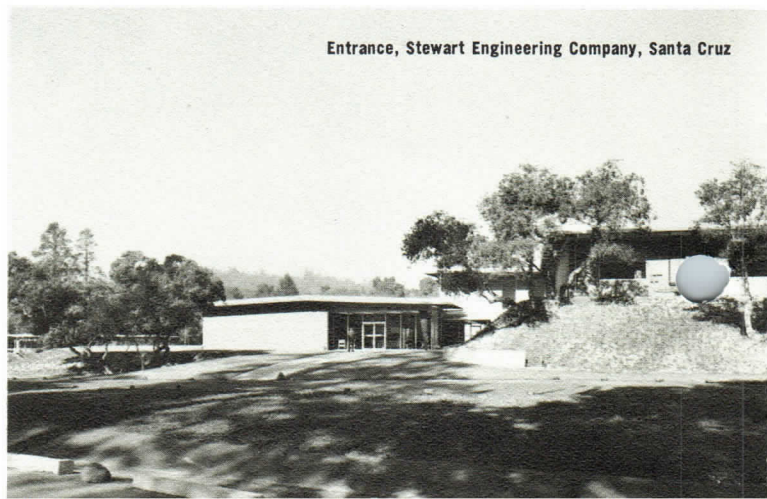



WATKINS-JOHNSON COMPANY was formed in December 1957 to engage in research, development and production of advanced electron devices and related electronic systems and equipments. It now employs 450 people at a 23-acre site in Stanford Industrial Park, adjacent to Stanford University, and at a 30-acre site near Santa Cruz, California. A major financial interest is owned by the Kern County Land Company, a land and development organization incorporated in 1892 and well known in the West.

Watkins-Johnson is deeply involved in advancing the state of the art in the fields of microwave electron-beam and solid-state devices, as well as optical-frequency devices. Programs range from low-noise to high-power and cover frequencies from 250 Mc through visible light. Production of low-noise traveling-wave tubes, YIG filters, and medium-power traveling-wave tubes is now under way.

Starting in September 1960 with the organization of a Systems Division, the widening base of technical activity has produced numerous sophisticated devices that have been employed at W-J as key elements in a variety of advanced equipments. Principal activities are in the fields of space communications, reconnaissance, surveillance, and countermeasures. Transmitters, power amplifiers, electronically-tunable receivers, low-noise amplifiers, phase-stabilized receivers and transmitters, and ancillary equipment have been developed and delivered. Related study and research programs are undertaken when needed.

With the acquisition of Stewart Engineering Company in June 1963, Watkins-Johnson now offers a broad line of backward-wave oscillator tubes for military and industrial applications. Many tube types are produced in large quantity and are accepted as standards of performance and quality.

Watkins-Johnson takes pride in the caliber and accomplishments of its technical staff, which includes 13 Ph.D.'s and has more than 65 patents and 161 published journal articles to its credit. By policy, the staff concentrates its talents on those problems which are at the forefront of the technology, with complete follow-through from research and development, through production refinement and production.

ELECTRONIC SYSTEMS

The unusual requirements of modern sophisticated electronic systems demand the combined talents of imaginative broad-gage systems engineers and practical creative components engineers. Watkins-Johnson offers a unique capability in both these areas, with accomplishments in solving complex system problems effectively and economically. By selecting Watkins-Johnson, where systems and components engineers work side-by-side, the customer gains the benefits of a full interchange of ideas and information on a continuing basis throughout a development: the full potentialities of components are exploited; pitfalls of costly over-specification of components or over-design of the system are avoided; complete freedom from interface problems is assured.



SATELLITE TELEMETRY AMPLIFIER PACKAGE Output is 12 watts cw at 2.0 to 2.4 Gc. This unit has been fully qualified for one year operation in orbit.

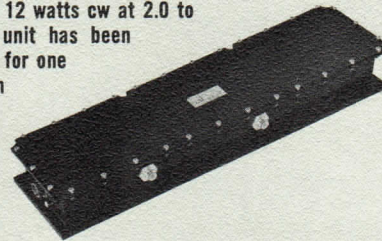

MILCOMSAT AMPLIFIER PACKAGE Output is 2.5 watts cw minimum at X-band, plus 1 watt of regulated DC. Input is 13.5 watts DC maximum. Diagnostic telemetry and control circuits are included.

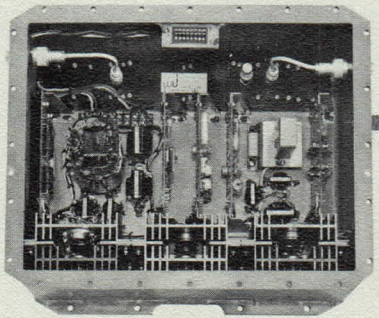

AIRBORNE FM TELEMETRY TRANSMITTER Output is 20 watts cw at 4 Gc with 300 mc modulation bandwidth. Following a crash development program, all units of this series performed without failure during field tests of the weapon system in which they were used.

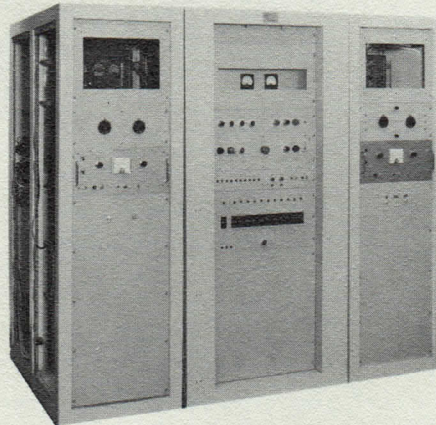

GROUND-BASED TRANSMITTING AMPLIFIER Output is 30 kw peak at C-band on two channels. Input is PPM coherent pulse train with 80 megabit bi-phase modulated signal on each pulse. Input spectrum is preserved by means of ultra-stable design.

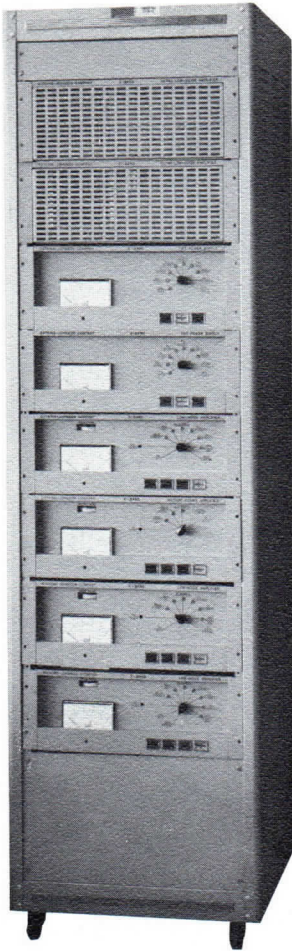

PHASE-STABILIZED RADAR RECEIVER Two high-gain low-noise matched channels are provided for a monopulse angle-measuring system. Extreme phase linearity assures distortion-free amplification of wideband signals.

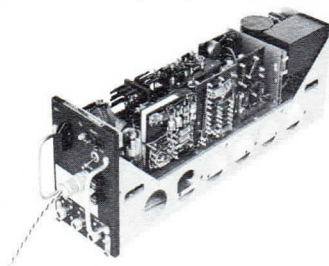

AIRBORNE DINA JAMMER Output is 10 watts integrated noise over the 2-4 Gc range.

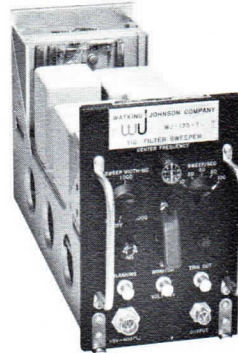
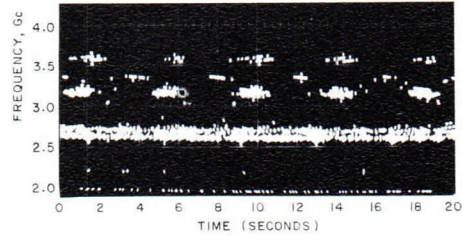
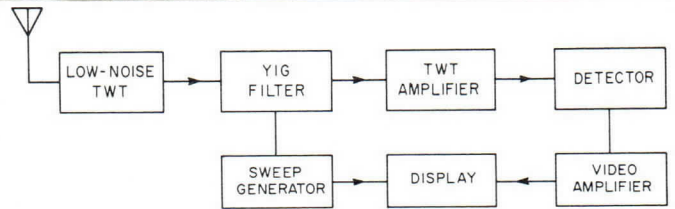

SWEPT TRF RECEIVER Block diagram of a 2-4 Gc receiver using a YIG filter to provide 20 mc instantaneous bandwidth. Falling raster display above is an off-the-air record over a 20-second period, with 20 sweeps per second. Control and drive unit is shown at left.

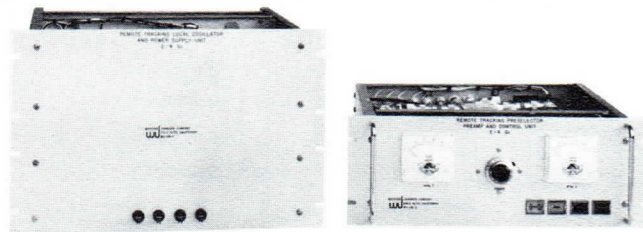

REMOTELY TUNABLE RECEIVER Includes YIG preselector and tracking local oscillator linearized by feedback from a YIG-tuned discriminator. Tuning range is 2-4 Gc with single control knob.

UNDER DEVELOPMENT

SOLID-STATE S-BAND SUPERHET RECEIVER Includes YIG preselector and tracking YIG-tuned tunnel diode local oscillator with solid-state mixer, IF amplifier, and detector.

CRYSTAL-CONTROLLED TUNABLE 3-CHANNEL MONOPULSE RECEIVER Automatic phase and amplitude balancing is provided. Tuning range is 2-4 Gc based on frequency synthesizer for high stability and precision.

RFI RECEIVING SYSTEM Covers 1-12 Gc in one band with low-noise input and digitized output. Built-in calibration system provides accurate readout.

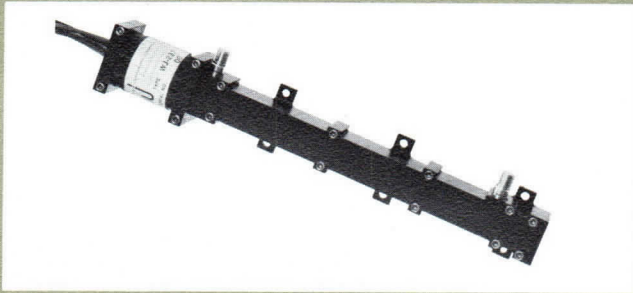

WJ-237 High-efficiency, ultra-reliable traveling-wave tube for space communication and telemetry



WJ-228 C-band 15-kw power traveling-wave tube, now in large-scale production



WJ-268 Ultra-low-noise traveling-wave amplifier with integral power supply for L-band—representative of a complete line of low-noise amplifiers

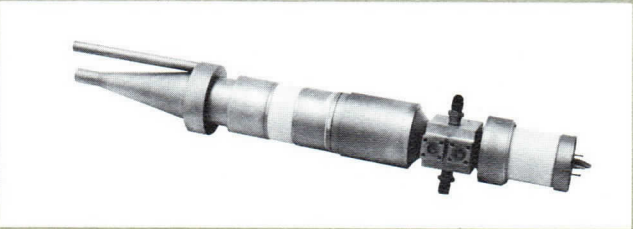

WJ-226 1000-watt cw power traveling-tube for 35 Gc



WJ-270 DC-pumped high-precision cw gas laser; an integral power supply is provided



WJ-506 Nonreciprocal, two-stage, electronically tuned bandpass filter for X-band



WJ-520 Tunnel-diode oscillator, electronically tunable over the S-band octave



WJ-136 Multi-channel, double-tuned YIG filter; individual electronic tuning of the 20 channels permits varying its bandpass characteristic



ELECTRON DEVICES

This Division is engaged in research, development, and production of electron tubes and solid-state devices of advanced design. A line of long-life, ultra-low-noise traveling-wave tubes from 200 to 12,000 Mc (with lowest noise figures of 2 to 5 db) is in production, and up to 100 Gc in development. Miniaturized versions of these tubes are also available in rugged packages, including permanent-magnet focusing and integral power supply — all meeting MIL-E-5400 specifications.

A line of ultra-high-reliability space-communication tubes from 1 to 11 Gc has been developed. These lightweight, high efficiency traveling-wave tubes are built to withstand the extreme environments experienced during launch and in space. For phased-array systems, a C-band power tube is now in large-scale production, and an L-band 100 kw tube is in development. Two millimeter-wave power tubes in development have produced the highest powers on record at 35 Gc and at 100 Gc.

A family of electronically-tunable YIG filters, limiters and tunnel-diode oscillators is in development and production. A solid-state octave-tunable parametric amplifier is nearing completion. Research programs on semiconductor and gas lasers, light modulators and detector devices are in progress. Product engineering of a line of dc-pumped cw gas lasers with integral power supply is nearly complete. Capabilities and experience of the technical staff include research, development and production in the fields of microwave solid-state devices, involving semiconductor and ferrimagnetic devices and materials, acoustic microwave delay lines and amplifiers, infra-red and optical lasers, display devices, electron dynamics, beam focusing, plasma devices, and ion propulsion. This group has an outstanding record of pioneering contributions; its inventive and engineering capabilities are second to none in the industry.

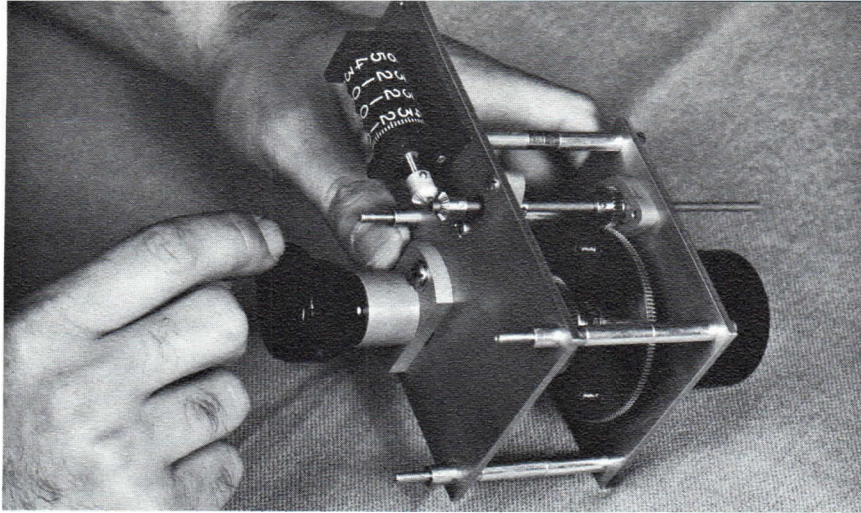

Precision mechanism designed and fabricated at W-J for indicating directly receiver frequency in megacycles

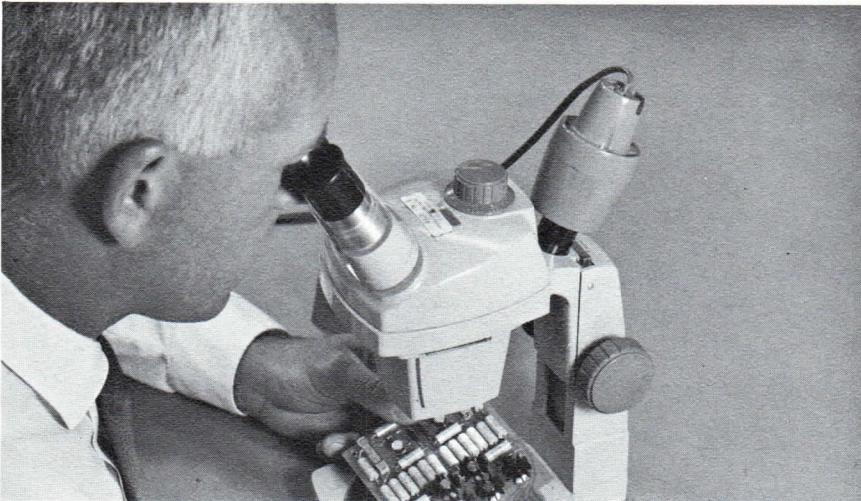

Engineer inspects printed circuit sub-assembly designed at W-J for use in electrically tuned receiver

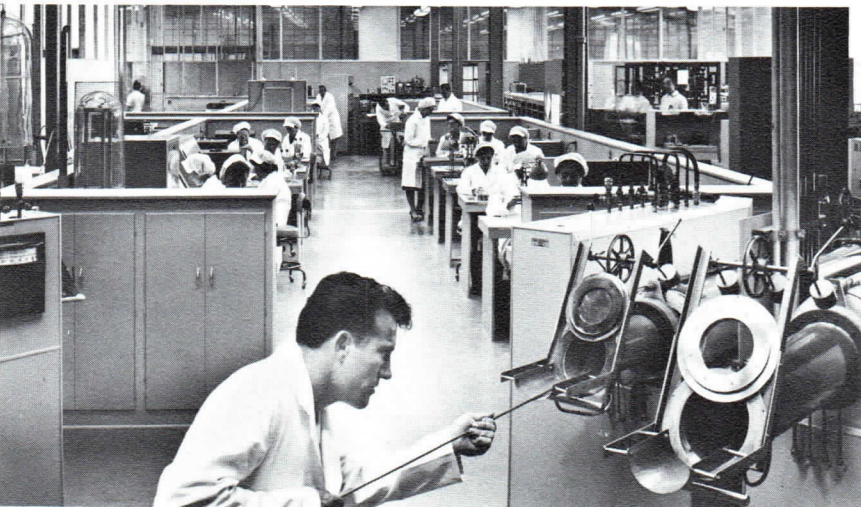

Controlled access area for assembly of low-noise tubes; hydrogen atmosphere furnaces in foreground

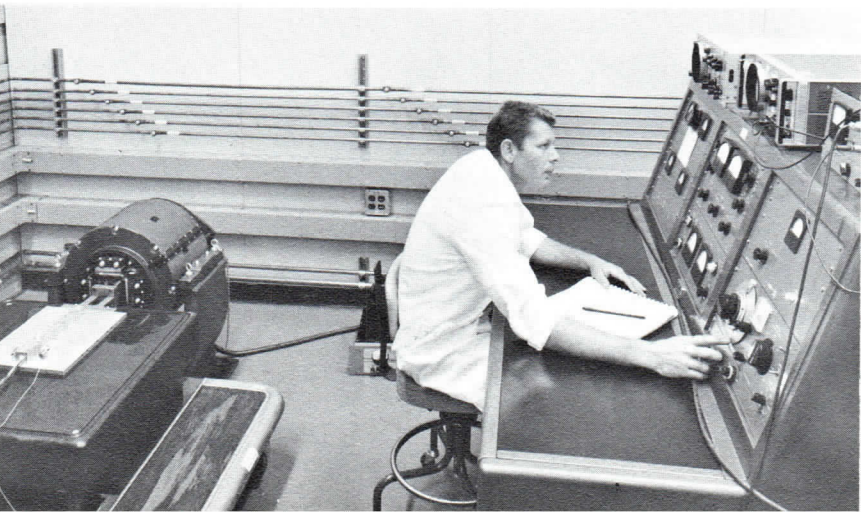

Vibration test instrumentation, with a WJ-227 space-communication traveling-wave tube on test

Critical assembly and inspection of Stewart BWO's take place in this "clean room" with electrostatically filtered atmosphere

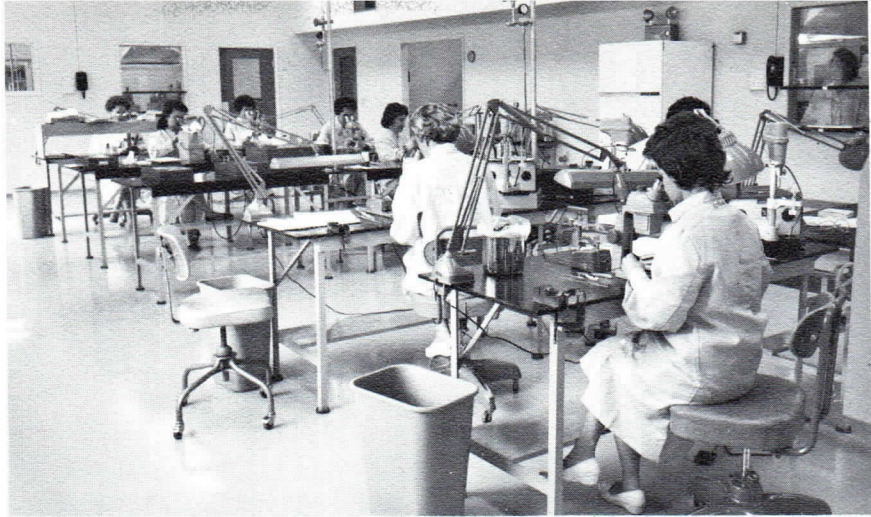

Assembling power-supply components to be integrated in W-J traveling-wave tube low-noise amplifiers



At W-J's Santa Cruz subsidiary, Stewart Engineering Company, BWO's spend from 24 to 150 hours in this exhaust-pump area



Engineer examines encapsulated subassemblies being developed at W-J for military communications satellite transmitter

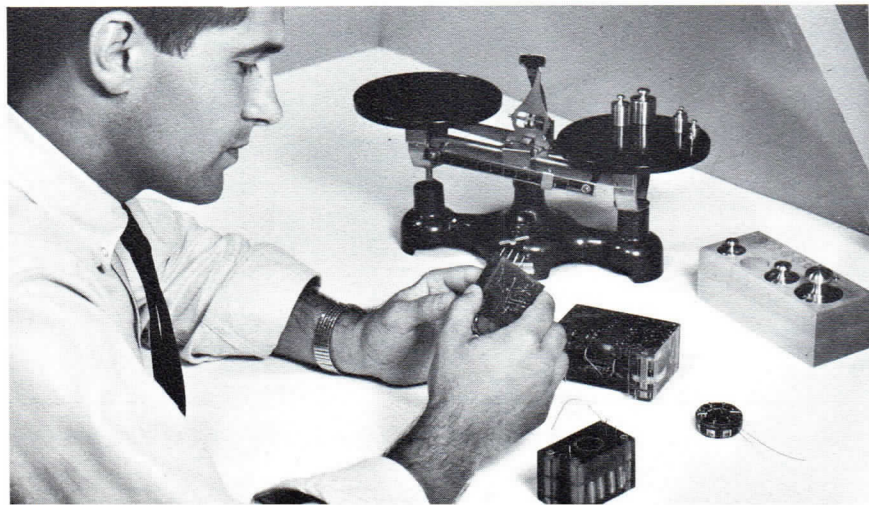

STEWART ENGINEERING COMPANY This wholly-owned subsidiary of Watkins-Johnson Company is located 35 miles south of Palo Alto in the Santa Cruz Mountains. Its 120 employees, in 37,000 square feet of modern building space and well equipped with excellent facilities, design and manufacture the finest backward-wave oscillator tubes in the world.

Initial activities began in 1952 and the company was incorporated in 1956. As a result of rapid growth while maintaining high quality in its product line, and good service to its customers, Stewart presently enjoys the position of being the largest supplier of backward-wave oscillators in the test instrument field.

Stewart achieves its quality as a result of designs which can be manufactured with good control as to uniformity. This, together with the use of unique fabrication and processing techniques — and, more important, talented employees — provides the customer with the best the industry has to offer.

The development of new tube types and the improvement of designs is a continuous activity at Stewart. Based on the needs of equipment and system suppliers, Stewart engineers are always prepared to design new tubes on request or to modify present types to satisfy requirements on a quick-reaction schedule. This activity is not confined to the backward-wave oscillator tubes, but includes allied devices.

While Stewart's major product line consists of microwave tubes, the company is also engaged in the design and manufacture of processing furnaces and precision spot welders. The furnace line includes three sizes of 1200°C controlled-atmosphere furnaces and vacuum furnaces. An 1800°C line of furnaces also has been developed for early production.

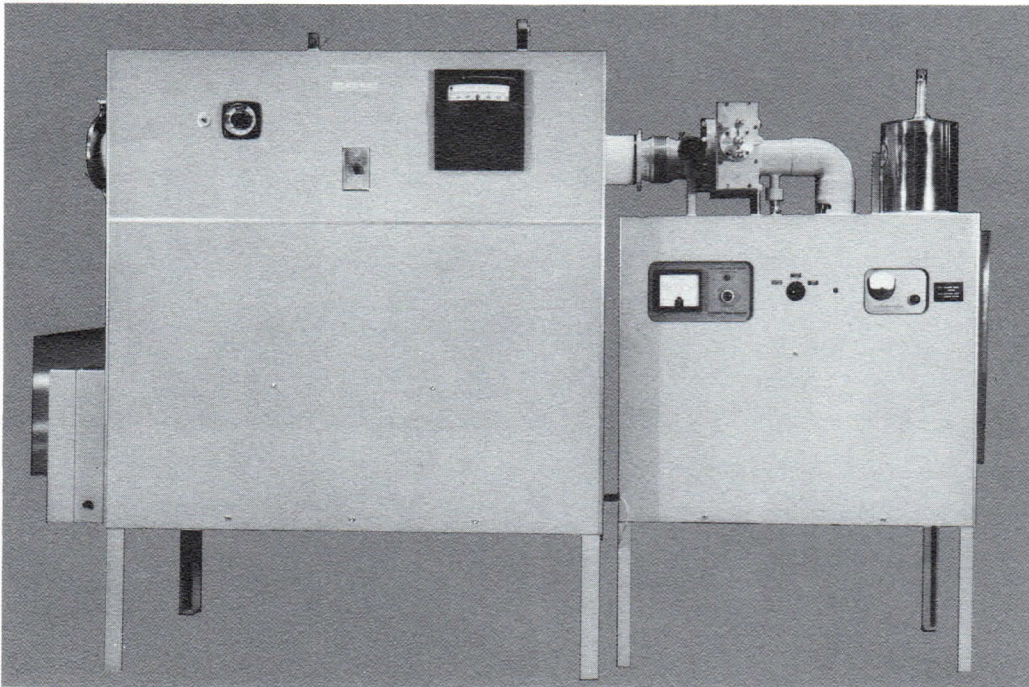

New Stewart Engineering Company vacuum furnace Model 6V-42; with diffusion pumping system, Model 5/6 P-42B.

Type SE-301 ruggedized X-band backward-wave oscillator

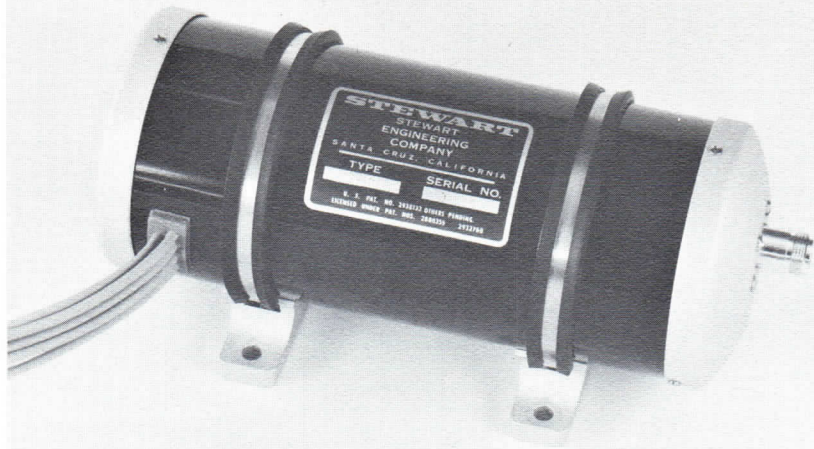

C-band backward-wave oscillator, type SE-203

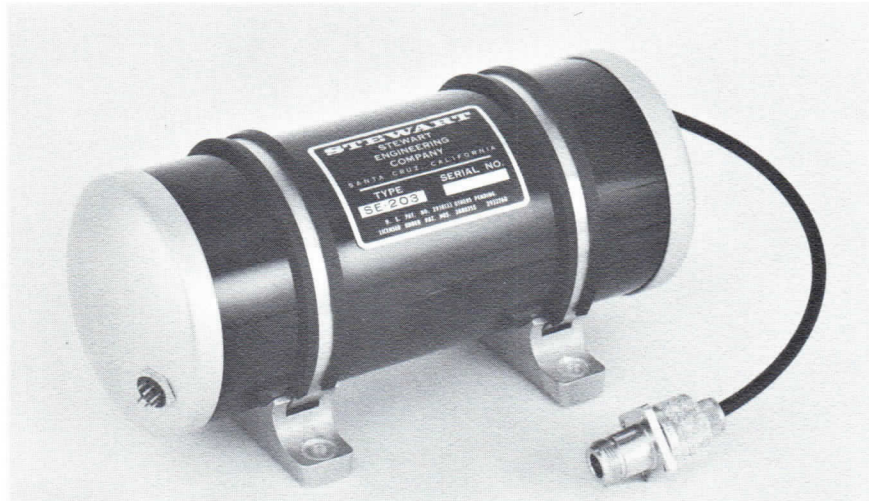

Bifilar-helix C-band backward-wave oscillator with balun, type SE-206

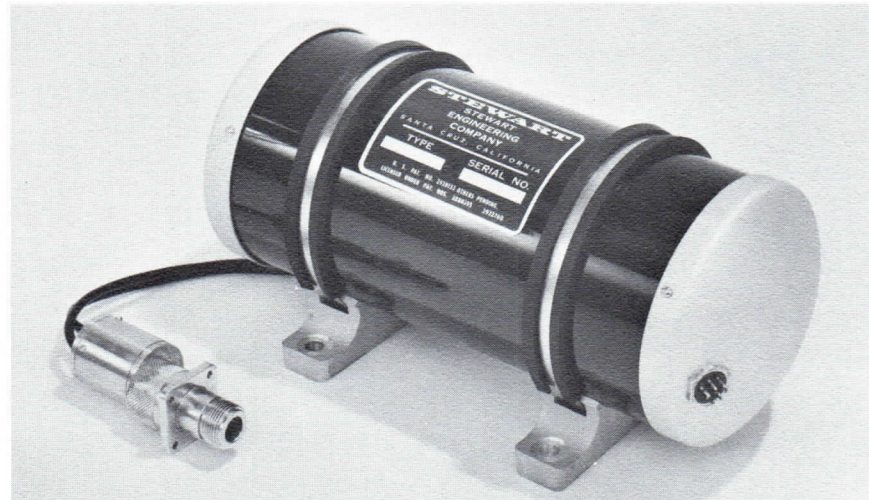

The SE-211, a compact and square-packaged C-band BWO

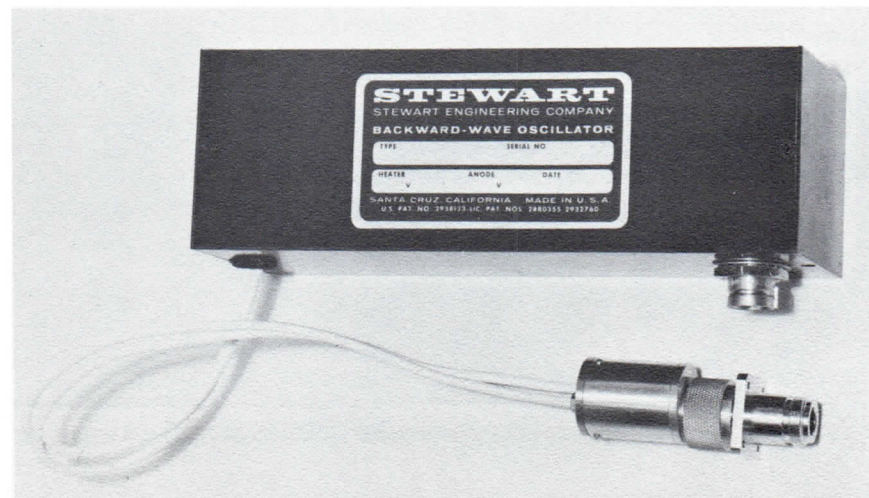

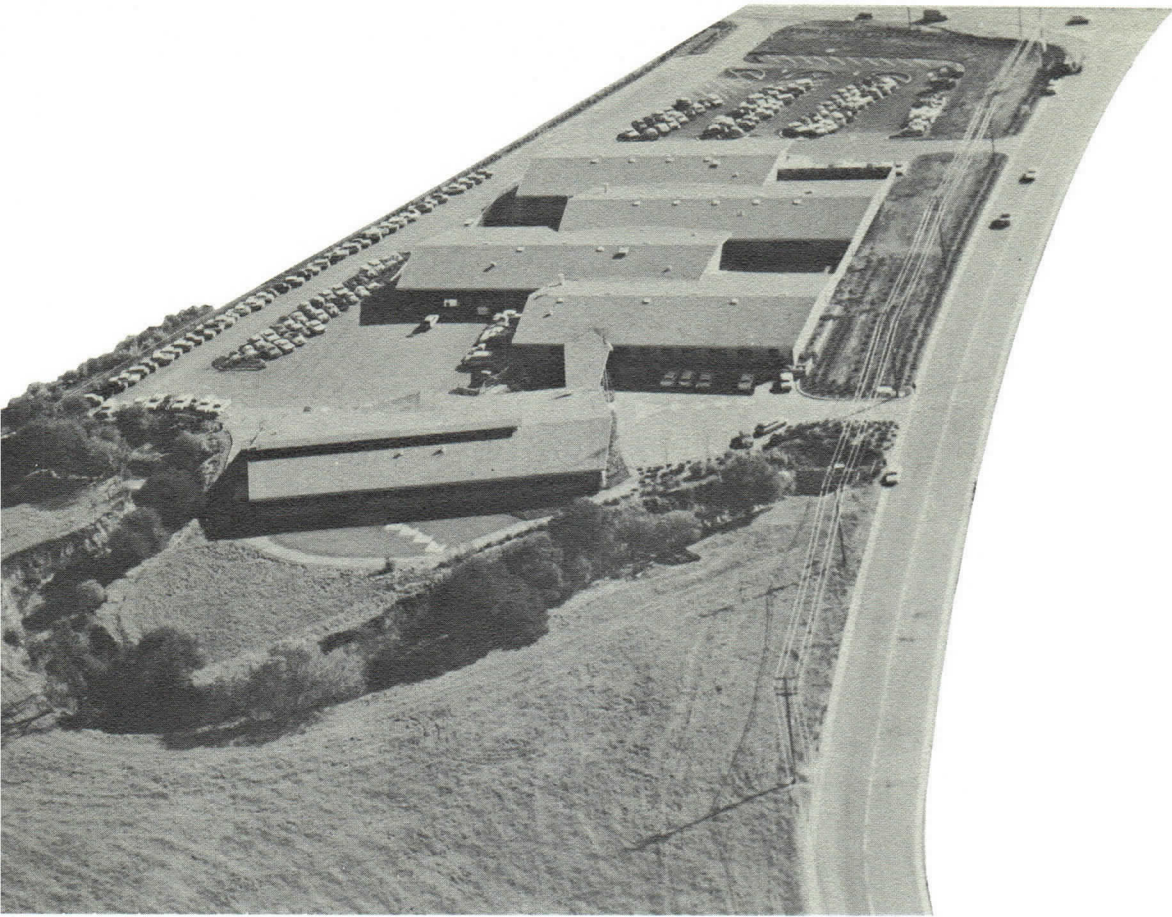

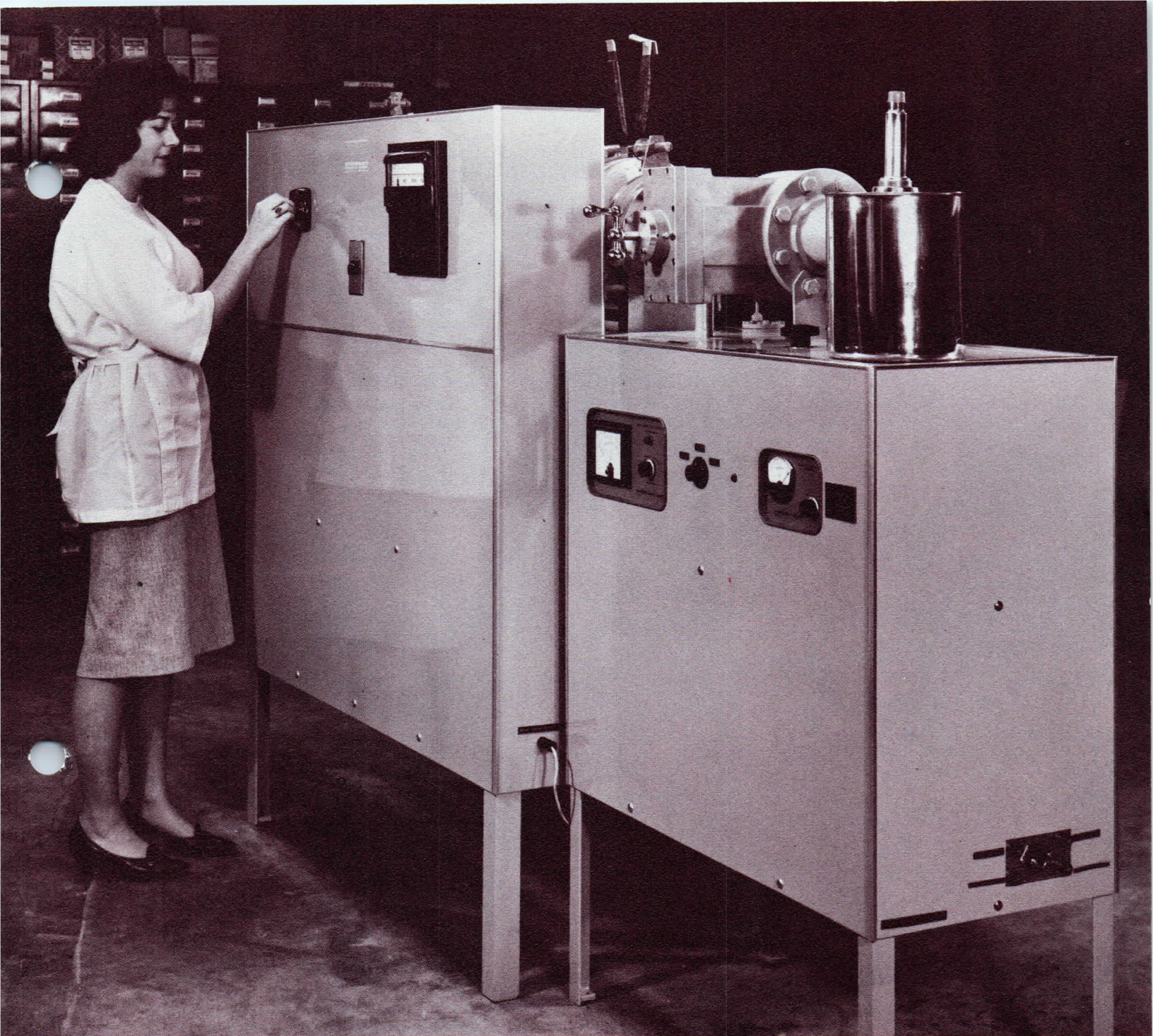

Model 6V-42 with Diffusion Pump System

STEWART **VACUUM FURNACES**

Widely used for:

OUTGASSING
OXIDE-FREE HEAT TREATING
VACUUM BRAZING
SPACE ENVIRONMENT TESTING

Ultra-pure high vacuum
Fast heating and cooling
Convertible to gas atmosphere use
Economical to operate

Ultra-Clean, Rapid Firing

STEWART VACUUM FURNACES

New Stewart Vacuum Furnaces capitalize on the time-tested design of Stewart Controlled Atmosphere Furnaces to produce an exceptionally clean and efficient system for vacuum firing operations. They operate economically, require little maintenance, and return substantial savings in reduced upkeep through the years.

Heart of the system, consisting of a rapid-heating furnace and a high-

capacity vacuum pumping apparatus, is the Stewart Mono-Tube muffle, a simple alloy thermal tube that replaces the conventional wire-wound muffle. Extremely low "heat inertia" of the one-piece, thin-wall tube lets it heat the furnace to 1200°C (2192°F) from room temperature in approximately ten minutes. The tube is connected through water-cooled electrical terminals to the single-turn secondary of the single-

phase transformer. Optional fast-cooling feature speeds temperature decline to room temperature in about ten minutes.

Key to the exceptional cleanliness of vacuum operations is the vacuum chamber, a fused quartz tube within the Mono-Tube muffle. A quick-opening loading door seals the quartz tube on one end, and the vacuum pumping system is sealed to the opposite end.

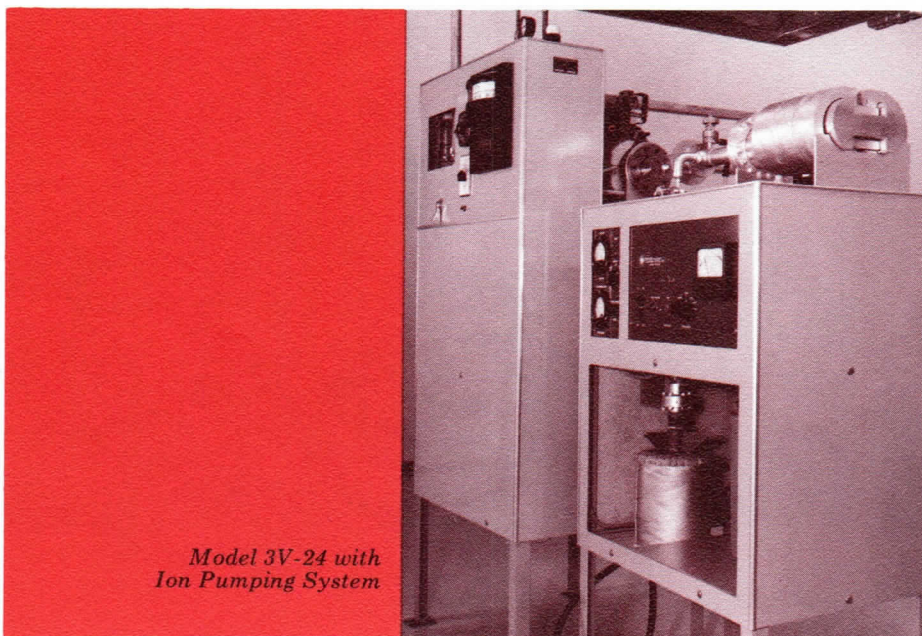

*Model 3V-24 with
Ion Pumping System*

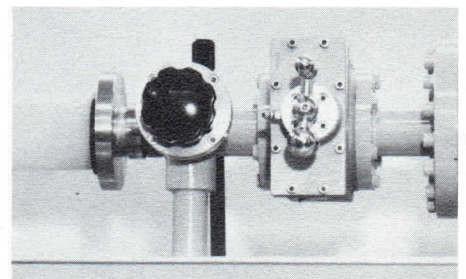

*Vacuum coupling and valves between
chamber and pump system*

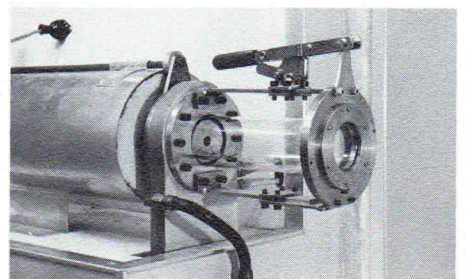

Quick-opening vacuum-sealed door

VACUUM PUMPING SYSTEMS

Either of two alternative vacuum pumping systems is employed with Stewart furnaces. System "A" employs a sorb-type fore pump that absorbs air molecules when cooled with liquid nitrogen, and creates vacuums on the order of 15 microns. An ion pump is started at this level to reduce chamber pressure to 10^{-6} , and ultimately as low as 10^{-9} Torr.

Neither unit uses moving parts or liquids and both are tightly sealed to the atmosphere during operation, thus assuring maintenance of an ultra-high vacuum.

The alternate "B" system employs a more conventional mechanical roughing pump and a diffusion pump. The fore pump, as in the "A"

system, evacuates the chamber to about a 50-micron vacuum, and the diffusion pump is started to attain a vacuum of at least 10^{-5} Torr. Both a liquid-nitrogen-cooled baffle and an optically dense baffle are inserted in-line between the pump system and the vacuum chamber to prevent pump oil vapors and other impurities from entering the firing zone.

Effective July 1, 1963

PRICE SCHEDULE

Vacuum Furnaces

Model	Price	Options		Crating. (If required)
		Fast Cooling Feature	Time Control	
3V-24	\$2,975.00	\$245.00	\$125.00	\$150.00
5V-42	4,975.00	285.00	125.00	190.00
6V-42	5,975.00	295.00	125.00	190.00

Vacuum Pumping Systems

3P-24A (ion)	\$4,975.00	-	-	\$130.00
3P-24B (diff)	4,750.00	-	-	130.00
5/6P-42A (ion)	9,275.00	-	-	150.00
5/6P-42B (diff)	5,875.00	-	-	150.00

Conversion Kits

Model	To Convert	Into	For	Price
3K-24E	3V-24	3E-24	Atmosphere	\$350.00
3K-24D	3V-24	3D-24	Atmosphere	895.00
3K-24V	3D-24 or 3E-24	3V-24	Vacuum	295.00
5K-42E	5V-42	5E-42	Atmosphere	\$410.00
5K-42D	5V-42	5D-42	Atmosphere	1,075.00
5K-42V	5D-42 or 5E-42	5V-42	Vacuum	495.00
6K-42E	6V-42	6E-42	Atmosphere	495.00
6K-42D	6V-42	6D-42	Atmosphere	1,275.00
6K-42V	6D-42 or 6E-42	6V-42	Vacuum	650.00

NOTES:

1. Terms are net 30 days, F.O.B. Santa Cruz, California. All prices are subject to change without notice.
2. Temperature controller supplied is an on-off type with 1% accuracy. Available at an extra cost of \$145.00 is a $\frac{1}{2}$ % proportional-type controller which prevents overshoot and provides more accurate control. Other controllers are available on special order.
3. Crating is required for shipment by rail or motor freight. Skids, required for shipment by moving van, are furnished at no additional charge. (Moving van is recommended for all shipments except for 5-inch and 6-inch furnaces going to the East Coast.)
4. The "D" Model Controlled Atmosphere Furnaces are designed for continuous-flow operation. They have a water-jacketed cooling section and two doors with flame curtains, but not the fast-cooling feature. This feature is available as an option.
5. The "E" Model Controlled Atmosphere Furnaces are intended for batch operation. They have the fast-cooling feature but only one door, no flame curtain and no cooling section.

STEWART
ENGINEERING COMPANY
SANTA CRUZ ■ CALIFORNIA

LOADING PLATFORM

A New Accessory, For Use With All

STEWART CONTROLLED ATMOSPHERE FURNACES

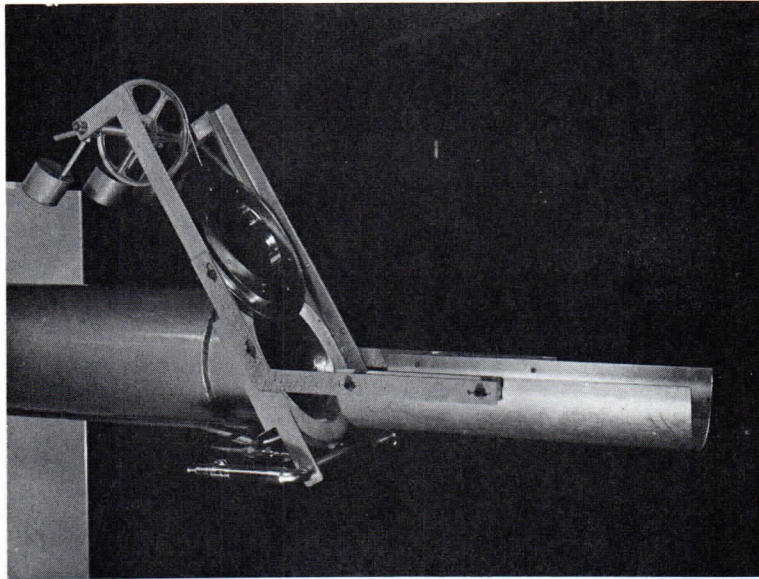

Increased Ease of Operation

Faster Loading When Using Furnace for
Push Through Firing

Saving of Gases Through Faster Loading

Easy Mounting to Existing Furnaces

Available to Install On Existing Models
Or As An Optional Accessory On New Furnaces

PRICE

3 inch	\$ 22.00 ea.
5 inch	26.00 ea.
6 inch	30.00 ea.

Convenient Operating Controls and Accessories

Vacuum Gauges: The ion pump power supply acts as its own high vacuum gauge. An ionization gauge is provided for reading high vacuum levels in the diffusion pump system. Both systems use a thermocouple gauge for roughing vacuums.

Temperature Control: Indicating on-off pyrometer, coupled with an easily replaceable chromel-alumel thermocouple, controls temperature within close limits. Other types of controllers, including programmed heating schedules and extra-precise controls, will be quoted on request.

Fast Cooling: Accessory feature reduces temperature from 1200°C to near ambient in about ten minutes. Muffle insulation opens with clamshell action, and a forced-air fan blows a cool air blast over the thermal tube to carry away the heat.

Timing Control: Optional process timing control automates the heating cycle, assures accurate control of time at preset temperature, frees operator from constant checking of the furnace. Operator sets control for the desired period at preset temperature. Timer starts when furnace heats to the temperature set. Furnace shuts off at conclusion of the preset period. Timer energizes a 110v outlet at end of heating cycle for use with audio or visual signal. Automatic cooling cycle is available as accessory equipment.

Convertible to Gas Atmosphere Use

Here is a *unique* feature of Stewart Vacuum Furnaces. With an inexpensive conversion kit, the user can readily convert his unit to the controlled atmosphere or air mode. Once installed, the kit enables the user to alternate between controlled atmosphere and vacuum firings routinely in about two hours. Owners of Stewart Controlled Atmosphere Furnaces, in similar fashion, can convert to vacuum operation with the proper conversion kit and the addition of a pumping system. Kits can be ordered factory-installed on new furnaces, or added later by the owner. Stewart furnishes full installation instructions.

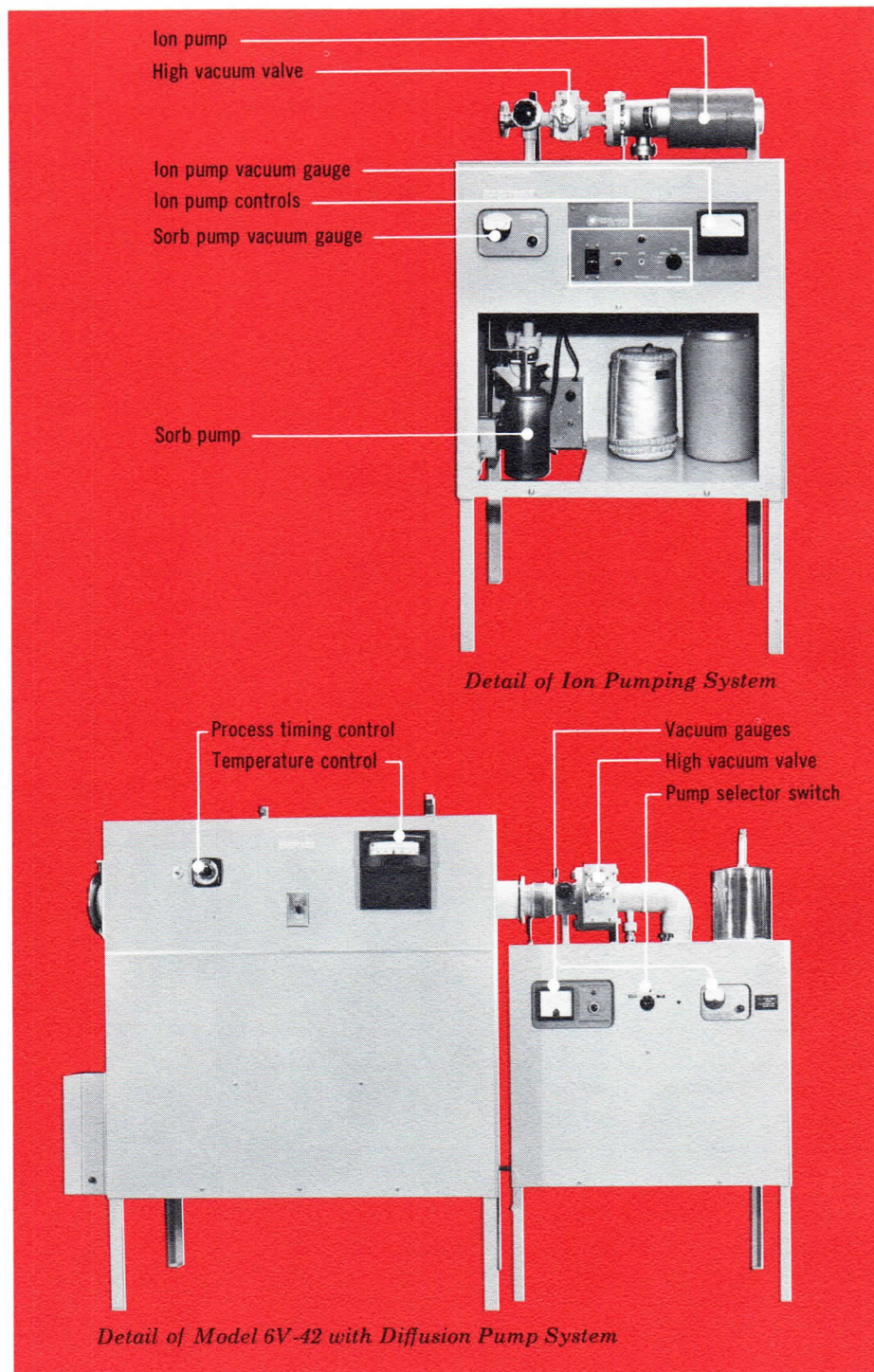

Detail of Ion Pumping System

Detail of Model 6V-42 with Diffusion Pump System

Built-in Safety Features

Stewart engineers have employed every design precaution for fail-safe furnace operation. A water flow/power interlock switch shuts off electrical power if cooling water flow is inadequate. Temperature controller automatically shuts off furnace if a failure occurs in the temperature sensing circuit.

A thermal switch on the diffusion pumping system turns off pump in case of cooling water failure. Excessive outgassing of the load during heating shuts off furnace temporarily, through interlock of vacuum pumping system and furnace controls, until the pumping system restores vacuum to a preset level. Circuit design and control locations reduce chance of operator error.

SOME KEY APPLICATIONS

Vacuum Processing: Stewart Vacuum Furnaces, with their fast pump-down rates and rapid heating and cooling characteristics, are particularly suitable for vacuum processing involving batch operations.

Outgassing of Residual Gasses: Residual gasses trapped in metal and

ceramic parts are outgassed efficiently in Stewart Vacuum Furnaces.

Vacuum Brazing: Active metals such as titanium can be brazed in a Stewart Vacuum Furnace without forming hydrides that occur in hydrogen brazing. Other metals can be outgassed and brazed in one operation.

Vapor Deposition: Stewart Vacuum Furnaces are highly adaptable to vapor deposition applications. The exceptionally high vacuums attainable combine with the 1200°C maximum temperature to encompass the vapor points of many metals.

TABLES OF SPECIFICATIONS

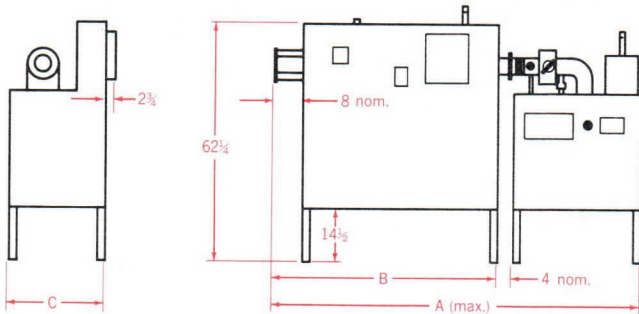

STEWART VACUUM FURNACES

MODEL		3V-24	5V-42	6V-42
DIMENSIONS (INCHES)	A	75	95	95
	B	38	59	59
	C	21 $\frac{1}{8}$	24 $\frac{3}{4}$	24 $\frac{3}{4}$

QUARTZ TUBE LENGTH

MODEL		3V-24	5V-42	6V-42
QUARTZ TUBE LENGTH	QUARTZ TUBE LENGTH	40	60	60
	O.D.	2 $\frac{3}{8}$	4 $\frac{1}{2}$	5 $\frac{5}{8}$
	I.D.	2 $\frac{1}{8}$	3 $\frac{7}{8}$	5

CONVERSION KITS

Model	To Convert	Into	For
3K-24E	3V-24	3D-24	Atmosphere
3K-24D	3V-24	3D-24	Atmosphere
3K-24V	3D-24 or 3E-24	3V-24	Vacuum
5K-42E	5V-42	5E-42	Atmosphere
5K-42D	5V-42	5D-42	Atmosphere
5K-42V	5D-42 or 5E-42	5V-42	Vacuum
6K-42E	6V-42	6E-42	Atmosphere
6K-42D	6V-42	6D-42	Atmosphere
6K-42V	6D-42 or 6E-42	6V-42	Vacuum

VACUUM PUMP SYSTEMS

MODEL	3P-24A	3P-24B	5/6P-42A	5/6P-42B
Fore pump	sorb-type	mechanical	sorb-type	mechanical
High-vacuum pump	ion	diffusion	ion	diffusion
Rating, liter/sec.	75	100	400	720
Typical pump-down time, min.	30	30	60	30

POWER REQUIREMENTS

Using standard transformer, line voltage is 460 volts, 60 cycles, single phase. Transformers for other voltages available on special order. Double the current figures in table below for operation from 230-volt line. Pump power requirements: 110 volts, single phase, 25 amps.

MODEL	3V-24		5V-42, 6V-42		
Power	KVA MAX.	7.0	33		
	KVA MIN.	4.0	15		
CURRENT (Amperes)	HEATING TIME TO 1100°C (Minutes)		CURRENT (Amperes)	HEATING TIME TO 1100°C (Minutes)	
Primary Tap	#1	14.2	7.8	72	6.5
	#2	12.8	9.8	62.5	8
	#3	11.3	11.7	50	11
	#4	8.6	23.5	44	11.5
	#5	—	—	33.5	15.5

STEWART MONO-TUBE MUFFLE

MODEL	3V-24	5V-42, 6V-42
HEAT DISTRIBUTION* (using heat baffles) Degrees C	1030° 1040° 1070° 1080° 1070° 1045° 1030°	1000° 1080° 1080° 1100° 1080° 1020° 1000°
	12"	21"
	18"	21"

*Flatter heat zones are available on special order.

STEWART
ENGINEERING COMPANY
SUBSIDIARY OF WATKINS-JOHNSON COMPANY
SANTA CRUZ • CALIFORNIA • (408) 426-4100

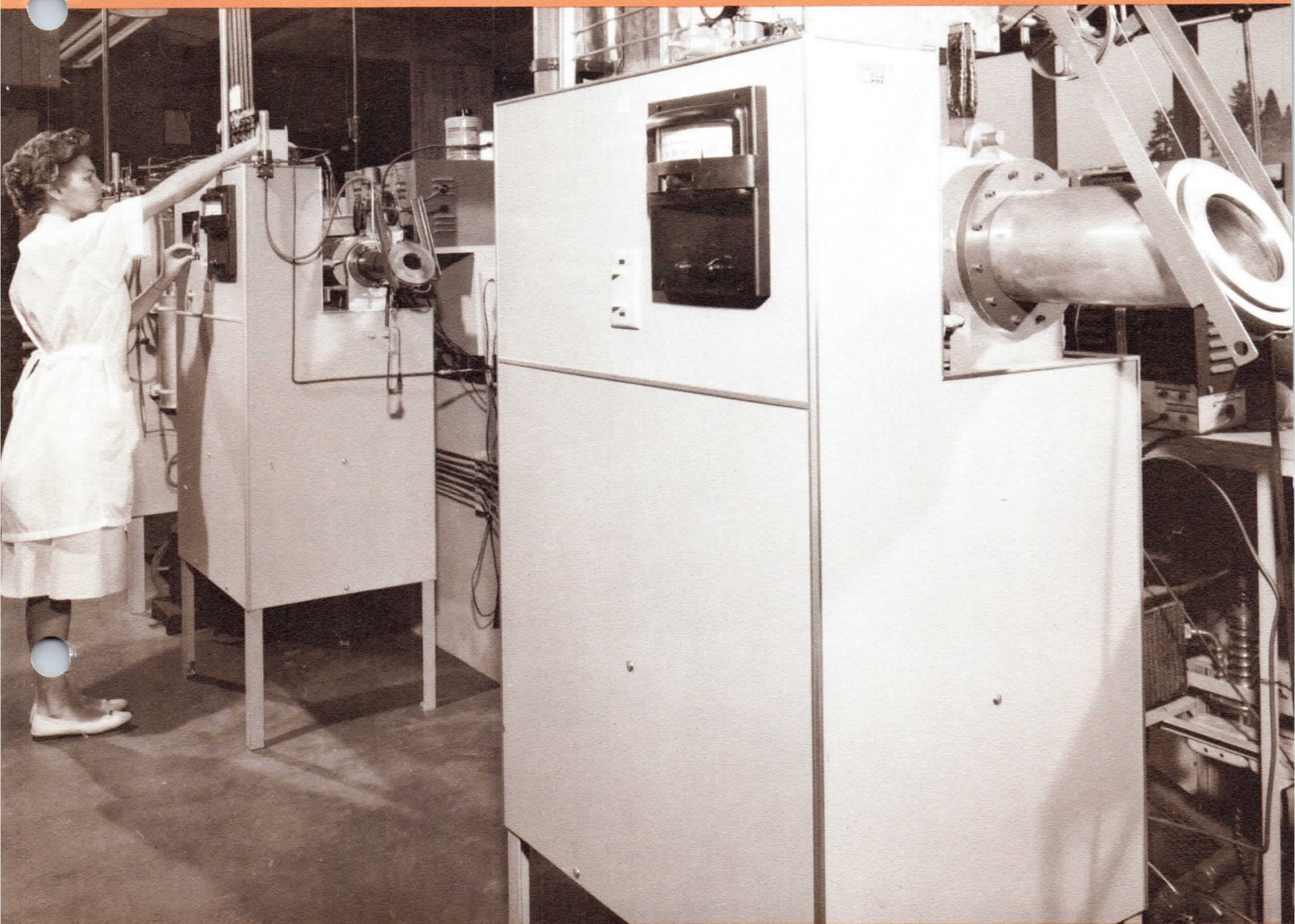

STEWART CONTROLLED ATMOSPHERE FURNACES

- **OXIDE-FREE, FLUXLESS BRAZING**
- **CERAMIC AND METAL SEAL PRODUCTION**
- **HEAT TREATING AND ANNEALING**
- **CLEANING**
- *Faster Heating*
- *Faster Cooling*
- *Lower Operating Cost*
- *Batch or Continuous Processing*

key to faster heating, simpler maintenance

STEWART MONO-TUBE ONE-PIECE MUFFLE

Secret of the Stewart furnace's high efficiency and low operating cost is the use of a simple, rugged, one-piece thermal tube in place of the conventional wire-wound ceramic muffle. Because there is considerably less mass to be heated, and because the thermal conductivity of the metal is much greater than that of ceramic muffle materials, the Stewart Mono-Tube muffle heats much more rapidly and uniformly. Typical heating speed from room temperature to 1200°C is less than 10 minutes. Cooling is equally fast (see below).

The muffle — a seamless tube of a stable nickle-

chromium-iron alloy — is highly resistant to both physical and thermal shock. It serves as a high-current, low-voltage resistance load across the secondary of a specially-designed heavy-duty transformer. The muffle's electrical terminals and work exit section are water-cooled, and accidental operation without water circulation is prevented by a water-pressure interlock switch. The muffle is easy to keep clean and easy to outgas. Its life expectancy is hundreds of heating cycles, even at maximum recommended temperatures. Flanged, bolted construction makes replacement a simple matter.

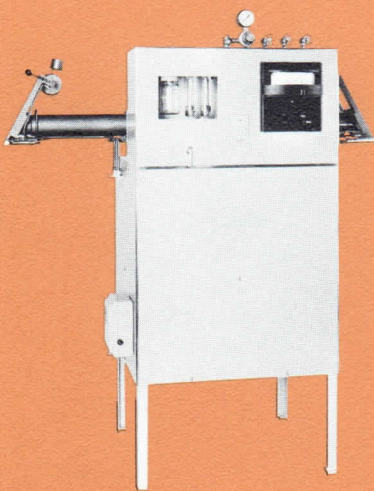

Model 3D-24 fast-heating Stewart furnace with water-cooled exit chamber.



Model 3E-24 incorporates fast-cooling features; does not have exit chamber.

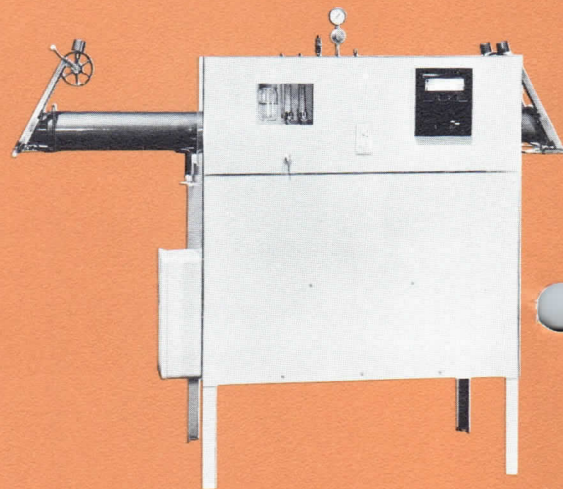

Model 6D-42 is also available as 6E-42 with fast-cooling features.

Fast cooling — over 100°C per minute

Stewart Series E furnaces are provided with special super-fast cooling features, permitting cooling from 1200°C to 80°C in less than 10 minutes. The muffle insulation opens with clam-shell action, and a built-in forced-draft blower provides rapid air circulation to carry away the heat quickly.

Large, uniform hot zone

The work area in Stewart controlled atmosphere furnaces provides exceptional uniformity and size, occupies from 60% to 80% of the overall length of the muffle. The water-cooled exit section incorporated in D series furnaces permits cooling of the finished work while the balance still remains in the "hot zone."

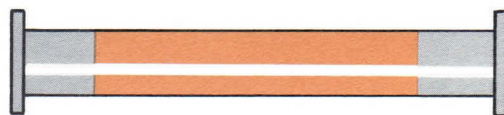
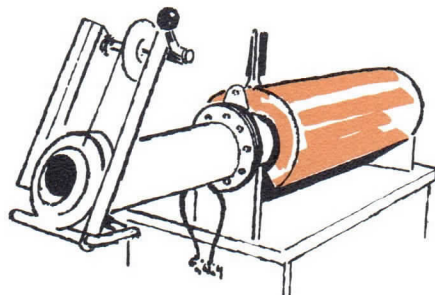
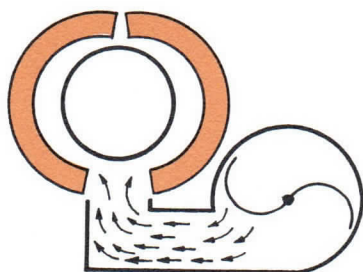

Effective July 1, 1963

PRICE SCHEDULE

Controlled Atmosphere Furnaces

Model	Price	Options		Crating (If required)
		Fast-Cooling Feature	Time Control	
3D-24	\$3,575.00	\$245.00	\$125.00	\$150.00
3E-24	3,275.00	Included	125.00	150.00
3D-36	4,375.00	275.00	125.00	170.00
3E-36	3,825.00	Included	125.00	170.00
5D-42	5,555.00	285.00	125.00	190.00
5E-42	5,175.00	Included	125.00	190.00
6D-42	6,550.00	295.00	125.00	190.00
6E-42	6,115.00	Included	125.00	190.00

NOTES:

1. Terms are net 30 days, F.O.B. Santa Cruz, California. All prices are subject to change without notice.
2. The "D" models are designed for continuous-flow operation. They have a water-jacketed cooling section and two doors with flame curtains, but not the fast-cooling feature. This feature is available as an option.
3. The "E" models are intended for batch operation. They have the fast-cooling feature but only one door, no flame curtain and no cooling section.
4. Temperature controller supplied is an on-off type with 1% accuracy. Available at an extra cost of \$145.00 is a $\frac{1}{2}$ % proportional-type controller which prevents overshoot and provides more accurate control. Other controllers are available on special order.
5. Crating is required for shipment by rail or motor freight. Skids, required for shipment by moving van, are furnished at no additional cost. (Moving van is recommended for all shipments except 5-inch and 6-inch furnaces going to the East Coast.)

STEWART
ENGINEERING COMPANY
SANTA CRUZ ■ CALIFORNIA

LOADING PLATFORM

A New Accessory, For Use With All

STEWART CONTROLLED ATMOSPHERE FURNACES

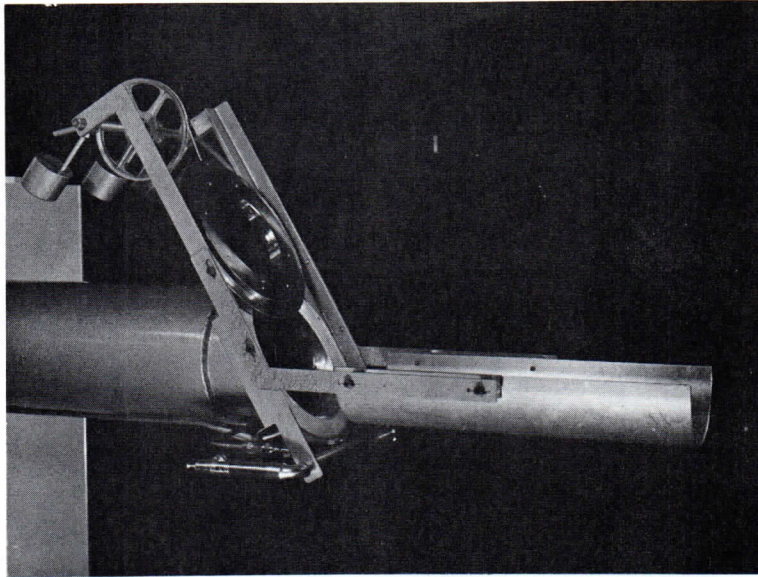

Increased Ease of Operation

Faster Loading When Using Furnace for
Push Through Firing

Saving of Gases Through Faster Loading

Easy Mounting to Existing Furnaces

Available to Install On Existing Models
Or As An Optional Accessory On New Furnaces

PRICE

3 inch	\$ 22.00 ea.
5 inch	26.00 ea.
6 inch	30.00 ea.

Closely controlled furnace atmosphere

Stewart controlled atmosphere furnaces are designed to provide a safe, reliable processing environment, with either an air atmosphere, a single gas, or a controlled mixture of gases within the muffle. Twin flow meters monitor the gas flow into the muffle. A water-bubbler type humidifier, controlled with a 2-way valve, permits the selection of either a dry or a humidified atmosphere. For example, the furnace enables stainless steel brazing in a dry hydrogen atmosphere.

Loading and unloading ends of the furnace are equipped with counterbalanced sliding doors as noted in the illustration at right. Gravity seals insure safe closure of the doors. Large mica viewing ports permit inspection of work in process.

A flame curtain is provided at each door, and is automatically switched on or off when the door is raised or lowered. The burner for each curtain is controlled by a separate valve, and a pilot insures curtain ignition.

Accurately controlled furnace temperature

The internal temperature of the muffle is brought to the desired operating temperature and held within close limits by an indicating pyrometer controller. If desired, the controller can be used to turn off the furnace automatically as soon as the required temperature is reached. The temperature sensing element is an easily replaceable thermocouple.

Because the furnace is provided with an adjustable power input (a tapped primary on the power transformer), it is possible to vary the heating time within wide limits. Various types of pyrometer controllers, other than that shown, are available to provide rough or precise temperature control, or to accommodate special types of processing schedules.

Power on-off and temperature set-point controls are located on the front panel. Operation of the pyrometer is fail-safe.

Easy installation

Stewart controlled atmosphere furnaces are shipped complete with all required accessories, and need only to be connected to power, gas, and water supply to be placed in operation. Connections for gas and water are provided at the top of the cabinet, with pressure regulator and gauge as shown. See table on page 4 for power requirements.

The Stewart furnace is finished in air-dried silver-grey enamel, trimmed with anodized aluminum. Surfaces exposed to heat are unpainted.

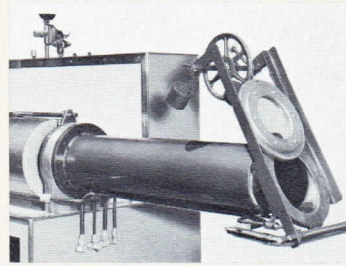

Detail of counter-balanced sliding door; raising automatically actuates valve controlling fire curtain.

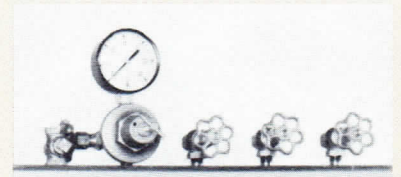

Pressure regulator, gauge, and terminals for gas and water entrance.

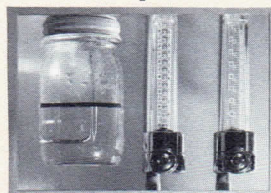
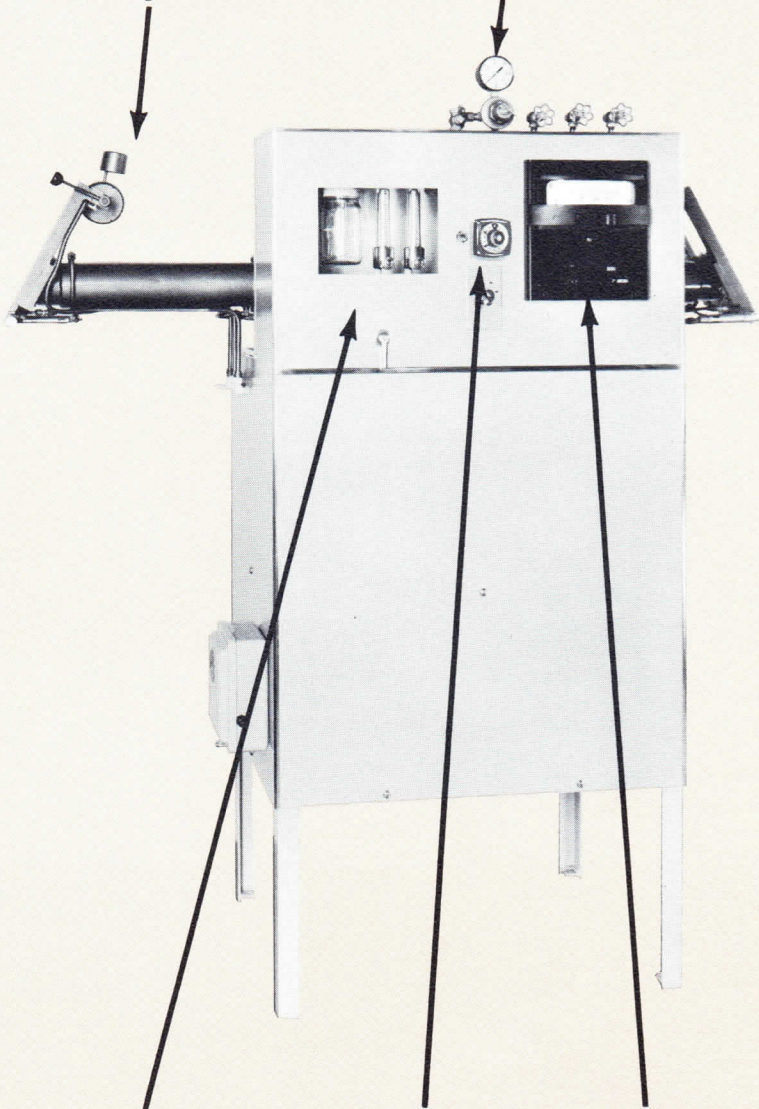

Detail of humidifier and dual flow meters.

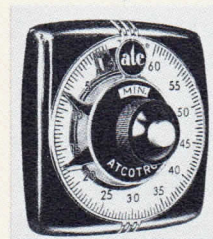

Process timing control automates heating cycle (optional)

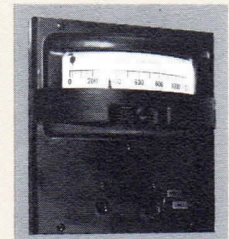

Fail-safe indicating pyrometer temperature controller.

TABLE OF SPECIFICATIONS

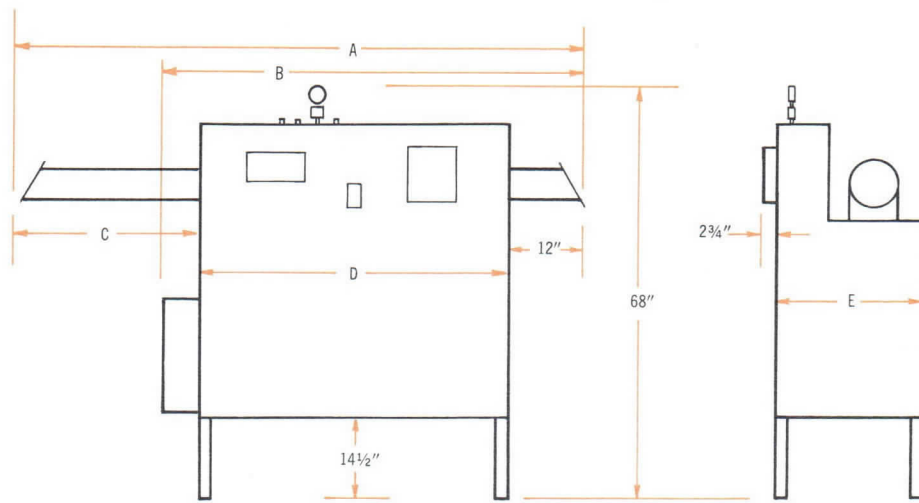

STEWART CONTROLLED ATMOSPHERE FURNACES

MAXIMUM TEMPERATURES:
 INTERMITTENT — 1200°C
 CONTINUOUS — 1150°C

MODEL		3D-24	3E-24	3D-36	3E-36	5D-42	5E-42	6D-42	6E-42
DIMENSIONS (INCHES)	A	60 ³ / ₈	N.A.	82 ⁵ / ₈	N.A.	92 ⁵ / ₈	N.A.	92 ⁵ / ₈	N.A.
	B	N.A.	45 ³ / ₈	N.A.	60 ¹ / ₈	N.A.	69 ¹ / ₂	N.A.	69 ¹ / ₂
	C	18 ¹ / ₂	N.A.	27 ¹ / ₂	N.A.	29 ¹ / ₂	N.A.	29 ¹ / ₂	N.A.
	D	29 ⁷ / ₈		43 ¹ / ₈		50 ⁵ / ₈			
	E	21 ¹ / ₈				24 ³ / ₈			
MUFFLE LENGTH	24"		36"		42"				
O.D.	3"			5"			6 ¹ / ₄ "		
I.D.	2 ⁷ / ₈ "			4 ³ / ₄ "			6"		

POWER REQUIREMENTS AND HEATING TIME TO 1100°C

Using standard transformer, 460 volt, 60 cycle, single phase

(transformers for other voltages available on special order). Double the current figures below for operation from 230-volt line.

MODELS		3D-24 & 3E-24		3D-36 & 3E-36		5D-42, 5E-42, 6D-42 & 6E-42	
MUFFLE HEAT DISTRIBUTION Degrees C							
		CURRENT (Amperes)	HEATING TIME (Minutes)	CURRENT (Amperes)	HEATING TIME (Minutes)	CURRENT (Amperes)	HEATING TIME (Minutes)
PRIMARY TAP	#1	14.2	7.8	29	12	72	6.5
	#2	12.8	9.8	19	30	62.5	8
	#3	11.3	11.7	14	40	50	11
	#4	8.6	23.5	11	79	44	11.5
	#5	—	—	—	—	33.5	15.5
POWER	KVA MAX.	7.0		15.0		33	
	KVA MIN.	4.0		5.0		15.0	

TECHNICAL PAPERS AVAILABLE UPON REQUEST

- "A Method for Accurately Measuring Noise Figure"
- "Some Factors in Choosing a Low-Noise Traveling-Wave Tube"
- "Traveling-Wave Tube With 1.7 db Noise Figure in L-Band"
by B. P. Israelsen and R. W. Peter
- "The Effect of Helix Loss on Noise Figure in Traveling-Wave Tubes"
by B. P. Israelsen
- "Technique for Dynamic Measurement of Differential Phase Shift"
by B. P. Israelsen and R. W. Haegele
- "Broadband Electronically-Tuned Microwave Devices"
by K. L. Kotzebue
- "Present Status of Low-Noise Traveling-Wave Tubes and Future Possibilities"
by R. W. Peter
- "Amplifier Sweeper for Electronically-Tuned YIG Devices"
Applications Engineering Note
- "Nonreciprocity in YIG Filters"
Applications Engineering Note
- "New Transmitting and Receiving Devices for Millimeter Wavelength"
by H. R. Johnson, E. W. Kinaman, K. L. Kotzebue, R. D. Frost,
R. W. Peter, O. T. Purl, J. W. Sedin and D. A. Watkins
- "A PM-Focused Ultra Low-Noise Traveling-Wave Tube for S-Band"
by B. P. Israelsen and R. W. Peter
- "A Wide-Range, Electronically-Tuned Tunnel Diode Microwave Oscillator"
by K. L. Kotzebue
- "Low-Power Ferrite Limiters"
by K. L. Kotzebue
- "A 100 Gc High-Power Backward-Wave Oscillator"
by J. W. Sedin
- "Practical Laser Operation and Application"
Applications Engineering Note
- "Electron Guns for Forming Solid Beams of High Perveance and High Convergence"
by R. D. Frost, O. T. Purl and H. R. Johnson
- "Technical Notes WJ-111/112 - WJ-113/114"
- "Progress in Low-Noise Traveling-Wave Tube Development"
by B. P. Israelsen and R. W. Peter
- "WJ-268 Series, 1.0 to 2.6 Gc Low-Noise Permanent-Magnet Traveling-Wave
Tube with Integral Power Supply"
Applications Engineering Note

November, 1963
Watkins-Johnson Company

WATKINS-JOHNSON ELECTRON DEVICES

CONTENTS

Quick Reference Catalog

Ultra Low-Noise Tubes

Noise Generators

Missile and Space Tubes

High Power Tubes

Electronically Tunable Filters

TABLE OF CONTENTS

W-J Electron Devices

	<u>Effective Date</u>
Quick Reference Catalog	August, 1963
<i>WJ-307, TWT</i> Laser, WJ-283, Vol. 5, No. 10	October, 1963
<i>Helium-Neon DC-Pumped Gas Laser - WJ-316</i> <u>Ultra Low-Noise Tubes</u>	<i>Sept. 1964</i>
WJ-211, WJ-212, Family of, Vol. 2, No. 6	November, 1960
WJ-221, Vol. 3, No. 7	July, 1961
WJ-257, Vol. 5, No. 8	August, 1963
WJ-268, Vol. 5, No. 2	March, 1963
WJ-268-2, Vol. 5, No. 6	August, 1963
WJ-269, Vol. 5, No. 3	March, 1963
WJ-269-1, Vol. 5, No. 7	August, 1963
WJ-276, Vol. 5, No. 9	October, 1963
WJ-280, Vol. 5, No. 11	November, 1963
 <u>Noise Generators</u>	
WJ-218, Vol. 3, No. 8	August, 1961
 <u>Missile and Space Tubes</u>	
WJ-217, Vol. 4, No. 7	September, 1962
WJ-237, Vol. 4, No. 6	August, 1962
 <u>High Power Tubes</u>	
WJ-228, Vol. 5, No. 5	August, 1963
 <u>Electronically Tunable Filters</u>	
YIG Filters and Devices Catalog	January, 1964
<i>WJ-135 Sensed</i> <i>WJ-165, 166, 167, 168</i> <u>Band Pass</u>	<i>MARCH 1964</i> <i>JULY 1964</i>
WJ-501, Vol. 3, No. 10	September, 1961
WJ-505, Vol. 4, No. 5	June, 1962
WJ-506, Vol. 4, No. 8	October, 1962
 <u>Frequency Selective Limiters</u>	
WJ-507, Vol. 4, No. 2 (Low-Power Ferrite Limiters)	March, 1962
WJ-519, Vol. 4, No. 10	October, 1962

Information contained herein is subject to change without notice. It should not be used without the advice of Watkins-Johnson Applications Engineering regarding the current technical status of the item described. Any further inquiries should be addressed to Applications Engineering or our representative in your area.

November, 1963
Watkins-Johnson Company

QUICK REFERENCE CATALOG

QUICK
REFERENCE
CATALOG
March / 1965

LOW-NOISE TRAVELING-WAVE TUBES





LOW-NOISE TRAVELING WAVE TUBES

NOISE FIGURE VS FREQUENCY

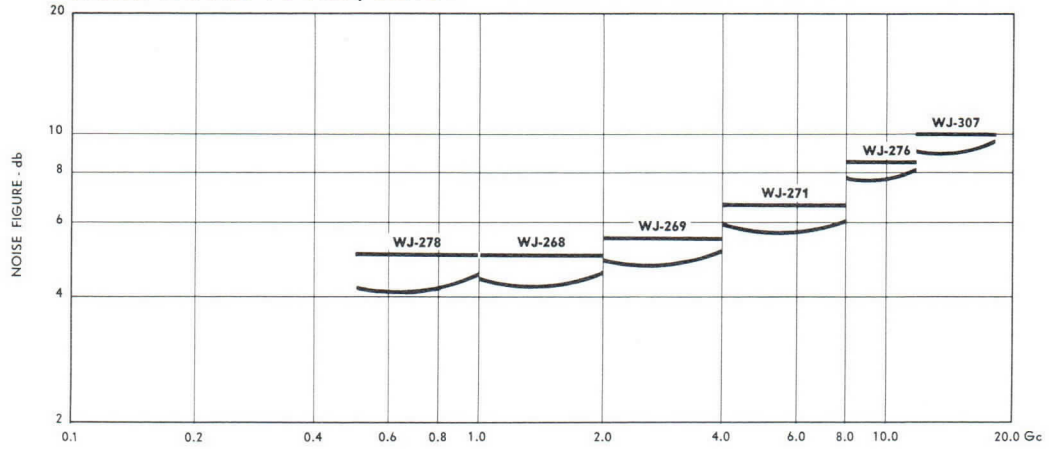

ULTRA
LOW-NOISE
AMPLIFIERS

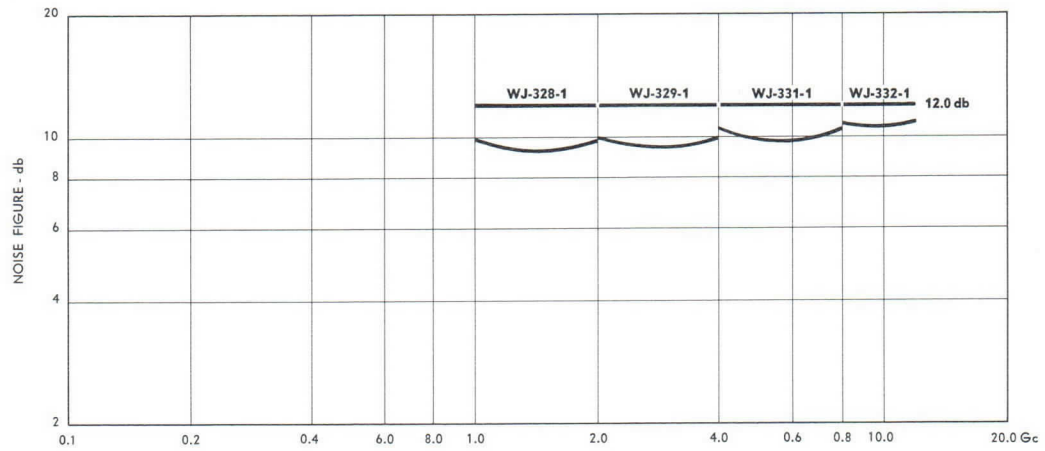
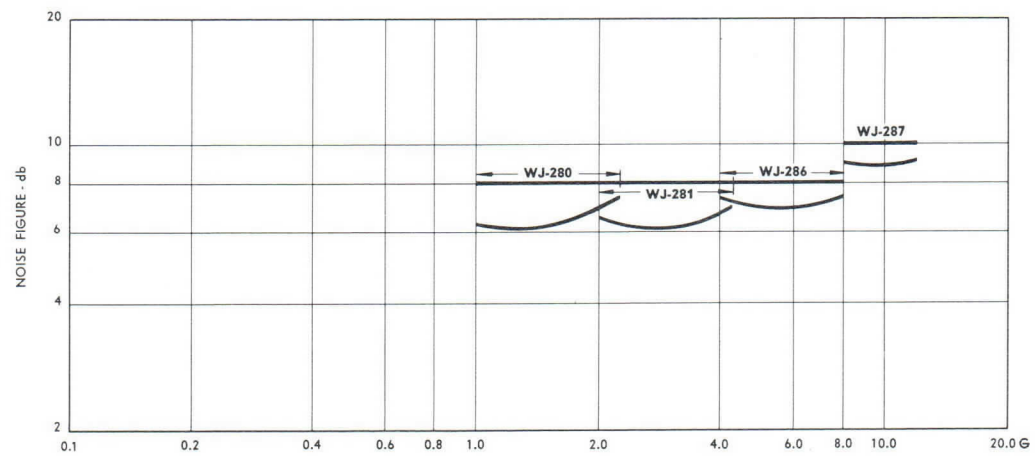

MINIATURE
LOW-NOISE
AMPLIFIERS

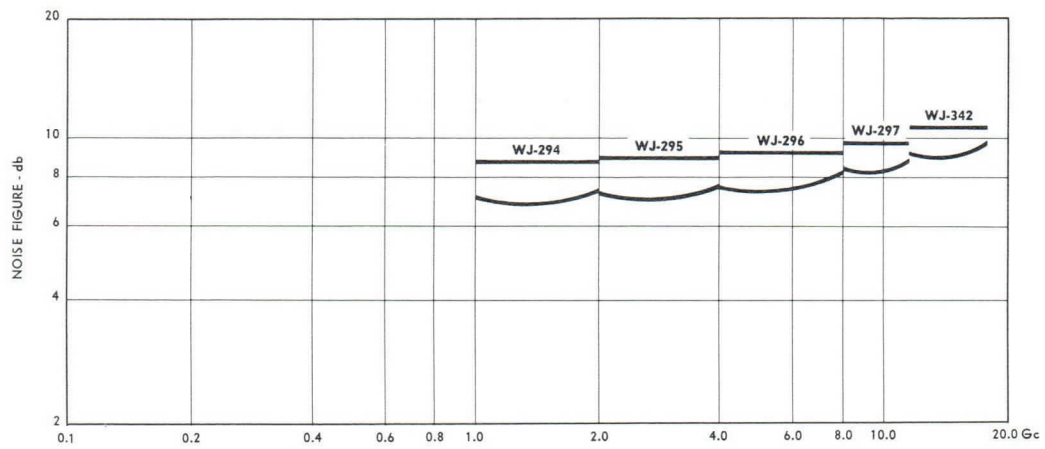

**ENVIRONMENTAL CHARACTERISTICS ON ALL LISTINGS BELOW MEET OR EXCEED
THE RESPECTIVE REQUIREMENTS OF MIL-E-5400 CLASS II**

TYPE	FREQUENCY RANGE	NOISE FIGURE (Maximum)	CHARACTERISTICS
WJ-278	0.5 - 1.0 Gc	5.0 db	Gain 25 db Min. Size 5" high x 12" long Weight 17 lbs. Integral Power Supply (115 V ± 10 V, 48-420 cps)
WJ-268	1.0 - 2.0 Gc	5.0 db	
WJ-269	2.0 - 4.0 Gc	5.5 db	
WJ-271	4.0 - 8.0 Gc	6.5 db	
WJ-276	8.0 - 12.0 Gc	8.5 db	
WJ-307	12.0 - 18.0 Gc	10.0 db	
WJ-280	1.0 - 2.6 Gc	8.0 db	Gain 35 db Min. Size 5" high x 12" long Weight 17 lbs. Integral Power Supply (115 V ± 10 V, 48-420 cps)
WJ-281	2.0 - 4.5 Gc	8.0 db	
WJ-286	4.0 - 8.0 Gc	8.0 db	
WJ-287	8.0 - 12.0 Gc	10.0 db	
WJ-328-1	1.0 - 2.0 Gc	12.0 db	Gain 35 db Min. Size 4.75" high x 12" long Weight 17 lbs. Sat. Power + 10 dbm Min. Integral Power Supply (115 V ± 10 V, 48-420 cps)
WJ-329-1	2.0 - 4.0 Gc	12.0 db	
WJ-331-1	4.0 - 8.0 Gc	12.0 db	
WJ-332-1	8.0 - 12.0 Gc	12.0 db	
WJ-294	1.0 - 2.0 Gc	8.0 db	Gain 25 db Min. Size 3.4" high x 9.5" long Weight 5 lbs. Sat. Power + 7 dbm Min. Integral Power Supply (115 V ± 10 V, 48-420 cps)
WJ-295	2.0 - 4.0 Gc	8.5 db	
WJ-296	4.0 - 8.0 Gc	9.0 db	
WJ-297	8.0 - 12.0 Gc	9.5 db	
WJ-342	12.0 - 18.0 Gc	11.0 db	

- All amplifiers employ permanent-magnet focusing structure, are adjustment free and require only AC line voltage input
- All units are completely shielded and may be operated in stacked arrays or next to ferromagnetic material without adverse effect
- Environmental temperature range of operation is -54°C to $+85^{\circ}\text{C}$
- Environmental shock is (a) 0.10 in double amplitude to 5 to 45 cps
(b) 10 G single amplitude 45 to 2000 cps
- Environmental vibration is 15 G, 11 m sec.
- All units are available with AGC option
- Special amplifiers are available featuring improved noise figures over narrow frequency ranges. (For example: 8.5 - 9.6 Gc, 5.5 db noise figure; 2.2 - 2.3 Gc, 3.5 db noise figure)
- A unique blanking circuit is available, allowing pulse times on the order of a few nanoseconds
- Extended and special frequency coverage amplifiers are available on special order. (For instance: 2.0 - 8.0 Gc, 10.0 - 20.0 Gc)
- Units can be provided with rigid differential phase and gain specifications

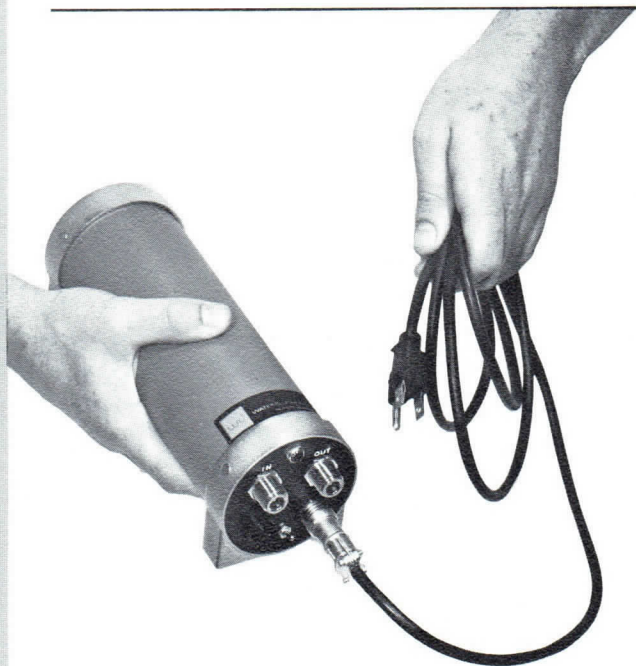

THE LOW-NOISE AMPLIFIERS manufactured by Watkins-Johnson Company are the result of extensive practical experience obtained through research, development and production of traveling-wave tubes, coupled with adoption of solid-state regulated power supplies. Entirely adjustment-free, these amplifiers are completely self-contained and highly reliable.

The concept of these amplifiers is unique. It was pioneered at W-J and consists of a low-noise TWT, focusing structure, coupler assembly, and solid-

state power supply built into a single package. Since all adjustments required to assure optimum performance and long life are made during production—using precision equipment that is regularly calibrated — performance is assured at points of application.

A life test program was begun in January of 1963 and is still under way. As of early 1965, several tubes had accrued greater than 17,000 hours. Based on this kind of life test, an MTBF of greater than 19,400 hours can be easily realized. The life test program supplements more than two years of field practice with these amplifiers. The return rate has been extremely low.

WARRANTY INFORMATION

Normal warranty on all low-noise traveling-wave tubes with integral power supplies is for a period of one year from the date of purchase or 3500 hours—1000 hours unconditional and an additional 2500 hours prorated.



WATKINS-JOHNSON COMPANY was formed in December, 1957, to engage in research, development, and production of advanced electron devices and related electronic systems and equipments. It now occupies a 23-acre site in Stanford Industrial Park, adjacent to Stanford University, and the 30-acre site of its Stewart Division, near Santa Cruz, California. A major financial interest is owned by the Kern County Land Company, a major diversified organization incorporated in 1890.

Watkins-Johnson is deeply involved in advancing the state of the art in the fields of microwave electron-beam and solid-state devices, as well as optical-frequency devices. Programs range from low-noise to high-power and cover frequencies from 250 Mc through visible light. Production of low-noise traveling-wave tubes, YIG filters, medium-power traveling-wave tubes, and backward-wave oscillators accounts for a large part of the company's manufacturing effort.

NORTHWEST

Rush S. Drake Associates, Inc.

6133 Maynard Avenue South
Seattle (Tel. 206-PA5-2700)

WEST

Applications Engineering

Watkins-Johnson Company
3333 Hillview Avenue
Palo Alto (Tel. 415-326-8830)

SOUTHWEST

Bennewitz Associates

8310 Cutler NE
Albuquerque (Tel. 299-8651)

Kemco, Inc.

11520 Burdine
Houston (Tel. 713-MO7-1409)

P.O. Box 998
Irving, Texas (Tel. 214-BL3-6703)

MIDWEST

Kemco, Inc.

6115 E. 13th
Wichita, Kansas (Tel. 316-MU4-8224)

Scientific Sales Co.

7132 N. Harlem Avenue
Chicago (Tel. 312-775-7595)

24 Pheasant Lane
St. Paul (Tel. 612-484-8022)

S. Sterling Co.

21250 10 1/2 Mile Road
Southfield, Mich. (Tel. 313-442-5656)

NORTH CENTRAL

5827 Mayfield Road
Cleveland (Tel. 216-HI2-8080)

3300 South Dixie Drive
Dayton (Tel. 513-AX8-7573)

4232 Brownsville Road
Pittsburgh (Tel. 412-TU4-5515)

Lancer Associates

442 Marrett Road
Lexington, Mass. (Tel. 617-VO2-7782)

Eastern Instrumentation, Inc.

350 Northern Boulevard
Great Neck, L.I. (Tel. 516-466-9505)

613 Cheltenham Avenue
Philadelphia (Tel. 215-WA7-6269)

1002 Ingleside Avenue
Baltimore (Tel. 301-RI4-3675)

Ossmann Instruments, Inc.

3100 Monroe Avenue
Rochester (Tel. 716-LU6-0380)

101 Pickard Drive
Syracuse (Tel. 315-GL4-2461)

Vestal Parkway East
Vestal, N.Y. (Tel. 607-ST5-9947)

M. J. McDonald Co., Inc.

310 West Third Street
Burlington, N.C. (Tel. 919-226-7177)

2610 Seabreeze Court
Orlando (Tel. 305-422-0039)

Route No. 1
Pfafftown, N.C. (Tel. 919-924-2182)

1000 Airport Road, F-8
Huntsville, Ala. (Tel. 205-881-5043)

Maurice I. Parisier Co.

741-745 Washington Street
New York (Tel. 212-AL5-8900)

Relations Techniques Intercontinentales

134 Avenue de Malakoff
Paris XVI (Tel. Passy 43-09)

Dale Electronics Limited

109, Jermyn Street
London, SW1 (Tel. Whitehall 4856)

AB Nordiska Elektronik

John Ericssonsgatan 12 to 14
Stockholm K (Tel. 08/24 83 40)

A/S Nordisk Elektronik

Danasvej #2
Copenhagen V (Tel. EVA 8285)

EAST

SOUTHEAST AND SOUTH

EXPORT

QUICK
REFERENCE
CATALOG

August / **1963**

TRAVELING-WAVE TUBES



TRAVELING-WAVE TUBE QUICK REFERENCE CATALOG

ULTRA LOW-NOISE TUBES

TYPE	Frequency (Gc)	Power Output	Gain (db)	Noise Figure (db)	Helix Voltage (volts)
WJ-221	0.25- 0.50	— 5 dbm	28	4.0	50
WJ-212	1.0 - 2.0	— 10 dbm	25	4.0	140
WJ-212-1	1.1 - 1.6	— 10 dbm	25	3.6	140
WJ-212-2	1.0 - 2.0	— 10 dbm	25	4.0	140
WJ-226	1.4 - 2.3	— 10 dbm	25	4.3	140
WJ-211	2.0 - 4.0	— 10 dbm	25	4.3	175
WJ-211-1	2.1 - 2.4	— 10 dbm	25	3.5	175
WJ-211-2	2.3 - 2.7	— 10 dbm	25	3.4	175
WJ-211-3	2.5 - 3.5	— 10 dbm	25	3.9	175
WJ-211-4	2.2 - 2.3	— 10 dbm	25	3.4	175
WJ-211-5	2.0 - 4.0	— 10 dbm	25	4.3	175
WJ-211-6	3.55- 3.7	— 10 dbm	25	3.9	175
WJ-278	0.5 - 1.0	— 5 dbm	28	4.5	
WJ-268	1.0 - 2.0	— 5 dbm	28	4.5	
WJ-280	1.0 - 2.6	— 5 dbm	35	7.0	
WJ-269	2.0 - 4.0	— 5 dbm	28	5.0	
WJ-281	2.0 - 4.5	— 5 dbm	35	7.0	
WJ-271	4.0 - 8.0	— 3 dbm	28	5.5	
WJ-276	8.0 -12.0	0 dbm	28	7.5	
WJ-257	12.0 -18.0	+ 3 dbm	25	9.0	760
WJ-258	26.0 -40.0	+ 3 dbm	25	13.0	900

NOISE GENERATORS

WJ-218	2.0 - 4.0	2 mw integrated	—	—	265
--------	-----------	-----------------	---	---	-----

MISSILE AND SPACE TUBES

TYPE	Frequency (Gc)	Power Output (w)	Gain (db)	Helix Voltage (volts)
WJ-237	1.7 - 2.0	2.5	33	770
WJ-227	2.0 - 2.4	12	40	1600
WJ-217	2.0 - 4.0	15	30	2300
WJ-238	3.8 - 4.1	25	35	2500
WJ-239	4.5 - 5.5	25	30	2700
WJ-251	7.0 - 8.5	2.5	35	Grounded 1700
WJ-231	7.0 - 8.25	35	35	Grounded 3500

HIGH POWER TUBES

TYPE	Frequency (Gc)	Power Output (kw)	Gain (db)	Body-Collector Voltage (volts)	Collector Current (a)
WJ-277	0.7 - 1.1	10	40	Grounded	4
WJ-234	1.09- 1.49	100	15	24,000	13
WJ-228	5.41- 5.91	18	50	Grounded	3
WJ-206	8.4 - 9.4	10	50	Grounded	4
WJ-266	34.77-35.23	1	10	Grounded	0

Note¹ For optimum system performance operate in WJ-SL1 Solenoid.

Note² For optimum system performance operate in WJ-SL2 Solenoid.

The above information is for detailed information contact our representative, 3333 Hill



TYPICAL SPECIFICATIONS

Collector Voltage (volts)	Anode Voltages (volts)					Cathode Current	Duty Factor	Magnetic Field Strength (gauss)	Weight (lb)	Length (in)	Diameter (in)
	1	2	3	4	5						
500	3	1	10	30	—	300 μ a	cw	Solenoid ²	2.3	18 $\frac{1}{2}$	1 $\frac{3}{8}$
700	3	2	10	50	—	50 μ a	cw	Solenoid ¹	2.3	18 $\frac{1}{2}$	1 $\frac{3}{8}$
700	3	2	10	50	—	50 μ a	cw	Solenoid ¹	2.3	18 $\frac{1}{2}$	1 $\frac{3}{8}$
700	3	2	10	50	—	50 μ a	cw	Solenoid ¹	2.3	20	1 $\frac{3}{8}$
700	3	2	10	50	—	50 μ a	cw	Solenoid ¹	2.3	18 $\frac{1}{2}$	1 $\frac{3}{8}$
700	3	2	10	60	—	40 μ a	cw	Solenoid ¹	2.3	18 $\frac{1}{2}$	1 $\frac{3}{8}$
700	3	2	10	60	—	40 μ a	cw	Solenoid ¹	2.3	18 $\frac{1}{2}$	1 $\frac{3}{8}$
700	3	2	10	60	—	40 μ a	cw	Solenoid ¹	2.3	18 $\frac{1}{2}$	1 $\frac{3}{8}$
700	3	2	10	60	—	40 μ a	cw	Solenoid ¹	2.3	18 $\frac{1}{2}$	1 $\frac{3}{8}$
620	3	2	10	60	—	40 μ a	cw	Solenoid ¹	2.3	18 $\frac{1}{2}$	1 $\frac{3}{8}$
700	3	2	10	60	—	40 μ a	cw	Solenoid ¹	2.3	20	1 $\frac{3}{8}$
700	3	2	10	60	—	40 μ a	cw	Solenoid ¹	2.3	18 $\frac{1}{2}$	1 $\frac{3}{8}$
INTEGRAL POWER SUPPLY							cw	PM	17	12	4 $\frac{1}{2}$
							cw	PM	17	12	4 $\frac{1}{2}$
							cw	PM	17	12	4 $\frac{1}{2}$
							cw	PM	17	12	4 $\frac{1}{2}$
							cw	PM	17	12	4 $\frac{1}{2}$
							cw	PM	17	12	4 $\frac{1}{2}$
1200	4	20	60	90	560	250 μ a	cw	Solenoid	1.5	12	1
1500	-3	40	120	300	1000	250 μ a	cw	Solenoid	1.5	10	1
265	—	—	—	—	—	4.0 ma	cw	PPM	1.5	9 $\frac{1}{4}$	1 $\frac{1}{8}$

Collector Voltage (volts)	Anode Voltage (v)	Cathode Current (ma)	Duty Factor	Focus	Weight (lb)	Length (in)	Cross-Section (in)
Grounded 460	870	20	cw	PPM	1.1	9 $\frac{3}{4}$	1 $\frac{1}{4}$ x 1 $\frac{1}{2}$
Grounded 1100	1700	50	cw	PPM	2.1	13 $\frac{1}{2}$	1 $\frac{1}{2}$ x 1 $\frac{3}{4}$
Grounded 1800	2400	55	cw	PPM	6	13 $\frac{3}{4}$	1 $\frac{3}{4}$ x 1 $\frac{3}{4}$
Grounded 1900	2750	70	cw	PPM	5.5	13 $\frac{1}{2}$	1 $\frac{3}{4}$ x 1 $\frac{3}{4}$
1500	2800	65	cw	PPM	3.5	10	1 $\frac{1}{2}$ x 2
(1) 750 (2) 625	1750	15	cw	PPM	0.65	7	1 (Diameter)
(1) 1550 (2) 1300	3600	66	cw	Rev. - Field PM	14	8	5 (Diameter)

Anode Voltage	Cathode Voltage (Kv)	Cathode Current (a)	Duty Factor	Focus	Weight (lb)	Length (in)	Diameter (in)
Grounded	— 9.5	5.0	0.010	PPM	35	33	4
Grounded	Grounded	16.0	0.010	PM	18	15	4 $\frac{1}{2}$
Grounded	— 23	4.1	0.024	PPM	14	24	2 $\frac{5}{8}$
Grounded	— 28	5.0	0.010	PPM	12	19	2 $\frac{1}{4}$
Grounded	— 24	0.45	cw	Solenoid	40	18	8

ation represents typical values and is intended as a guide to our products. For more information on these and other products now under development or of a classified nature, contact your representative in your area or refer to Applications Engineering, Watkins-Johnson Company, 3200 Cowan Avenue, Stanford Industrial Park, Palo Alto, California.



WATKINS-JOHNSON COMPANY was formed in December, 1957, to engage in research, development, and production of advanced electron devices and related electronic systems and equipments. It now occupies a 23-acre site in Stanford Industrial Park adjacent to Stanford University, and a 30-acre site near Santa Cruz, California. A major financial interest is owned by the Kern County Land Company, a land and development organization incorporated in 1892 and well known in the West.

Watkins-Johnson is deeply involved in advancing the state of the art in the fields of microwave electron-beam and solid-state devices, as well as optical-frequency devices. Programs range from low-noise to high-power and cover frequencies from 250 Mc through visible light. Production of low-noise traveling-wave tubes, YIG filters, and medium-power traveling-wave tubes is now under way.

Starting in September, 1960, with the organization of a Systems Division, the widening base of technical activity has produced numerous sophisticated devices that have been employed at W-J as key elements in a variety of advanced equipments. Principal activities are in the fields of space communications, reconnaissance, surveillance, and countermeasures. Transmitters, power amplifiers, electronically tunable receivers, low-noise amplifiers, phase-stabilized receivers and transmitters, and ancillary equipment have been developed and delivered.

REPRESENTATIVES

Perlmuth Electronic Instrumentation

5057 West Washington Boulevard
Los Angeles 16 (Tel. WEbster 1-1041)
941 Charleston Road
Palo Alto (Tel. DAvenport 1-5064)
8068 Engineers Road
San Diego (Tel. BRowning 8-6230)
2859 East Thomas Road
Phoenix (Tel. AMherst 4-4934)
2745 San Mateo, N.E.
Albuquerque (Tel. AMherst 8-6797)

Lancer Associates

428 Marrett Road
Lexington 73, Mass.
(Tel. VOLunteer 2-7782)

Eastern Instrumentation, Inc.

613 Cheltenham Avenue
Philadelphia 26 (Tel. WAverly 7-6269)
350 Northern Boulevard
Great Neck, Long Island (Tel. 466-9505)
808 Ingleside Avenue
Baltimore 28, Md.
(Tel. RIdgeway 4-3676/4-3675)
Silver Spring, Md. (Tel. JUNiper 9-0100)

Ossmann Instruments, Inc.

101 Pickard Drive
Syracuse 11, N.Y. (Tel. GLenview 4-2461)
3100 Monroe Avenue
Rochester 18, N.Y. (Tel. LUDlow 6-0380)
P.O. Box 245
Vestal, New York (Tel. STillwell 5-9947)

S. Sterling Company

21250 10½ Mile Road
Southfield, Mich. (Tel. 442-5656)
5827 Mayfield Road
Cleveland, Ohio (Tel. Hillcrest 2-8080)
4232 Broonsville Road
Pittsburgh 27, Pa. (Tel. TUxedo 4-5515)
3300 S. Dixie Drive
Dayton, Ohio (Tel. AXminster 8-7573)

Kemco, Inc.

P.O. Box 998
Irving, Texas (Tel. BLackburn 3-6703)
6427 East Kellogg
Wichita, Kansas (Tel. MUrray 4-8224)
12019 Hillcroft Boulevard
Houston, Texas (Tel. MOhawk 7-1409)

EXPORTERS

Maurice I. Parisier & Co.

741-745 Washington Street
New York 14
(Tel. ALgonquin 5-8900/5-8901)

Relations Techniques Intercontinentales

134 Avenue Malakoff
Paris 16, France
(Tel. Passy 43-09)



Vol. 5, No. 10, October, 1963

WJ-283-1-2-3
HELIUM-NEON DC-PUMPED GAS LASER WITH
INTEGRAL REGULATED POWER SUPPLY

The WJ-283 offers a new concept in CW gas lasers. Completely self-contained, this miniaturized laser requires only an ac line voltage input and is adjustment-free in operation.

The WJ-283 is a DC-pumped helium-neon gas laser which provides a stable nominal output power of 1 milliwatt. Corresponding to model numbers WJ-283-1, WJ-283-2 and WJ-283-3, it is normally supplied with cavity resonators for operation at a wavelength of either 6328Å in the visible, or at 1.15 μ and 3.39 μ in the infrared range. Interchangeable mirrors which are available as optional accessories permit conversion of each unit for operation at all three wavelengths.



Like its predecessors, the WJ-270 and WJ-279, the WJ-283 offers rugged coaxial construction and excellent mechanical precision. The use of a high-gain discharge tube permits a unique, compact design. The complete laser, including the integral 117-volt ac power supply, is as small and light as a medium sized flashlight.

Special heated discharge cathodes, large gettering area and gas reservoir, as well as highest quality processing and filling techniques assure long life of the ruggedized plasma tube.

Due to its small size and low cost, the WJ-283 laser is ideally suited as an optical signal source for schools, to conduct demonstrations and experiments with monochromatic, coherent light. As a compact laboratory signal source or as an optical transmitter in the field, it will satisfy the demands for a lightweight visible, or infrared CW coherent light source.

Details of electrical and mechanical characteristics are given on the attached specification sheet.

Accessories available on special order include collimators, additional mirrors for converting any WJ-283 model for operation at other wavelengths, spherical and plane mirror combinations for hemispherical operation, a laboratory stand, an optical bench converter as well as various optical attachments.

Any further inquiries may be addressed to our Application Engineering Services or to our representative in your area.

TENTATIVE SPECIFICATION

WJ-283-1-2-3 HELIUM-NEON DC-PUMPED GAS LASER WITH INTEGRAL REGULATED POWER SUPPLY

PERFORMANCE

	WJ-283-1	WJ-283-2	WJ-283-3
Laser wavelength	6328A	1.15 μ	3.39 μ

(Interchangeable mirrors are available permitting conversion of any model to operate at any of the three wavelengths)

All Models

Output power (beam available from one end only)

1 milliwatt CW typical
.50 milliwatts CW guaranteed

OPTICAL CHARACTERISTICS

Reflectors

Multilayer-dielectric coated mirrors, greater than 99 percent reflection on cavity side. Anti-reflection coating on output side. Confocal spherical mirrors. Alignment by easily accessible precision screws.

Beam polarization

Plane polarized by effect of Brewster angle windows.

Beam diameter and divergence	.080 inches maximum. 30 arc-minutes maximum angular width.
Cavity parameters	6.00 inches spacing of reflectors. .010 plasma tube diameter to reflector spacing ratio.
Mode separation	Axial mode spacing 1000 Mc for lowest order transverse mode.

ELECTRICAL REQUIREMENTS

	<u>Typical</u>	<u>Range</u>
Primary voltage	117 v ac	117 ± 15 v ac
Primary frequency	60 cps	48 to 400 cps
Primary power	15 w	

MECHANICAL CHARACTERISTICS

Laser length*	18 in.
Laser diameter*	1.75 in.
Weight*	2 lbs. 2 ozs.
Operating position	Any
Ruggedization and environment	Good commercial standards**

RF INTERFERENCE

No rf interference
Does not apply, no rf source used
due to dc-pumping

* Including complete integral regulated power supply and starting circuit.

** Units meeting MIL spec. shock and environmental conditions are available on special order.



Vol. 7, No. 6; July, 1965*

WJ-291

HELIUM-NEON DC-PUMPED GAS LASER WITH
INTEGRAL REGULATED POWER SUPPLY

The WJ-291 is a completely self-contained, miniaturized CW gas laser requiring only a 117 volt ac line-voltage wall outlet. The unit is adjustment-free in operation, except for intentional cavity tuning and discharge current variation, which is easily performed from the outside. Through a unique design of the plasma tube, low voltage operation of the dc-discharge is accomplished. This results in increased operating safety, high output stability and a large reduction in size of the integral power supply.

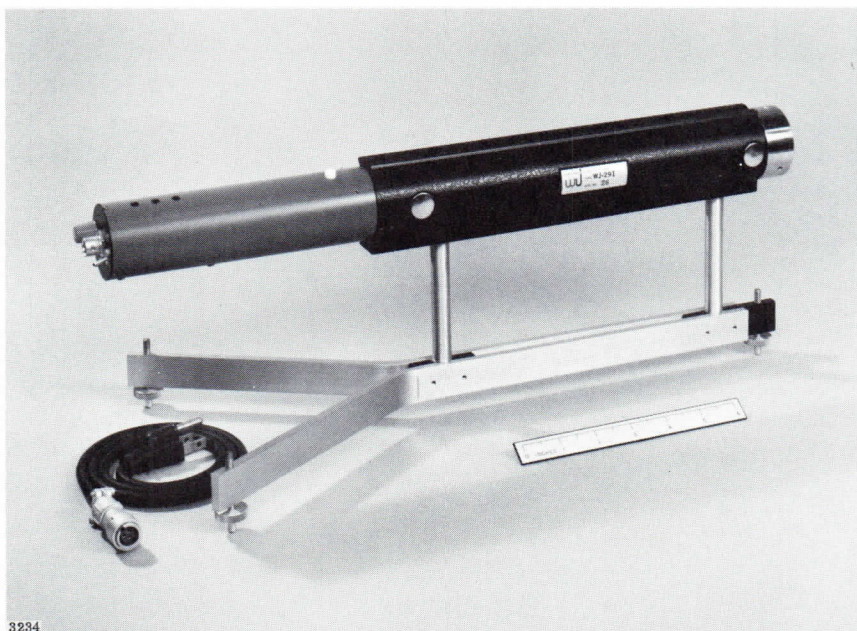

The WJ-291 is a dc-pumped helium-neon gas laser which provides a stable nominal output power of 2 milliwatts. This highly portable unit is normally supplied with confocal cavity resonators for operation at 6328 Å in the visible range. Easily interchangeable mirrors which are available as optional accessories permit conversion of each unit for operation in the uniphase hemispherical cavity configuration.

* This Technical Bulletin presents up-to-date information on the WJ-291, first described in Volume 6, No. 1, January 1964.

Like its predecessor, the WJ-283, the WJ-291 offers rugged coaxial construction and excellent mechanical precision. The use of a high-gain discharge tube permits an unusually compact design. The complete laser, including the integral 117-volt ac power supply, is as small and light as a medium sized flashlight, and a performance rating of one milliwatt CW light output per pound has been realized in this unit.

The ruggedized plasma tube features especially long-life heated cathodes, large gettering areas and gas reservoir as well as double-walled design. The techniques and procedures developed to achieve the outstanding reliability of Watkins-Johnson ultra-low-noise traveling-wave tubes and satellite communication tubes are also applied in the processing of the WJ-291 tube, to assure long laser life.

Due to its small size and low cost, the WJ-291 laser is ideally suited as an optical signal source for schools, to conduct demonstrations and experiments with monochromatic, coherent light. As a compact laboratory instrument or as an optical transmitter in the field, it will satisfy demands for a lightweight visible CW coherent light source.

Details of electrical and mechanical characteristics are given on the attached specification sheet.

With each unit, a laboratory manual is supplied which presents a selection of introductory as well as advanced experiments with monochromatic, coherent light. Although aimed primarily at high-school and college physics classes, these experiments also provide starting points for present day research in such diverse fields as communications, spectroscopy, atomic physics, high-energy electron physics, and even medical and biophysical research.

Accessories available on special order include collimators, spherical and plane mirror combinations for hemispherical operation, a laboratory stand, and a transistorized power supply for 12 v dc operation.

Any further inquiries may be addressed to our Applications Engineering or to our representative in your area.

WATKINS-JOHNSON COMPANY
Stanford Industrial Park
3333 Hillview Avenue
Palo Alto, California

Telephone: Area Code 415-326-8830
Teletype: Area Code 910-373-1253

1 May 1965

WJ-291

HELIUM-NEON DC-PUMPED GAS LASER WITH
INTEGRAL REGULATED POWER SUPPLY

PERFORMANCE

Laser wavelength	6328 Å
Output power (beam available from one end only)	2 milliwatts CW typical 1.5 milliwatts CW guaranteed

OPTICAL CHARACTERISTICS

Reflectors	Multilayer-dielectric coated mirrors, greater than 99 percent reflection on cavity side. Anti-reflection coating on output side. Confocal spherical mirrors, alignment by easily accessible precision screws.
Beam polarization	Plane polarized by effect of Brewster angle windows.
Beam diameter and divergence	0.080 inch maximum diameter at laser output. Maximum angular divergence 30 arc minutes confocal, 15 arc minutes hemispherical mirrors, when used with optional collimator, WJ-902-2. Beam is diffraction limited in hemispherical mode of operation.
Cavity parameters	10.5 inches spacing between reflectors, 2 mm plasma tube diameter. 0.007 plasma tube diameter to reflector spacing ratio.
Axial mode separation	560 Mc

ELECTRICAL REQUIREMENTS

	<u>Typical</u>	<u>Range</u>
Standard:		
Primary voltage	117 v ac	117 ± 5 v ac
Primary frequency	60 cps	48 to 400 cps
Primary power	25 w	
Optional:		
Primary voltage	12 v dc	12 ± 1 v dc
Primary power	20 w	

MECHANICAL CHARACTERISTICS

Laser length*	18 5 inches
Laser diameter*	1 75 inches
Weight*	2 pounds 6 ounces
Operating position	Any
Ruggedization and environment	Good commercial standards**

RF INTERFERENCE

No rf interference is created as no rf source used due to dc pumping.

ACCESSORIES AND MOUNTING

	Telescope mounting rib on top of laser body, mounting and alignment rib as well as thread for standard tripod mount on bottom, two threads for optical laser accessories on output end of laser body. (See Fig. 1)
WJ-902-2	Adjustable collimator, half inch nominal beam diameter.
WJ-905	Laboratory stand
WJ-903-3	Flat mirror for hemispherical mode operation at 6328 Å.
WJ-916	Transistorized power supply for 12 v dc operation.

* Including complete integral regulated power supply and starting circuit. Power supply offers quick disconnect plug-in, permitting easy access to rear mirror

** Units meeting MIL spec. shock and environmental conditions are available on special order.

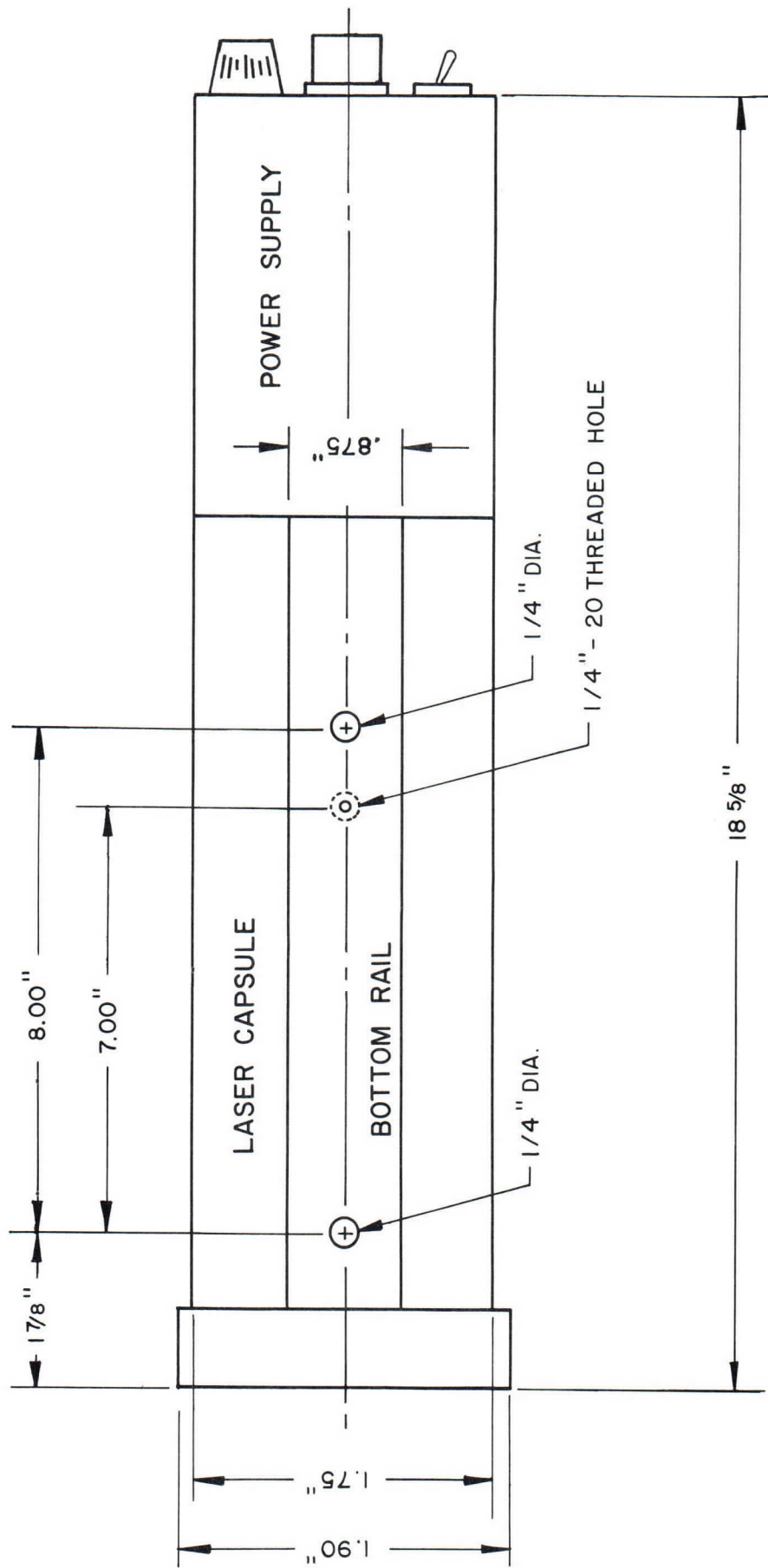

MOUNTING DIAGRAM FOR THE WJ-291 GAS LASER



Vol. 6, No. 8; September, 1964

WJ-316

HELIUM-NEON DC-PUMPED GAS LASER WITH TEMPERATURE STABLE, SINGLE AXIAL MODE OPERATION FEATURING AFC AND ELECTROMAGNETIC FREQUENCY SWEEP

The WJ-316 represents a compact, high precision stable-frequency oscillator, offering automatic frequency control, electromagnetic tuning, and swept-frequency operation. With hemispherical cavity configuration, a power output of 100 microwatts CW is guaranteed in the TEM_{00n} single-axial mode.

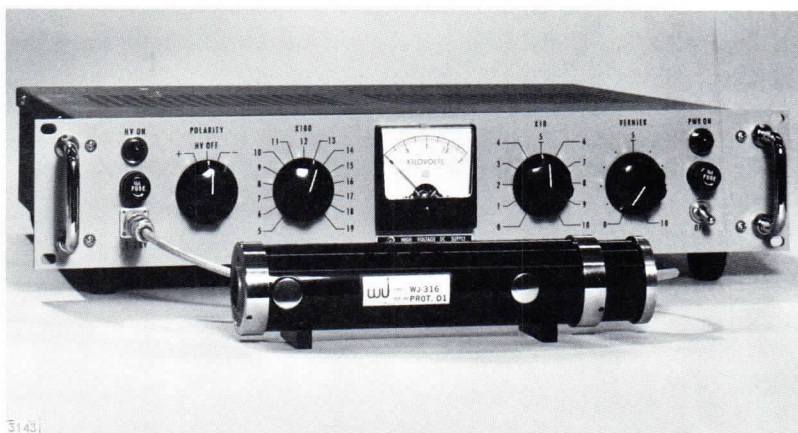

Corresponding to model numbers WJ-316, WJ-316-1 and WJ-316-2, are the three available frequency ranges centered on 6228\AA , 1.5μ and 3.39μ . Easily interchangeable mirrors, available as optional accessories, permit conversion of the WJ-316 for operation at any of these three wavelengths.

The WJ-316 maintains the basic cavity dimensions of the well proven WJ-283 which, for the first time in commercial gas lasers, offered a 1 Gc mode-spacing through realization of a reflector spacing of 150 mm. Like its predecessor, the WJ-316 not only guarantees single axial, single transverse mode operation, but also achieves the highest degree of frequency stability utilizing a unique temperature compensated cavity design. The exclusive electromagnetic cavity tuning module permits variation of the cavity length by up to fifteen wavelengths at audio frequency rates. Tuning sensitivity

is roughly 1 \AA per millivolt, with final resolution limited only by residual temperature effects and mechanical vibration.

The WJ-316 is designed in rugged, coaxial construction inside a heavy walled, precision machined invar capsule. Output is available from one end, the other end being occupied by the built-in photo-detector provided for monitoring and automatic frequency control purposes. The instrument employs a separately housed high quality power supply with a short term voltage stability of 5×10^{-3} per cent per hour.

The ruggedized plasma tube features heated cathodes, double-walled design and large gas reservoir, and incorporates the long term experience gained on the WJ-283 and WJ-291 tubes, resulting in exceptional tube life.

All optical components are selected for highest quality and precision and assure excellent spatial coherence of the spherical wave-fronts produced.

Details of electrical and mechanical characteristics are given on the attached specification sheet.

Collimating telescopes and various other electro-optical accessories are available.

Any further inquiries may be addressed to our Application Engineering Department, or to our representative in your area.

TENTATIVE SPECIFICATION

WJ-316

HELIUM-NEON DC-PUMPED GAS LASER WITH TEMPERATURE-COMPENSATED STABLE CAVITY, SINGLE AXIAL MODE OPERATION FEATURING AFC AND ELECTROMAGNETIC FREQUENCY SWEEP

PERFORMANCE

	<u>WJ-316</u>	<u>WJ-316-1</u>	<u>WJ-316-2</u>
Laser Wavelength	6328 Å	1.15μ	3.39μ

(Interchangeable mirrors are available permitting easy conversion of any model to operate it at any of the three wavelengths)

Output power (beam available from one end only)

All models
200 microwatts CW typical
100 microwatts CW guaranteed, in TEM_{00n}, single axial mode

OPTICAL CHARACTERISTICS

Reflectors

Multilayer-dielectric coated mirrors, greater than 99 percent reflection on cavity side. Anti-reflection coating on output side. One planar, one spherical (output) mirror, alignment by easily accessible precision screws.

Beam polarization

Plane polarized by effect of Brewster angle windows.

Beam diameter and divergence

0.065 inch maximum diameter at laser output. Maximum angular divergence 15 arc minutes, without collimation. Beam is diffraction limited and can be collimated to an angle.

$\alpha = \frac{\lambda}{A}$ where λ is the wavelength and A the effective aperture width.

Cavity parameters

150 mm spacing between reflectors, 1.4 mm plasma tube diameter. 0.35×10^{-3} plasma tube diameter to reflector spacing ratio.

Axial mode separation	1 Gc
Tuning Range Cavity	By electromagnetic tuning element. Total variation of cavity length 15 wavelengths, tuning voltage 1 millivolt per Å.
Oscillator (Single Axial Mode)	Limited by Doppler linewidth, single-pass gain and (axial) multimode effects. 6328 Å: ±250 Mc, full output power. ±500 Mc, reduced output power (detuned cavity or high transmission output mirror).
Short Term Stability	6328 Å: =100 Mc for ten seconds, without AFC. ±20 Mc, center frequency, per hour, with AFC (output swept at 60 cps, over ±200 Mc, sinusoidal sweep)
Sweep Waveform and Speed	Sinusoidal, 60 cps line internal, or 0 to 10 kc, external. Speed 0 to 30 Gc per half cycle, linear during corresponding portion of sinusoid.
AFC	Error signal derived from Doppler line envelope, through internal photo-detector monitor. Tuning signal derived from phase detector and fed back to tuning element through control amplifier.*
FM	Frequency deviation 500 Mc maximum, single axial mode operation. Modulation rate 0 to 10 kc.
AM	Through dc discharge current, 0 to 200 kc, 30 percent modulation depth.
Modes of Operation	AFC, sweep ±200 Mc at 60 cps AFC disabled, sweep at external rate and frequency deviation AFC disabled, electromagnetic tuning from external source, AM from external source.

* Available as an optional accessory

ELECTRICAL REQUIREMENTS

	<u>Typical</u>	<u>Range</u>
Primary voltage	117 v ac	117 v $\pm 10\%$
Primary frequency	60 cps	50 to 60 cps
Primary power	100 w	

MECHANICAL CHARACTERISTICS

Laser Length*	9 inches
Laser diameter*	2 inches
Laser weight*	3 pounds
Laser operating position	Any
Ruggedization and environment	Good commercial standards**
Power Supply	Size 3 1/2" x 19" panel, chassis 14" deep, 17" wide Weight 28 pounds

ACCESSORIES AND MOUNTING

Mounting ribs on capsule bottom, thread for optical laser accessories on output reflector assembly

RF INTERFERENCE

No rf interference is created as no rf source used due to dc pumping

* Including complete control and starting circuit.

** Units meeting MIL spec. shock and environmental conditions are available on special order.

WATKINS-JOHNSON COMPANY
Stanford Industrial Park
3333 Hillview Avenue
Palo Alto, California

Telephone: (415) 326-8830

15 September 1964

ULTRA LOW-NOISE TUBES

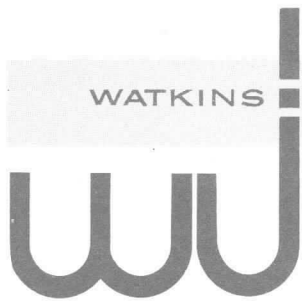

Vol. 2, No. 6; November, 1960

WJ-211, WJ-212 Family of
Ultra Low-Noise Traveling-Wave Amplifiers from 1.0 - 4.0 Gc

With the addition of the WJ-212 ultra low-noise traveling-wave amplifier, Watkins-Johnson Company offers two tubes covering the 1.0 to 4.0 Gc range, each with a guaranteed maximum noise figure less than 5.5 db. Optimization of the voltages and input impedance matching of these tubes allows the specification of even lower noise figures over narrower frequency ranges as described below:

<u>Model Number</u>	<u>Frequency Gc</u>	<u>Nominal Terminal Noise Figure (db)</u>	<u>Maximum Terminal Noise Figure (db)</u>
WJ-211	2.0-4.0	4.3	5.5
WJ-211-1	2.1-2.4	3.5	4.0
WJ-211-2	2.3-2.7	3.4	4.0
WJ-211-3	2.5-3.5	3.9	4.5
WJ-212	1.0-2.0	4.0	5.0
WJ-212-1	1.1-1.6	3.6	4.5

These tubes are externally identical and require similar voltages. They provide the singular advantage of interchangeability of solenoids and power supplies for all models. All models utilize only four voltages on multiple-connected anodes. They incorporate the extreme low-noise capability of the multiple anode structure with the simplicity of fewer operating voltages. See Fig. 1 for outline drawings.

Further optimization of the noise figure of these tubes can be obtained at frequencies ranging from 800 to 4500 Mc. Electrical requirements as shown have been derived from initial test results and should be used as criteria for planning purposes only. Any further inquiries may be addressed to Applications Engineering or to our representative in your area.

TENTATIVE SPECIFICATION

WJ-211, 2-4 Gc Ultra Low-Noise Traveling-Wave Amplifier

PERFORMANCE

	<u>Typical</u>	<u>Guaranteed</u>
Frequency	2.0-4.0 Gc	2.0-4.0 Gc
Noise figure, terminal	4.3 db	5.5 db, max.
Gain, small signal	25 db	20 db, min.
VSWR, input and output	1.5:1	2:1, max.

ELECTRICAL REQUIREMENTS*

	<u>Typical</u>	<u>Range</u>
Filament voltage	3.0 v	2-6 v
Filament current	0.6 a	0.4-0.9 a
Collector voltage	700 v	650-750 v
Helix voltage	175 v	165-185 v
Anode voltage, No. 1	3 v	0-5 v
Anode voltage, No. 2	1.8 v	0-5 v
Anode voltage, No. 3	10 v	5-20 v
Anode voltage, No. 4	65 v	40-120 v
Beam current	40 μ a	30-60 μ a
Helix and anode currents	< 0.1 μ a	0-1 μ a
WJ-SL1 solenoid current	7.0 a	6.0-7.0 a
WJ-SL1 solenoid voltage	80 v	70-90 v

* All tube voltages are measured with respect to cathode

MECHANICAL

Capsule diameter	1 3/8 inches
Capsule length (excluding connectors)	16 3/4 inches
Weight	2 pounds
DC connections	Winchester M-12P
RF connections	Type N, female

WATKINS-JOHNSON COMPANY
Stanford Industrial Park
3333 Hillview Avenue

Telephone: Davenport 6-8830

27 July 1962

(Revision of 1 December 1961 revision)

TENTATIVE SPECIFICATION

WJ-211-1, 2.1-2.4 Gc Ultra Low-Noise Traveling-Wave Amplifier

PERFORMANCE

	<u>Typical</u>	<u>Guaranteed</u>
Frequency	2.1-2.4 Gc	2.1-2.4 Gc
Terminal noise figure	3.5 db	4.0 db, max.
Gain, small signal	25 db	20 db, min.
VSWR, input and output	1.5:1	2:1, max.

ELECTRICAL REQUIREMENTS*

	<u>Typical</u>	<u>Range</u>
Filament voltage	3.0 v	2-6 v
Filament current	0.6 a	0.4-0.9 a
Collector voltage	700 v	650-750 v
Helix voltage	175 v	165-185 v
Anode voltage, No. 1	3 v	0-5 v
Anode voltage, No. 2	1.8 v	0-5 v
Anode voltage, No. 3	10 v	5-20 v
Anode voltage, No. 4	65 v	40-120 v
Beam current	40 μ a	30-60 μ a
Helix and anode currents	$< 0.1 \mu$ a	0-1 μ a
WJ-SL1 solenoid current	7.0 a	6.0-7.0 a
WJ-SL1 solenoid voltage	80 v	70-90 v

* All tube voltages are measured with respect to cathode

MECHANICAL

Capsule diameter	1 3/8 inches
Capsule length (excluding connectors)	16 3/4 inches
Weight	2 pounds
DC connections	Winchester M-12P
RF connections	Type N, female

WATKINS-JOHNSON COMPANY
Stanford Industrial Park
3333 Hillview Avenue
Palo Alto, California

Telephone: Davenport 6-8830

27 July 1962
(Revision of 1 December 1961 revision)

TENTATIVE SPECIFICATION

WJ-211-2, 2.3-2.7 Gc Ultra Low-Noise Traveling-Wave Amplifier

PERFORMANCE

	<u>Typical</u>	<u>Guaranteed</u>
Frequency	2.3-2.7 Gc	2.3-2.7 Gc
Terminal noise figure	3.4 db	4.0 db, max.
Gain, small signal	25 db	20 db, min.
VSWR, input and output	1.5:1	2:1, max.

ELECTRICAL REQUIREMENTS*

	<u>Typical</u>	<u>Range</u>
Filament voltage	3.0 v	2-6 v
Filament current	0.6 a	0.4-0.9 a
Collector voltage	700 v	650-750 v
Helix voltage	175 v	165-185 v
Anode voltage, No. 1	3 v	0-5 v
Anode voltage, No. 2	1.8 v	0-5 v
Anode voltage, No. 3	10 v	5-20 v
Anode voltage, No. 4	65 v	40-120 v
Beam current	40 μ a	30-60 μ a
Helix and anode currents	< 0.1 μ a	0-1 μ a
WJ-SL1 solenoid current	7.0 a	6.0-7.0 a
WJ-SL1 solenoid voltage	80 v	70-90 v

* All tube voltages are measured with respect to cathode

MECHANICAL

Capsule diameter	1 3/8 inches
Capsule length (excluding connectors)	16 3/4 inches
Weight	2 pounds
DC connections	Winchester M-12P
RF connections	Type N, female

WATKINS-JOHNSON COMPANY

Stanford Industrial Park

3333 Hillview Avenue

Palo Alto, California

Telephone: Davenport 6-8830

27 July 1962

(Revision of 1 December 1961 revision)

TENTATIVE SPECIFICATION

WJ-211-3, 2.5-3.5 Gc Ultra Low-Noise Traveling-Wave Amplifier

PERFORMANCE

	<u>Typical</u>	<u>Guaranteed</u>
Frequency	2.5-3.5 Gc	2.5-3.5 Gc
Terminal noise figure	3.9 db	4.5 db, max.
Gain, small signal	25 db	20 db, min.
VSWR, input and output	1.5:1	2:1, max.

ELECTRICAL REQUIREMENTS*

	<u>Typical</u>	<u>Range</u>
Filament voltage	3.0 v	2-6 v
Filament current	0.6 a	0.4-0.9 a
Collector voltage	700 v	650-750 v
Helix voltage	175 v	165-185 v
Anode voltage, No. 1	3 v	0-5 v
Anode voltage, No. 2	1.8 v	0-5 v
Anode voltage, No. 3	10 v	5-20 v
Anode voltage, No. 4	65 v	40-120 v
Beam current	40 μ a	30-60 μ a
Helix and anode currents	< 0.1 μ a	0-1 μ a
WJ-SL1 solenoid current	7.0 a	6.0-7.0 a
WJ-SL1 solenoid voltage	80 v	70-90 v

* All tube voltages are measured with respect to cathode

MECHANICAL

Capsule diameter	1 3/8 inches
Capsule length (excluding connectors)	16 3/4 inches
Weight	2 pounds
DC connections	Winchester M-12P
RF connections	Type N, female

WATKINS-JOHNSON COMPANY
Stanford Industrial Park
3333 Hillview Avenue
Palo Alto, California

Telephone: Davenport 6-8830

27 July 1962

(Revision of 1 December 1961 revision)

TENTATIVE SPECIFICATION

WJ-212, 1-2 Gc Ultra Low-Noise Traveling-Wave Amplifier

PERFORMANCE

	<u>Typical</u>	<u>Guaranteed</u>
Frequency	1.0-2.0 Gc	1.0-2.0 Gc
Terminal noise figure	4.0 db	5.0 db, max.
Gain, small signal	25 db	20 db, min.
VSWR, input and output, max.	1.5:1	2:1, max.

ELECTRICAL REQUIREMENTS*

	<u>Typical</u>	<u>Range</u>
Filament voltage	3.0 v	2-6 v
Filament current	0.6 a	0.4-0.9 a
Collector voltage	700 v	650-750 v
Helix voltage	85 v	70-155 v
Anode voltage, No. 1	3.0 v	0-5 v
Anode voltage, No. 2	2.5 v	0-5 v
Anode voltage, No. 3	8 v	0-25 v
Anode voltage, No. 4	10 v	5-80 v
Beam current	65 μ a	40-100 μ a
Helix and anode current	< 0.1 μ a	0-1 μ a
WJ-SL1 solenoid current	7.0 a	6.0-7.0 a
WJ-SL1 solenoid voltage	80 v	70-90 v

* All tube voltages are measured with respect to cathode

MECHANICAL

Capsule diameter	1 3/8 inches
Capsule length (excluding connectors)	16 3/4 inches
Weight	2 pounds
DC connections	Winchester M-12P
RF connections	Type N, female

WATKINS-JOHNSON COMPANY
Stanford Industrial Park
3333 Hillview Avenue
Palo Alto, California

Telephone: Davenport 6-8830

27 July 1962
(Revision of 1 December 1961 revision)

TENTATIVE SPECIFICATION

WJ-212-1, 1.1-1.6 Gc Ultra Low-Noise Traveling-Wave Amplifier

PERFORMANCE

	<u>Typical</u>	<u>Guaranteed</u>
Frequency	1.1-1.6 Gc	1.1-1.6 Gc
Terminal noise figure	3.6 db	4.5 db, max.
Gain, small signal	25 db	20 db, min.
VSWR, input and output	1.5:1	2:1, max.

ELECTRICAL REQUIREMENTS*

	<u>Typical</u>	<u>Range</u>
Filament voltage	3.0 v	2-6 v
Filament current	0.6 a	0.4-0.9 a
Collector voltage	700 v	650-750 v
Helix voltage	85 v	70-155 v
Anode voltage, No. 1	3.0 v	0-5 v
Anode voltage, No. 2	2.5 v	0-5 v
Anode voltage, No. 3	8 v	0-25 v
Anode voltage, No. 4	10 v	5-80 v
Beam current	65 μ a	40-100 μ a
Helix and anode currents	< 0.1 μ a	0-1 μ a
WJ-SL1 solenoid current	7.0 a	6.0-7.0 a
WJ-SL1 solenoid voltage	80 v	70-90 v

* All tube voltages are measured with respect to cathode

MECHANICAL

Capsule diameter	1 3/8 inches
Capsule length (excluding connectors)	16 3/4 inches
Weight	2 pounds
DC connections	Winchester M-12P
RF connections	Type N, female

WATKINS-JOHNSON COMPANY
Stanford Industrial Park
3333 Hillview Avenue
Palo Alto, California

Telephone: DAVenport 6-8830

27 July 1962

(Revision of 1 December 1961 revision)

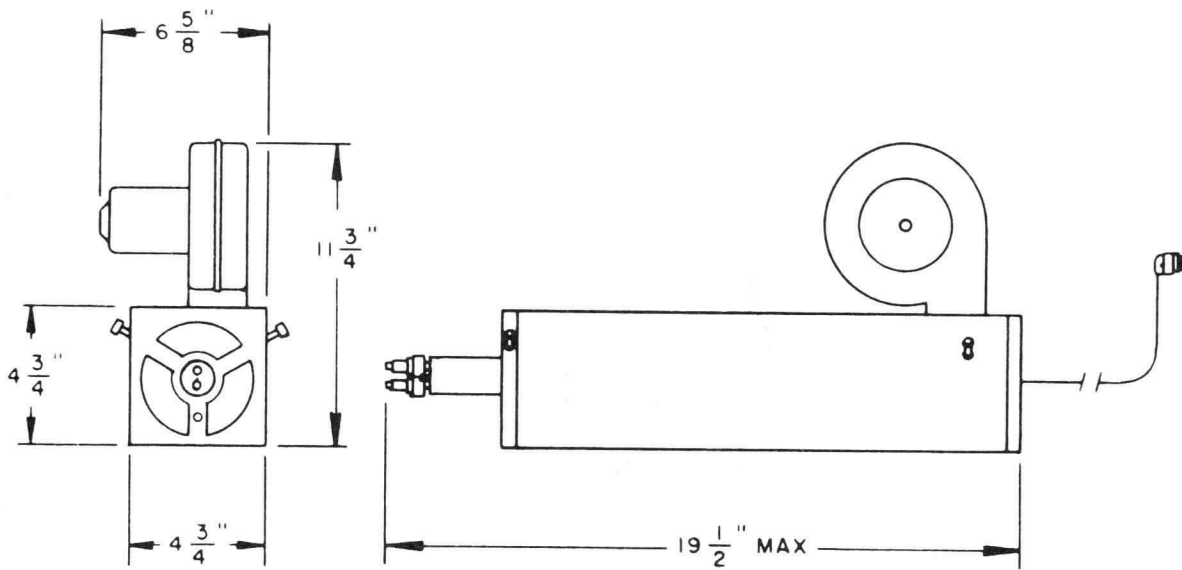
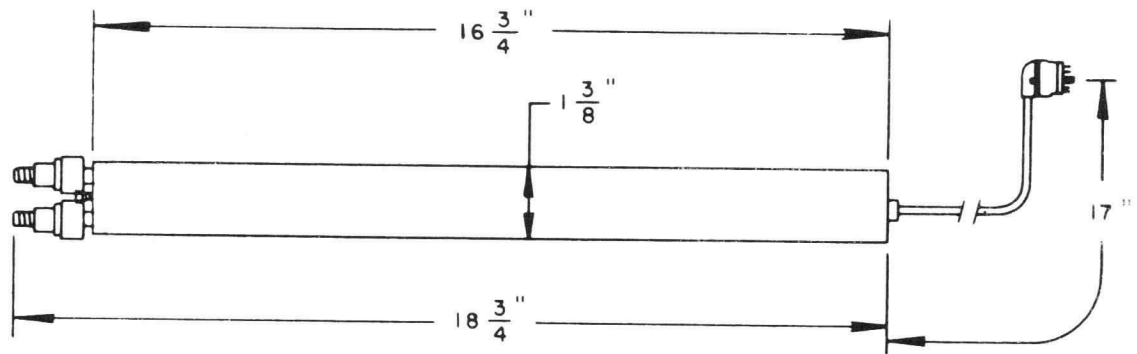

FIG. 1-OUTLINE DRAWINGS OF THE WJ-211, WJ-211-1, WJ-211-2, WJ-211-3, WJ-212, AND WJ-212-1 TUBES AND OF THE WJ-SLI SOLENOID. ALL TUBES ARE EXTERNALLY IDENTICAL AND USE THE SAME SOLENOID.



Vol. 3, No. 7; July 1961

WJ-221

250-500 Mc Ultra Low-Noise Traveling-Wave Amplifier

This low-noise traveling-wave amplifier covers the frequency range 250-500 Mc/s with noise figures below 5.0 db over the entire band with fixed voltages. It finds wide application in low-noise radar, telemetry, communications systems where high performance and reliability are required.

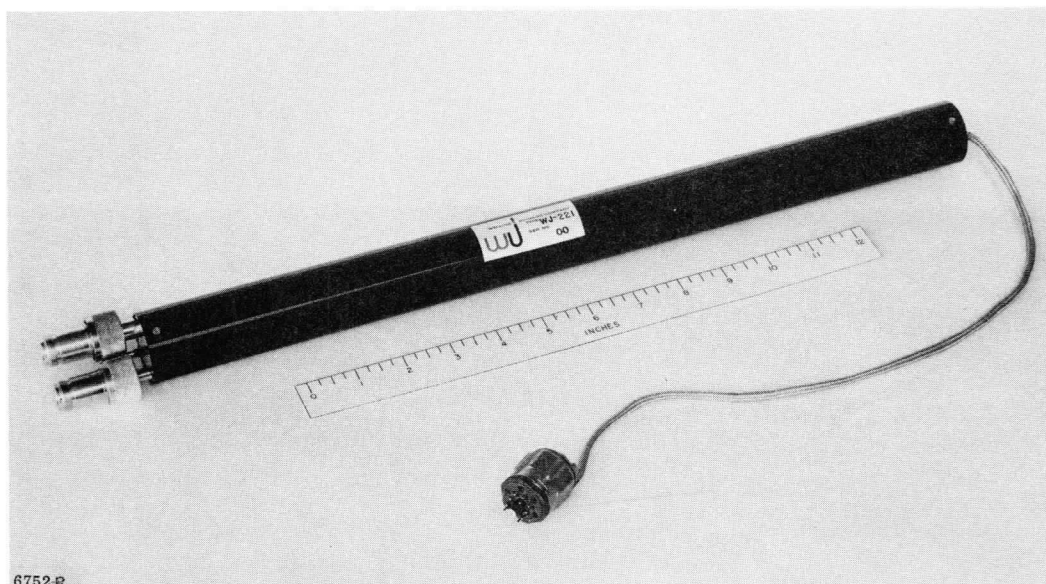

This tube is mechanically interchangeable with and utilizes the same solenoid as the L- and S-band members of the low-noise traveling-wave tube family, the WJ-212 and WJ-211. The WJ-221 design features very low circuit voltage. A special low temperature cathode, as well as extreme vacuum processing, are features which result in long operating life.

A glazed rod-supported helix enhances the ruggedness of this tube and permits operation in any orientation.

Any further inquiries may be addressed to our Applications Engineering or to our representative in your area.

TENTATIVE SPECIFICATION

WJ-221, 250-500 Mc Ultra Low-Noise Traveling-Wave Amplifier

PERFORMANCE

	<u>Typical</u>	<u>Guaranteed</u>
Frequency	200-600 Mc	250-500 Mc
Terminal noise figure	See Fig. 1	5.5 db, max.
Gain, small signal	28 db	20 db, min.
VSWR, input and output	1.8:1	2.0:1, max.

ELECTRICAL REQUIREMENTS*

Filament voltage	6.9 v	5.0-8.0 v
Filament current	0.65 a	0.6-0.8 a
Collector voltage	700 v	500-800 v
Helix voltage	50 v	45-55 v
Anode voltage, No. 1	3 v	0-10 v
Anode voltage, No. 2	1 v	0-5 v
Anode voltage, No. 3	10 v	0-30 v
Anode voltage, No. 4	30 v	0-50 v
Beam current	0.3 ma	0.2-0.5 ma
Helix and anode currents	0.1 μ a	0-1 μ a
WJ-SL2 Solenoid current	6.5 a	5.0-7.0 a
WJ-SL2 Solenoid voltage	90 v	60-100 v

* All tube voltages are measured with respect to cathode

MECHANICAL

Capsule diameter	1 3/8 inches
Capsule length (excluding connectors)	18 inches
Weight	2 pounds
DC connections	Winchester M-12P
RF connections	Type N, female

WATKINS-JOHNSON COMPANY
Stanford Industrial Park
3333 Hillview Avenue
Palo Alto, California

Telephone: Davenport 6-8830

2 January 1962
(Revision of 1 July 1961 original)

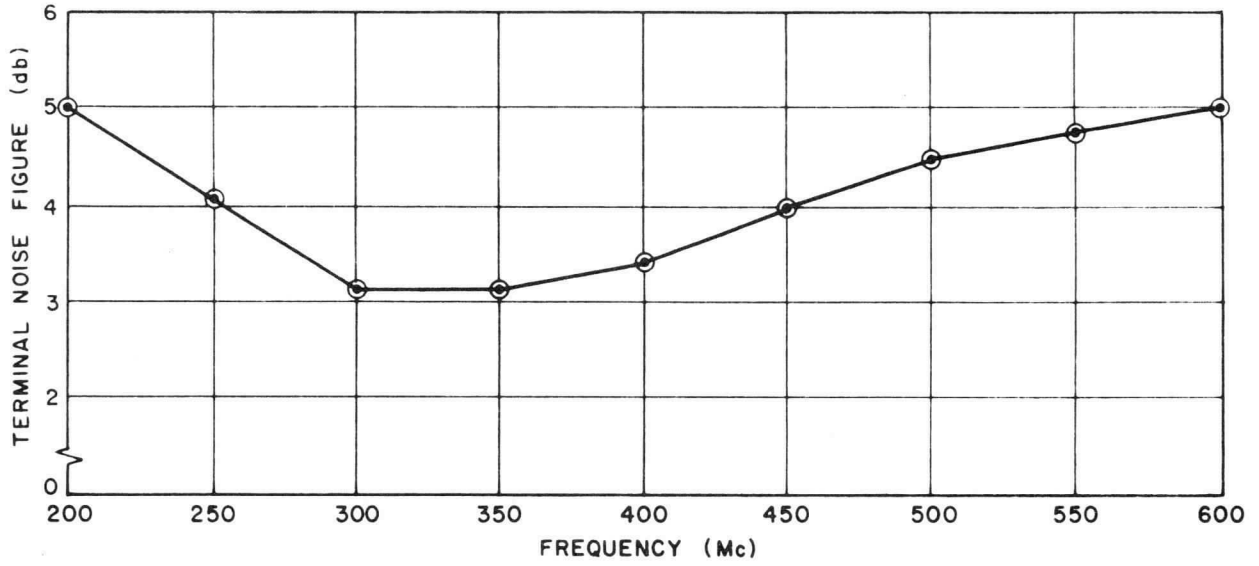

FIG.1-TYPICAL PERFORMANCE OF THE WJ-221

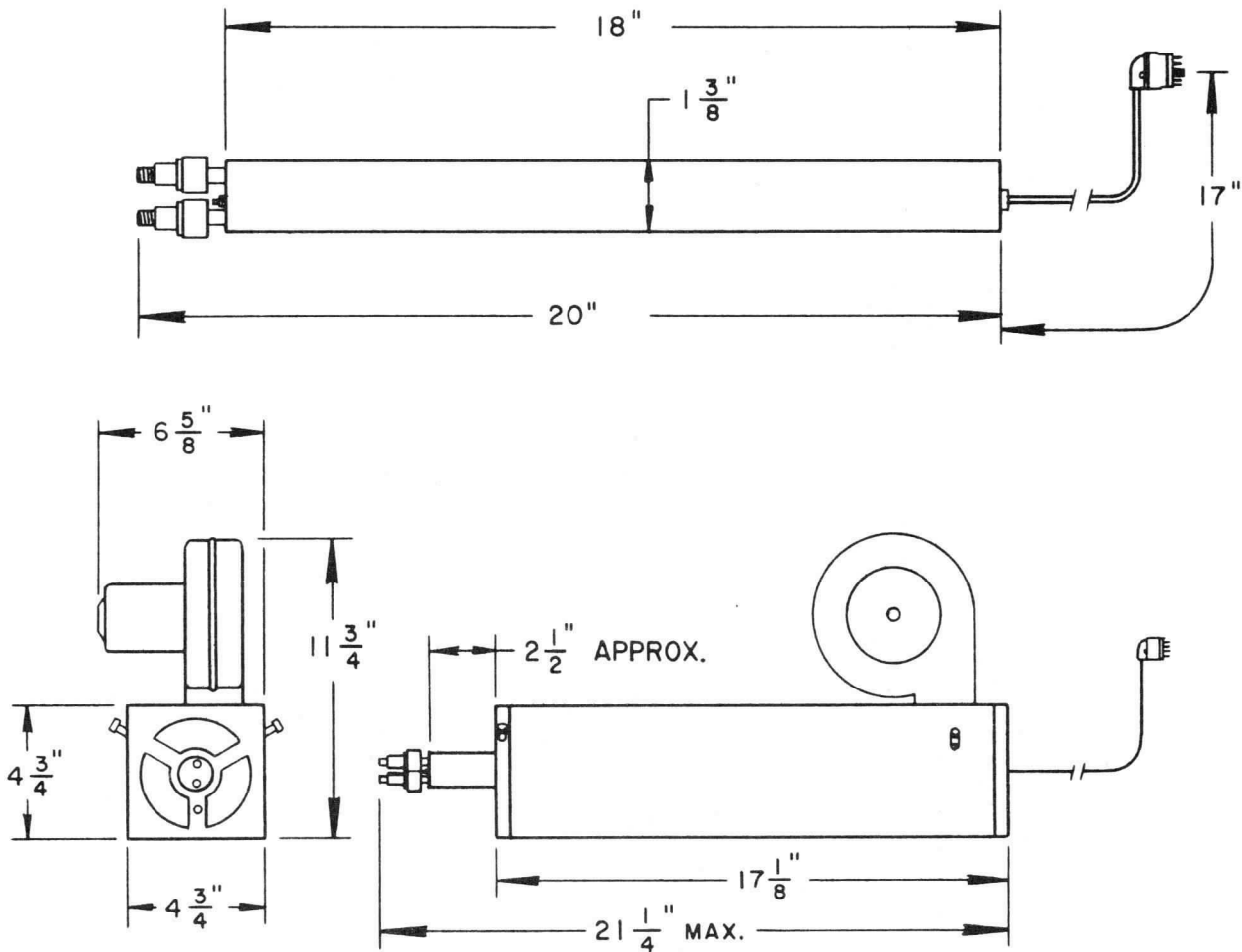

FIG.2-OUTLINE DRAWINGS OF THE WJ-221 AND WJ-SL2 SOLENOID



Volume 5, No. 8 ; August 1963

WJ-257

K_u-BAND LOW-NOISE TRAVELING-WAVE AMPLIFIER

This low-noise traveling-wave amplifier covers the frequency range 12-18 Gc with noise figures below 10.0 db over the entire band with fixed voltages. It finds wide application in radar, telemetry, communications, and reconnaissance systems where high performance and reliability are required.

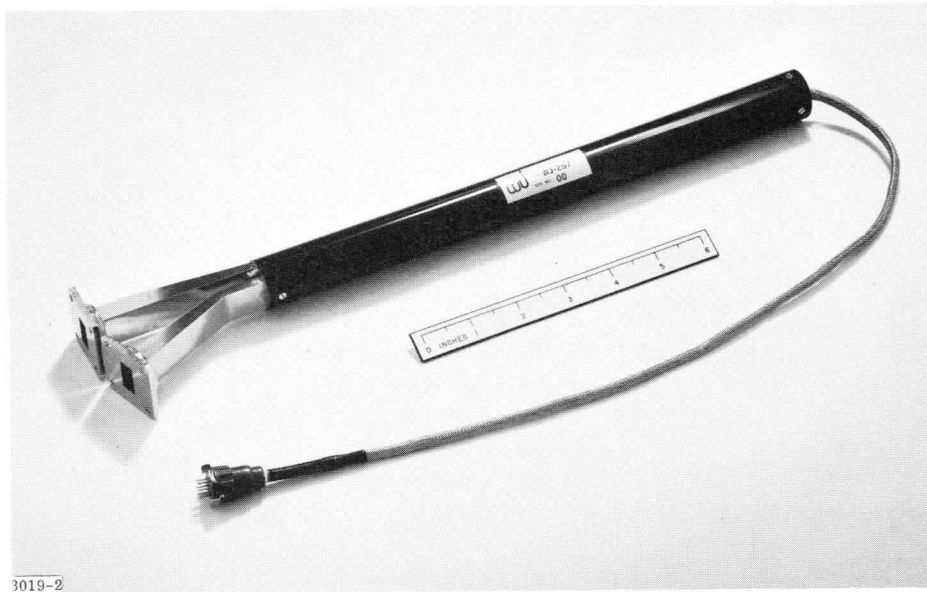

The WJ-257 is mechanically rugged and can be operated in any orientation. Features of its design include a relatively low helix voltage and low cathode loading. The latter, coupled with stringent vacuum processing, contributes to long life and reliability.

Operating voltages are normally set to optimize noise performance over the full band. For narrow band operation, noise figure improvement of up to 1.5 db can be obtained by voltage tuning.

A special solid-state power supply designed at Watkins-Johnson to operate the WJ-257 is available, as are complete amplifier packages for rack or antenna mounting.

Any further inquiries may be addressed to our representative in your area, or to Applications Engineering at our Palo Alto facility.

TENTATIVE SPECIFICATION

WJ-257

K_u-BAND LOW-NOISE TRAVELING-WAVE AMPLIFIER

<u>PERFORMANCE</u>	<u>Typical</u>	<u>Guaranteed</u>
Frequency	12-18 Gc	12-18 Gc
Terminal noise figure	8 db	10 db, max.
Gain, small signal	28 db	25 db, min.
VSWR, input and output	1.5	2.0, max.
Power output	3 dbm	

<u>ELECTRICAL REQUIREMENTS*</u>	<u>Typical</u>	<u>Range</u>
Filament voltage	4.0 v	3.0-4.5 v
Filament current	0.70 a	0.60-0.75 a
Collector voltage	1500 v	1200-2000 v
Helix voltage	760 v	700-850 v
Anode voltage, No. 1	5 v	0-15 v
Anode voltage, No. 2	20 v	0-50 v
Anode voltage, No. 3	60 v	0-200 v
Anode voltage, No. 4	70 v	0-200 v
Anode voltage, No. 5	600 v	500-900 v
Beam current	300 μ a	200-400 μ a
Helix and anode currents	1 μ a	0-10 μ a
WJ-SL4 Solenoid current	10 a	9-10.5 a
WJ-SL4 Solenoid voltage	45 v	40-50 v

* All tube voltages are measured with respect to cathode.

MECHANICAL

Capsule diameter	1 inch
Capsule length (excluding connectors)	12 inches
Weight	1.25 pounds
DC connections	Winchester M-12P
RF connections	UG419/U waveguide flange

WATKINS-JOHNSON COMPANY
Stanford Industrial Park
3333 Hillview Avenue
Palo Alto, California

Telephone: Area Code 415
326-8830

1 August 1963



Vol. 6, No. 6; April, 1964*

THE WJ-227-5

A 12-WATT CW TRAVELING-WAVE TUBE

This technical bulletin describes a high efficiency, reliable traveling-wave tube designed and produced specifically for the pre-launch, the launch, and space environment phases of earth and lunar orbiting satellites. The tube possesses proven reliability and has been fully flight qualified by three independent sources. Further, the tube is presently the only one in its frequency range and power level that has successfully operated as specified during actual orbiting of the earth.

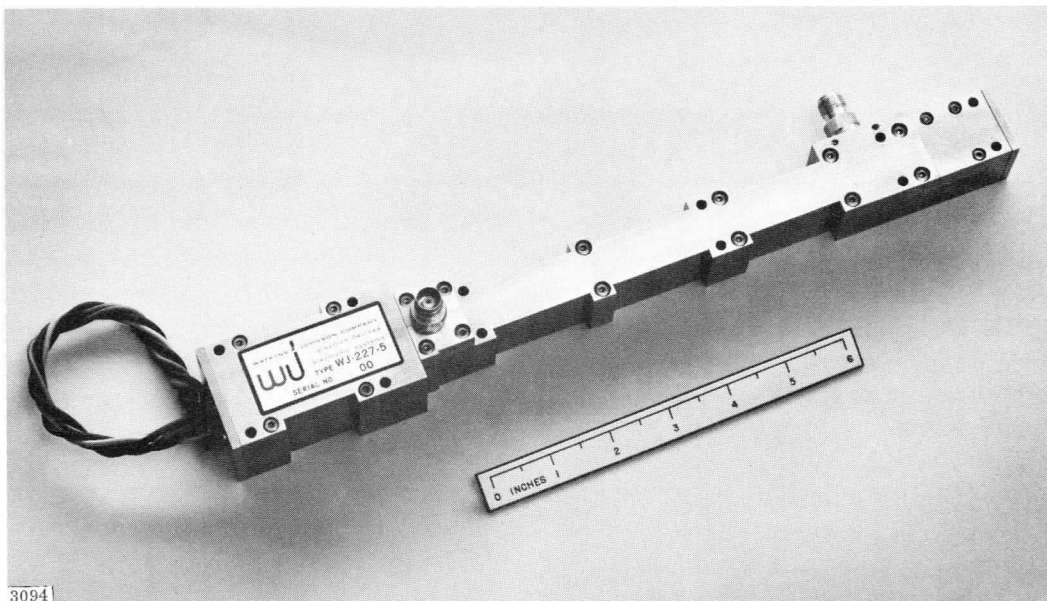

The attached specification describes the tube in detail. The design approach is extremely conservative in that it has been based on low cathode loading (80 ma/cm^2) with concomitant life exceeding 30,000 hours. Additional reliability is assured by greater than 99 percent beam transmission to the collector under conditions where the guaranteed overall efficiency exceeds 25 percent. Further design features that assure the maximum in reliable, long-life operation under the environment of vehicle boost and re-entry, follow.

*This Technical Bulletin presents up-to-date information on the WJ-227, first described in Volume 3, No. 5; July, 1961.

The tube incorporates an extremely rugged electron gun assembly wherein the anode, cathode and other parts are securely joined together in a rigid assembly and then mounted to eliminate any relative motion among gun, helix, envelope and magnet. This method results in precise tolerances easily maintained throughout the life of the tube, even though it experiences the most difficult operating environments. Mechanical ruggedness is accomplished by securely glazing each turn of the helix to three ceramic support members, thereby eliminating any turn-to-turn motion of the helix. In addition, the vacuum envelope is shrunk-locked onto the helix rods. Additional strength is achieved by encapsulating the entire tube within the magnetic structure and capsule, thereby greatly reducing the possibility of physical damage to the device under conditions of shock and vibration. Due to the low cathode current density, low cathode operating temperature, proper ion control, and high-temperature processing, long life and high reliability are assured. Recent accelerated life tests on an eight tube sample have accumulated over 80,000 test hours and indicate that the mean-time-to-failure for the WJ-227-5 is in excess of 30,000 hours.

Any further inquiries may be addressed to our Application Engineering or to our representative in your area.

TENTATIVE SPECIFICATION

THE WJ-227-5

A 12-WATT CW TRAVELING-WAVE TUBE

<u>PERFORMANCE</u>	<u>Typical</u>	<u>Guaranteed</u>
Frequency	2.0-2.4 Gc	2.0-2.4 Gc
Power output	13 w	12 w min.
Gain at saturation	35 db	33 db min.
Over-all efficiency (including heater power)	28 percent	25 percent min.
Noise figure	30 db	35 db max.
<u>ELECTRICAL REQUIREMENTS</u>	<u>Typical</u>	<u>Range</u>
Helix voltage ¹	1600 v	1550-1650 v
Helix current (under saturated power output and depressed collector conditions)	0.5 ma	0-2.0 ma
Anode voltage ¹	1700 v	1600-1800 v
Anode current	5 μ a	0-500 μ a
Collector voltage ^{1, 2}	1000 v	900-1100 v
Collector current (under saturated power output and depressed collector conditions)	44.5 ma	37-47 ma
Cathode current	45 ma	37-47 ma
Heater voltage ³	5.0 v	4.5-5.5 v
Heater current	0.80 a	0.75-1.00 a
Focusing	Periodic Permanent Magnet	
<u>MECHANICAL CHARACTERISTICS</u>		
Capsule dimensions	1.715 x 1.42 x 13.275 inches max.	
Weight	39 ounces, max.	
Connectors, dc	Flying leads	
Connectors, rf	TNC, Greomar No. 7437A	
Cooling	Conduction cooling through the flat bottom surface of the capsule to a heat sink	

ENVIRONMENTAL REQUIREMENTS

Operating temperature range	-30°F to +165°F
Pressure	Nominal one atmosphere (sea level) to 10 ⁻⁷ mm of mercury
Vibration	
a) Sinusoidal constant octave, 45 min. sweep	5-14 cps 1/4" peak 14-400 cps 5 g 400-3000 cps 10 g
b) Random	.05 g ² /cps, 15-2000 cps spectral density for 5 minutes in each axis
Shock	Approximately half sine, 40 g, 6 milliseconds duration. Three shocks in both directions, along three axes - total 18 shocks
Acceleration	12 g for 10 minutes - 3 axes

1. All voltages measured with respect to cathode
2. Collector is operated at ground potential and all other voltages are floating above or below ground potential
3. For long-life operation, heater voltage should be regulated to the range indicated

WATKINS-JOHNSON COMPANY
Stanford Industrial Park
3333 Hillview Avenue
Palo Alto, California

Telephone: (415) 326-8830
Teletype: (910) 373-1253

1 April 1964

TYPICAL PERFORMANCE OF THE WJ-227-5 HIGH EFFICIENCY TRAVELING-WAVE TUBE AMPLIFIER

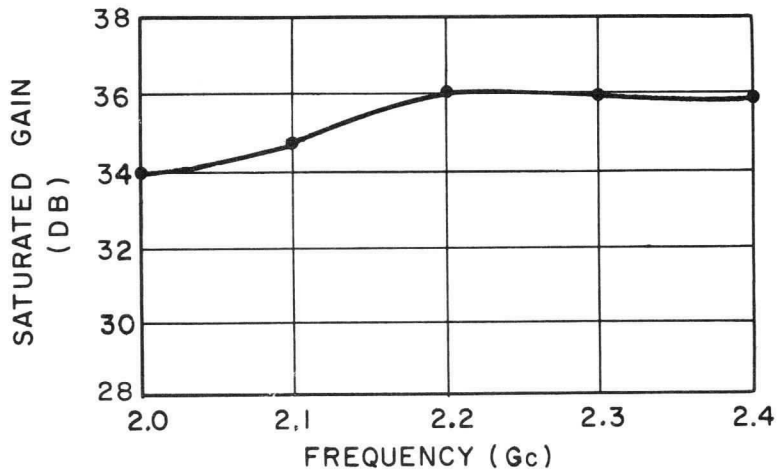
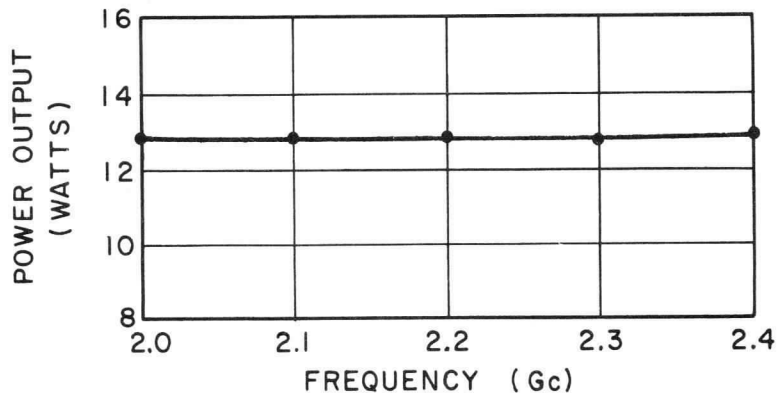
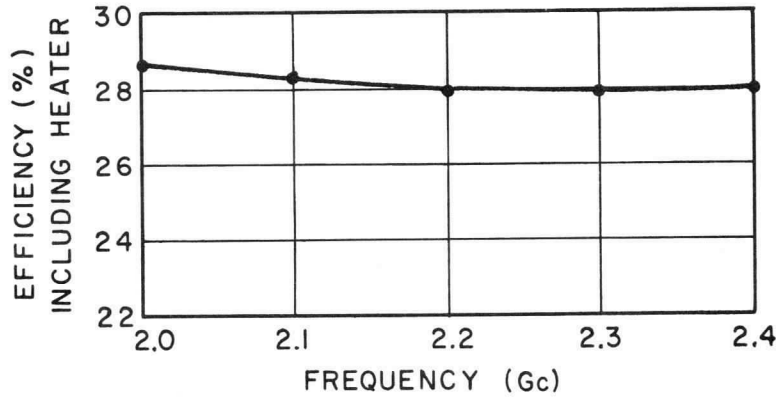

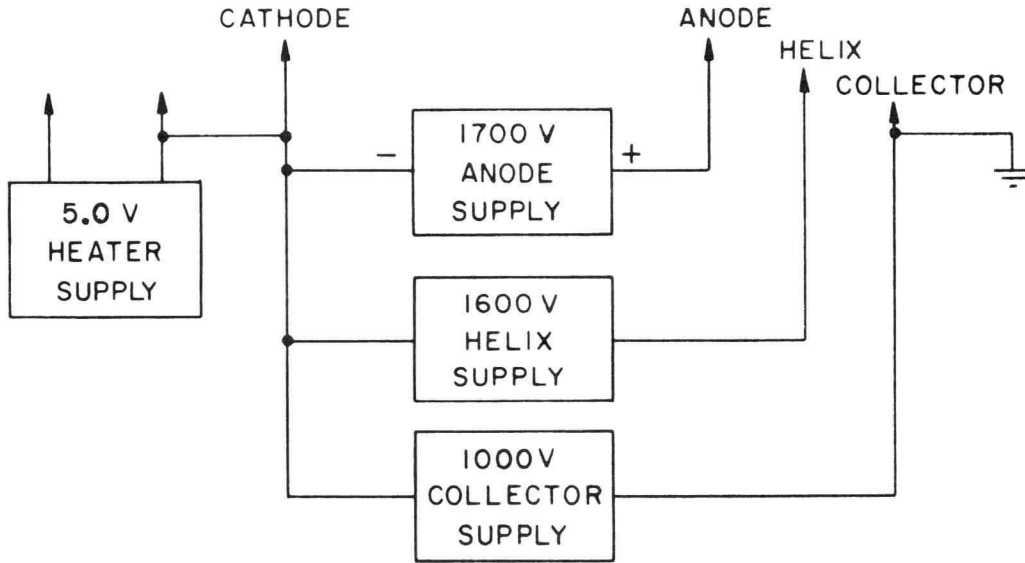

BLOCK DIAGRAM OF TYPICAL POWER SUPPLY FOR WJ-227-5
HIGH EFFICIENCY TRAVELING-WAVE TUBE AMPLIFIER

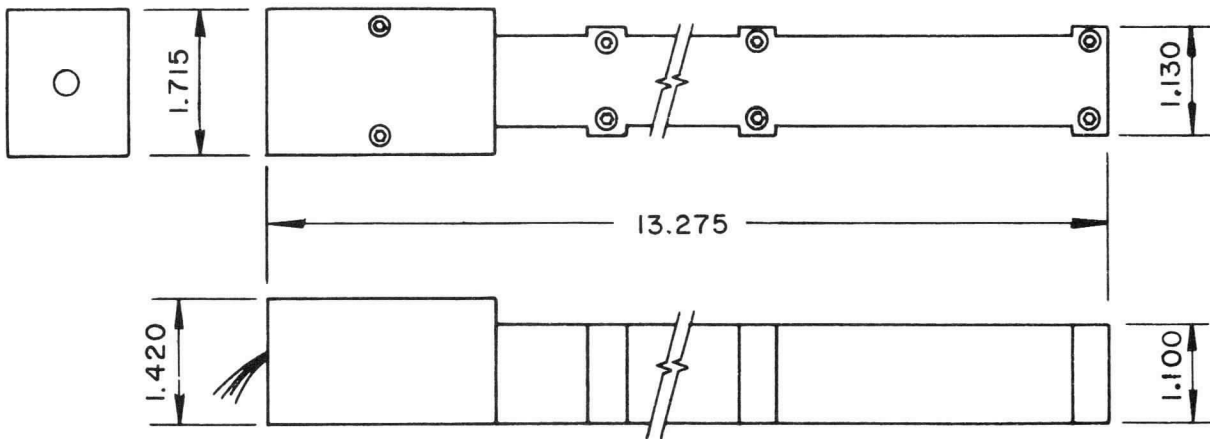

OUTLINE DRAWING OF WJ-227-5 HIGH EFFICIENCY
TRAVELING-WAVE TUBE AMPLIFIER



Vol. 8, No. 11; July, 1966

WJ-231-5

5.0 TO 8.5 GHz, 35 WATT CW PPM-FOCUSED
TRAVELING-WAVE TUBE

Watkins-Johnson WJ-231-5 is a versatile, wideband traveling-wave tube employing periodic-permanent-magnet focusing. Providing a guaranteed CW power output of 35 watts from 5.0 to 8.5 GHz, the WJ-231-5 is the basic tube used in the WJ-1015 satellite amplifier and the WJ-364 commercial amplifier. A separate power supply, the WJ-1024, is also available for operating the WJ-231-5. This power supply is available in versions for laboratory or military environments.

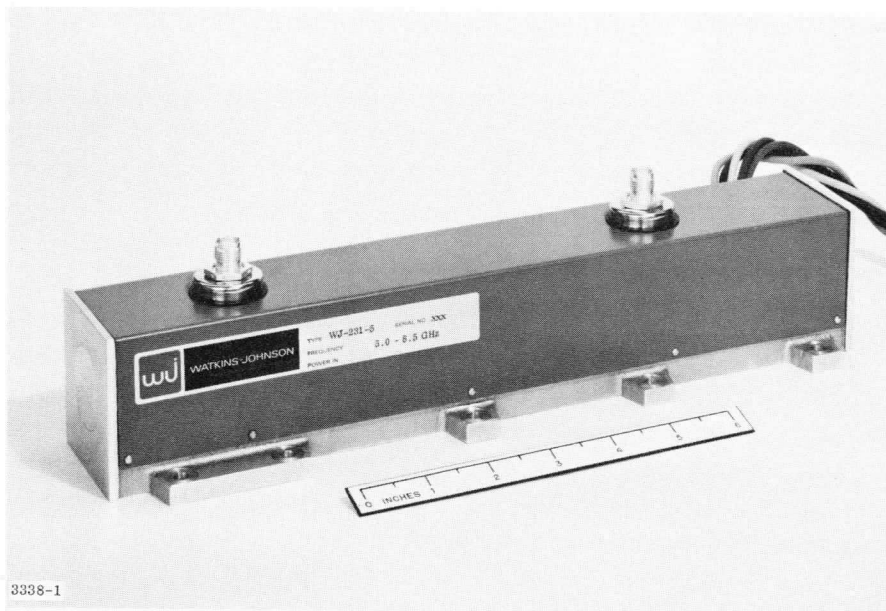

This TWT represents the end product of a series of developmental and production units fabricated for a high-reliability space program. Its design employs many of the techniques and components proven successful in earlier models of Watkins-Johnson medium-power traveling-wave tubes, e.g., stacked metal-ceramic electron-gun assembly, precision-aligned PPM focusing components, and beryllia wedge-supported helix structure.

The electron gun is a two-section assembly which has proven to be rugged, highly reliable, and accurately reproducible. The first section of the assembly is composed of ceramic insulators, metal connection discs, and anode and focusing electrode. These parts are precision aligned and brazed together on special equipment at Watkins-Johnson. The second section of the electron gun assembly consists of cathode, cathode support, and heater. The two sections are connected by inserting the cathode section into the focusing electrode, positioning being accomplished by a precision alignment process.

The focusing structure consists of a series of magnetic pole pieces separated by non-magnetic spacers, brazed to a non-magnetic section of tubing that serves as an alignment mandrel for the pole pieces and as a vacuum wall. Inside and outside dimensions of this tubing are held to very close tolerances to insure a precision fit between helix structure and body, and accurate alignment of pole pieces.

To insure maximum heat transfer to the outside structure, and to eliminate relative motion between helix turns, each and every turn of the helix is securely glazed to supporting beryllia wedges. The back side of the wedges has the same radius of curvature as the inside of the helix barrel. The barrel is formed to produce a very close fit between the backs of the beryllia wedges and the barrel inside diameter. The barrel is shrunk onto the wedge-helix assembly by a special thermal technique which results in high-pressure contact between the two surfaces. This contact, coupled with the large surface area on the backs of the wedges and the inherent high thermal conductivity of beryllia permits maximum heat transfer to the barrel, and thence radially outward through the pole pieces and magnets.

The magnet assembly is thermally bonded to the tube's surrounding metal shell which is secured to a heat sink. Heat transfer from the tube to the mount is entirely by conduction. The heat dissipation is minimized by excellent beam focusing and using a depressed collector. Depending upon the particular application, the heat sink may require forced-air cooling. It is recommended that the heat sink base-plate temperature be maintained between -10°C and $+55^{\circ}\text{C}$. Other versions of the WJ-231 are available which can meet higher power or higher gain over narrower frequency ranges and a wider environmental temperature range.

Typical values of overall efficiency, saturation gain, and saturated power output are shown in Fig. 1. Although not specified on the attached Tentative Specification sheet, the WJ-231-5 is capable of operating over an extended frequency range from 4.0 to 9.0 GHz. In such application, the tube can be expected to produce a typical saturated output power of 35 watts and typical saturation gain of 30 dB. The gain, which is minimum at band edge, may be improved at one end of the band by slight adjustment of anode and helix voltages; this will result in a gain decrease at the opposite band edge. By operating the collector depressed, an overall efficiency of 23% is guaranteed. More than 26% is typical from 4.0 to 9.0 GHz, and, over narrower frequency ranges, efficiencies exceeding 30% can be achieved.

Phase characteristics of the WJ-231-5 are presented in Fig. 2. The slope of the phase shift versus power input curve yields an AM to PM conversion of less than 2 degrees per dB at saturation.

Phase shift is a smooth linear function of helix voltage and is relatively insensitive to frequency. Phase deviation from linear phase change is typically less than 1.5 degrees per 12.5 MHz.

Noise figure for the WJ-231-5 is usually less than 30 dB. Figure 3 shows typical characteristics over the frequency range 7.0 to 9.0 GHz.

Other versions of the WJ-231 are available which have improved performance characteristics over narrower frequency ranges. Further technical information is presented in the Tentative Specification, the Outline Drawing of Fig. 4 and the suggested power supply connection diagram of Fig. 5.

Additional information on the WJ-231-5 may be obtained through our representative in your area, or by contacting Watkins-Johnson Company, 3333 Hillview Avenue, Palo Alto, California. Inquiries to our Palo Alto facility should be addressed to the attention of Applications Engineering.

TENTATIVE SPECIFICATION

WJ-231-5

5.0 TO 8.5 GHz, 35 WATT CW PPM-FOCUSED TRAVELING-WAVE TUBE

<u>PERFORMANCE</u>	<u>Typical</u>	<u>Guaranteed</u>
Frequency	4.4 - 9.0 GHz	5.0 - 8.5 GHz
Saturation Gain	34 dB	30 dB, min.
Saturation Power Output	38 W	35 W, min.
Small Signal Gain	40 dB	36 dB, min.
Efficiency (with collector depression)	26 - 30%	23%, min.
Noise Figure	30 dB	35 dB, max.

<u>ELECTRICAL CHARACTERISTICS</u>	<u>Typical</u>	<u>Range</u>
Heater Voltage	5.5 V	5.5 \pm 0.3 V
Heater Current	0.8 A	1.0 A, max.
Anode Voltage	4750 V	4750 \pm 150 V
Anode Current	0.1 mA	1.0 mA, max.
Helix Voltage	4600 V	4600 \pm 150 V
Helix Current	2 mA	8 mA, max.
Collector Voltage	2000 V	1800 - 3000 V
Collector Current	60 mA	70 mA, max.
Cathode Current	62 mA	70 mA, max.

<u>MECHANICAL CHARACTERISTICS</u>	
Width	3.20 inches
Height (connectors included)	3.20 inches
Length	12.50 inches
Weight	4.50 lbs
Cooling	Conduction
Focusing	PPM
RF Connector	TNC Female
DC Connections	12 inch flying leads

ENVIRONMENTAL CHARACTERISTICS

Can be qualified to meet requirements of MIL-E-5400.

WATKINS-JOHNSON COMPANY
Stanford Industrial Park
3333 Hillview Avenue
Palo Alto, California 94304

Telephone: (415) 326-8830
Teletype: 910-373-1253

July 1966

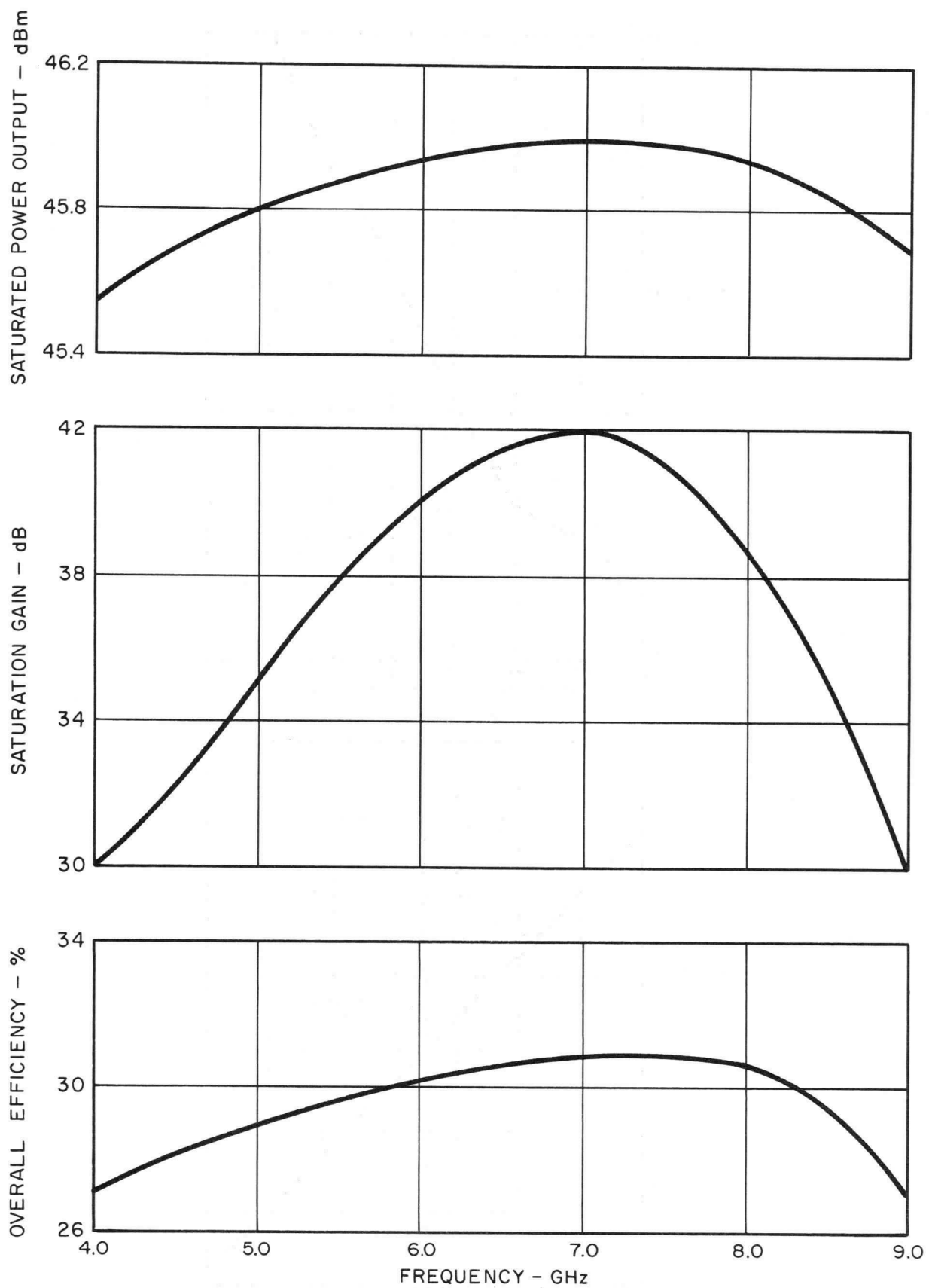

FIG. 1. WJ-231-5 TYPICAL PERFORMANCE CHARACTERISTICS

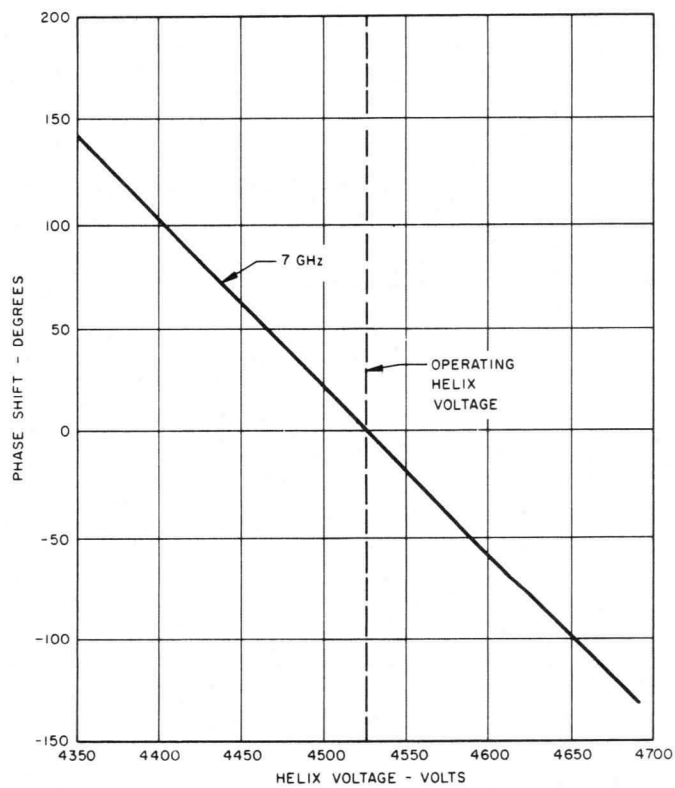
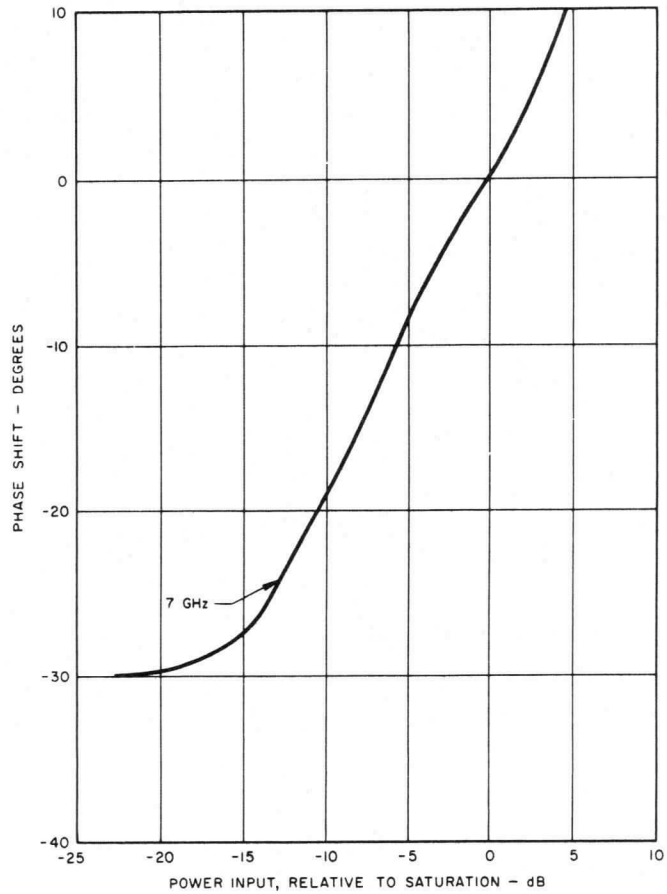

FIG. 2. WJ - 231 - 5 TYPICAL PHASE CHARACTERISTICS

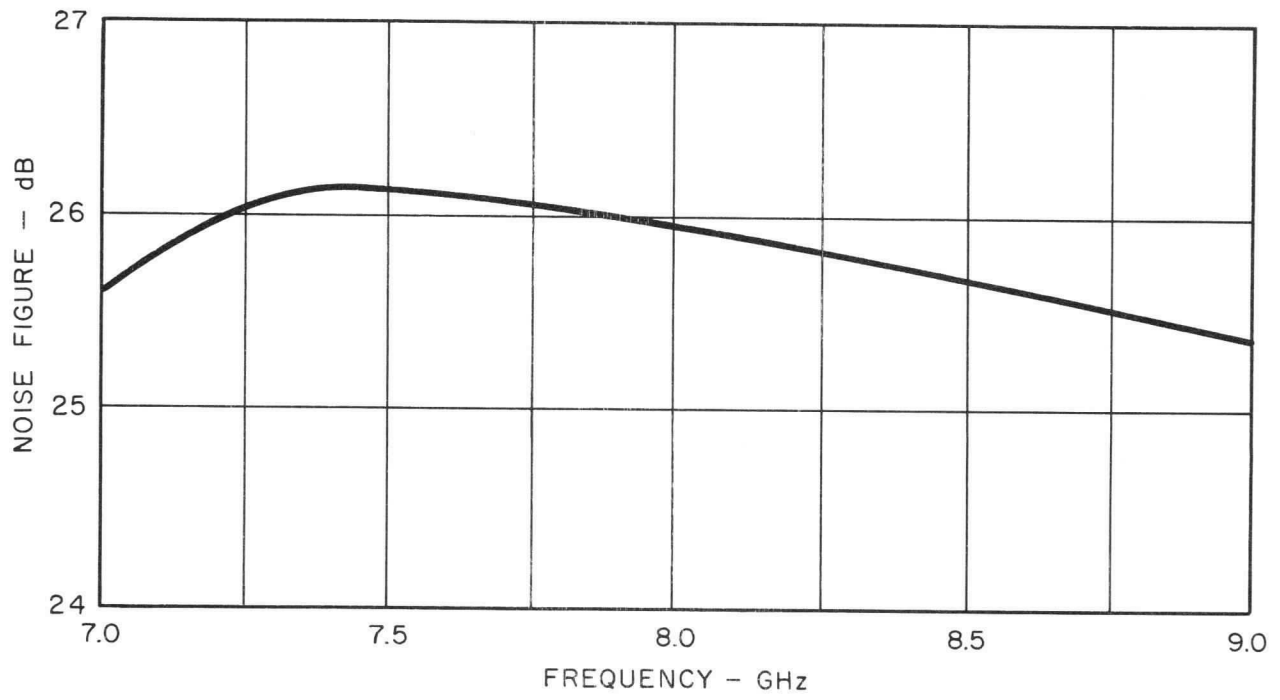
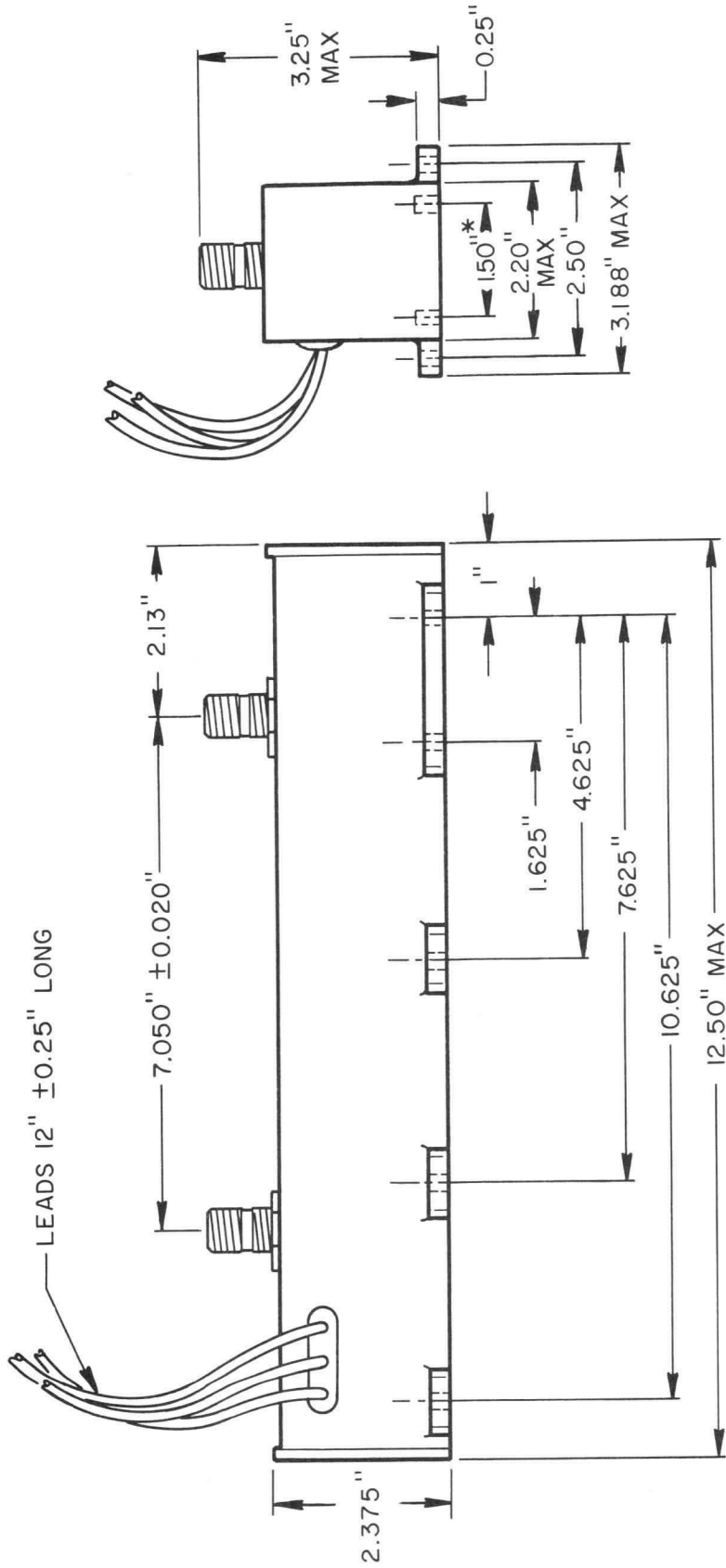

FIG. 3. WJ - 231 - 5 TYPICAL NOISE FIGURE PERFORMANCE



OPTIONAL MODEL WITHOUT MOUNTING FLANGES ALSO AVAILABLE

* DISTANCE BETWEEN MOUNTING HOLES WITH 8-32 UNC (SST INSERTS) 1/4" DP (10) PLACES ON MODELS WITHOUT MOUNTING FLANGES.

FIG. 4. WJ - 231-5 OUTLINE DRAWING

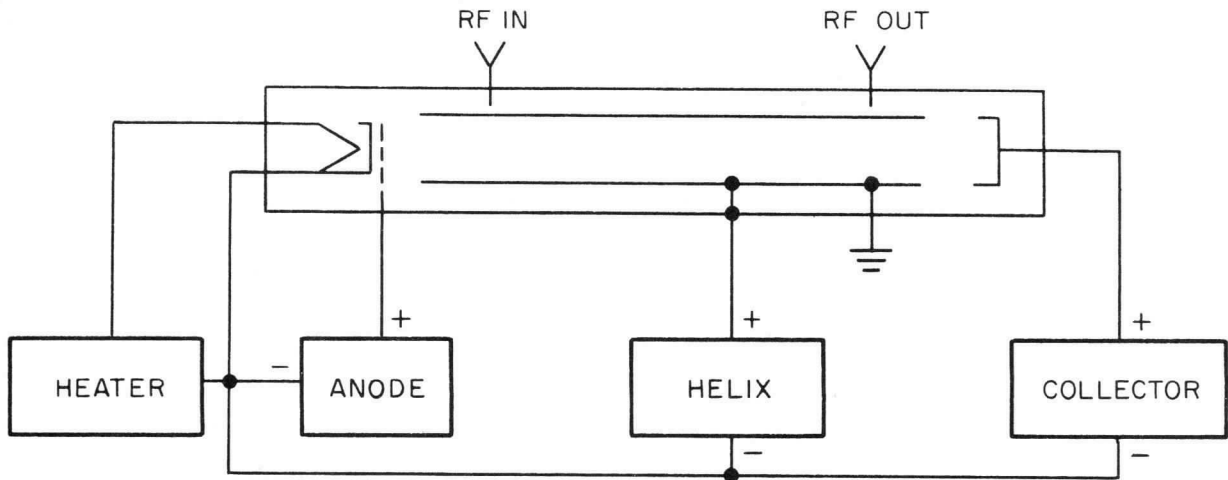

HEATER 0-6 VOLTS AC AT 1 AMPERE MAXIMUM
 ANODE 0- 5000 VOLTS AT 1 mA MAXIMUM
 HELIX 0 - 4800 AT 10 mA MAXIMUM
 COLLECTOR 1800 - 2200 VOLTS AT 70 mA MAXIMUM

PREFERRED CONNECTION FOR LABORATORY -TYPE POWER SUPPLY CONFIGURATION.

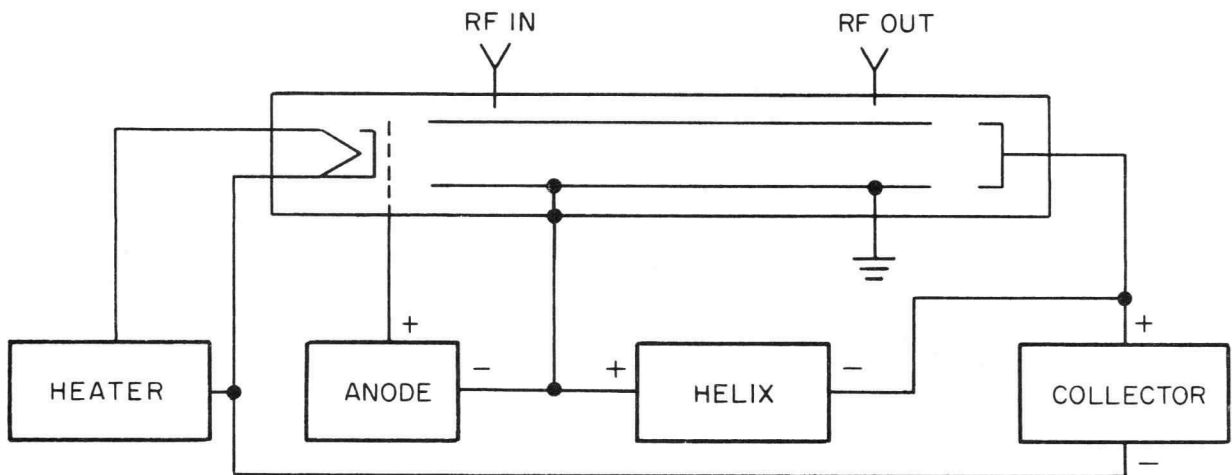

HEATER 0-6 VOLTS AC AT 1A MAXIMUM
 ANODE 0- 200 VOLTS AT 1 mA MAXIMUM
 HELIX 0 - 3000 VOLTS AT 10 mA MAXIMUM
 COLLECTOR 1800 - 2200 VOLTS AT 70 mA MAXIMUM

NOTE: WITH THIS CONFIGURATION,
 THE ANODE SUPPLY CANNOT CUT
 OFF TUBE EMISSION.

CONNECTION FOR HIGH EFFICIENCY POWER SUPPLY DESIGN AS USED IN A TYPICAL
 WATKINS - JOHNSON POWER SUPPLY.

FIG. 5. SUGGESTED POWER SUPPLY CONNECTION DIAGRAMS FOR THE WJ - 231-5



Vol. 5, No. 2; March, 1963

WJ-268

1.0 to 2.0 Gc Low-Noise Permanent Magnet
Traveling-Wave Tube with Integral Power Supply

The WJ-268 offers a new concept in ultra low-noise traveling-wave tubes. Completely self-contained, this amplifier requires only an ac line-voltage input, and is adjustment-free.

For the first time, a permanent-magnet focused tube is available which has the same noise figure as the best solenoid-focused tube such as the WJ-212. The completely shielded package may be operated in stacked arrays or next to ferromagnetic material without adverse effect.

This compact amplifier with its integral power supply weighs less than 17 pounds, is 11.5 inches long excluding connectors, and is 4.5 inches in diameter. The total power consumption from the 117-volt ac source is less than 10 watts.

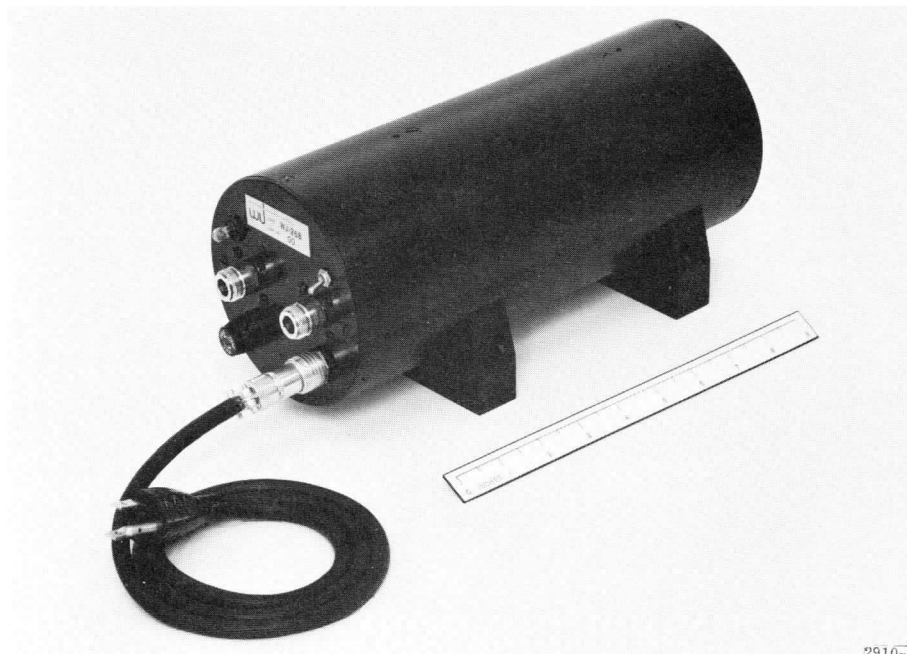

2910-I

The WJ-268 offers a guaranteed maximum noise figure of 5.0 db over the frequency range 1.0 to 2.0 Gc. Small signal gain is 25 db minimum, and saturated power output is nominally -5 dbm.

The tube may be mounted in any orientation without degradation of performance. Rugged construction of the tube, magnet, and power supply assembly assures reliable operation under vibrational forces of 10 g, at frequencies up to 2000 cps. Full specifications are met over the operating temperature range of -54°C to $+85^{\circ}\text{C}$. The environmental characteristics of the WJ-268 meet or exceed the corresponding requirements of MIL-E-5400, Class 2. Where required, the amplifier housing can be made waterproof.

The same conservative design and careful processing techniques which have given long life in other Watkins-Johnson low-noise tubes have been extended to the new family of permanent-magnet focused tubes.

Details of electrical and mechanical characteristics are given on the attached specification sheet.

Any further inquiries may be addressed to our Applications Engineering or to our representative in your area.

TENTATIVE SPECIFICATION

WJ-268

1.0 to 2.0 Gc Low-Noise Permanent-Magnet
Traveling-Wave Tube with Integral Power Supply

PERFORMANCE

	<u>Typical</u>	<u>Guaranteed</u>
Frequency	1.0 to 2.0 Gc	1.0 to 2.0 Gc
Noise figure, terminal	4.5 db	5.0 db max.
Gain, small signal	28 db	25 db min.
VSWR, input and output	1.5:1	2:1 max.
Power output	-5.0 dbm	

ELECTRICAL REQUIREMENTS

	<u>Typical</u>	<u>Range¹</u>
Primary voltage	117 v ac	117 ± 3 v ac
Primary frequency	60 cps	48 to 62 cps
Primary power	8. w	

ENVIRONMENTAL CHARACTERISTICS²

Temperature	-54°C to +85°C
Vibration	
a) .10 inch, double amplitude	5 to 45 cps
b) 10 g, single amplitude	45 to 2000 cps
Shock	15 g, 11 ms

MECHANICAL

Amplifier length (excluding connectors)	11.5 inches, max.
Amplifier diameter	4.5 inches, nom.
Weight	17 pounds, max.
Primary power connection, Deutsch receptacle	DM9601-3P
RF connections	Type N, jack

1. Every tube will meet the guaranteed performance specifications for any voltage lying within these ranges.
2. These environmental characteristics meet or exceed the respective requirements of MIL-E-5400, Class 2.

WATKINS-JOHNSON COMPANY
Stanford Industrial Park
3333 Hillview Avenue
Palo Alto, California
Telephone: DAVenport 6-8830

12 March 1963



Vol. 5, No. 6; August, 1963

WJ-268-2

1.0 to 2.6 Gc LOW-NOISE PERMANENT MAGNET
TRAVELING-WAVE TUBE WITH INTEGRAL POWER SUPPLY

The WJ-268-2 is an extended frequency range version of the WJ-268. For the first time, an ultra-low-noise traveling-wave tube is available which has more than an octave bandwidth coverage.

Completely self-contained, this amplifier requires only an ac line-voltage input, and is adjustment-free. The shielded package may be operated in stacked arrays or next to ferromagnetic material without adverse effect.

This compact amplifier with its integral power supply weighs less than 17 pounds, is 12.0 inches long excluding connectors, and is 4.5 inches in diameter. The total power consumption from the 117-volt ac source is less than 10 watts.

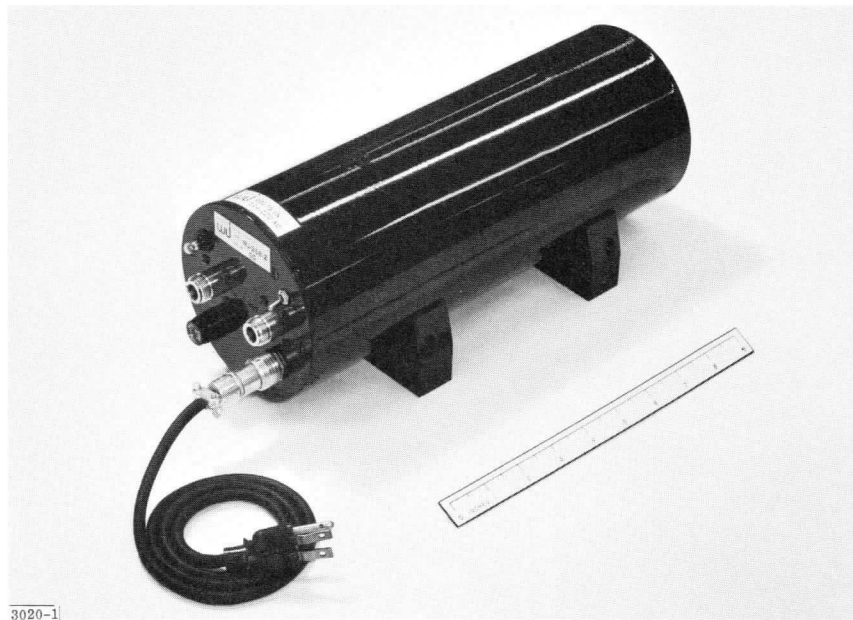

The WJ-268 offers a guaranteed maximum noise figure of 5.5 db over the frequency range 1.0 to 2.6 Gc. Small signal gain is 25 db minimum, and saturated power output is nominally -5 dbm.

The tube may be mounted in any orientation without degradation of performance. Rugged construction of the tube, magnet, and power supply assembly assures reliable operation under vibrational forces of 10 g, at frequencies up to 2000 cps. Full specifications are met over the operating temperature range of -54°C to $+85^{\circ}\text{C}$. The environmental characteristics of the WJ-268-2 meet or exceed the corresponding requirements of MIL-E-5400, Class 2. Where required, the amplifier housing can be made dripproof.

The same conservative design and careful processing techniques which have given long life in other Watkins-Johnson low-noise tubes have been extended to the wideband permanent-magnet focused tubes.

Details of electrical and mechanical characteristics are given on the attached specification sheet.

Any further inquiries may be addressed to our Applications Engineering or to our representative in your area.

TENTATIVE SPECIFICATION

WJ-268-2

1.0 to 2.6 Gc LOW-NOISE PERMANENT MAGNET TRAVELING-WAVE TUBE WITH INTEGRAL POWER SUPPLY

PERFORMANCE

	<u>Typical</u>	<u>Guaranteed</u>
Frequency	1.0-2.6 Gc	1.0-2.6 Gc
Noise figure, terminal	4.5 db	5.5 db max.
Gain, small signal	28 db	25 db min.
VSWR, input and output	1.5:1	2:1 max.
Power output	-5.0 dbm	

ELECTRICAL REQUIREMENTS

	<u>Typical</u>	<u>Range¹</u>
Primary voltage	117 v ac	117 ± 3 v ac
Primary frequency	60 cps	48 to 420 cps
Primary power	8.0 w	

ENVIRONMENTAL CHARACTERISTICS²

Temperature	-54 ⁰ to +85 ⁰ C
Vibration	
a) .10 inch, double amplitude	5 to 45 cps
b) 10 g, single amplitude	45 to 2000 cps
Shock	15 g, 11 ms

MECHANICAL CHARACTERISTICS

Amplifier length (excluding connectors)	12.0 inches, max.
Amplifier height	4.75 inches, max.
Weight	17 pounds, max.
Primary power connection, Deutsch receptacle	DM9601-3P
RF connections	Type N, jack

1. Every tube will meet the guaranteed performance specifications within these ranges.
2. These environmental characteristics meet or exceed the respective requirements of MIL-E-5400, Class 2.

WATKINS-JOHNSON COMPANY
Stanford Industrial Park
3333 Hillview Avenue
Palo Alto, California

1 August 1963

Telephone: Area Code 415
326-8830



Vol. 5, No. 3; March, 1963

WJ-269

2.0 to 4.0 Gc Low-Noise Permanent-Magnet Traveling-Wave Tube with Integral Power Supply

The WJ-269 is the second in a series of new ultra-low-noise traveling-wave tubes available from Watkins-Johnson Company. Like the L-band WJ-268, it is completely self-contained, requires only an ac line-voltage input, and is adjustment free.

The WJ-269 has the same low noise figure as the solenoid-focused WJ-211 but has greater minimum gain, and is focused in a small permanent magnet. The completely shielded package may be operated in stacked arrays or next to ferromagnetic material without adverse effect.

This compact amplifier with its integral power supply weighs less than 17 pounds, is 11.5 inches long excluding connectors, and is 4.5 inches in diameter. The total power consumption from the 117-volt ac source is less than 10 watts.

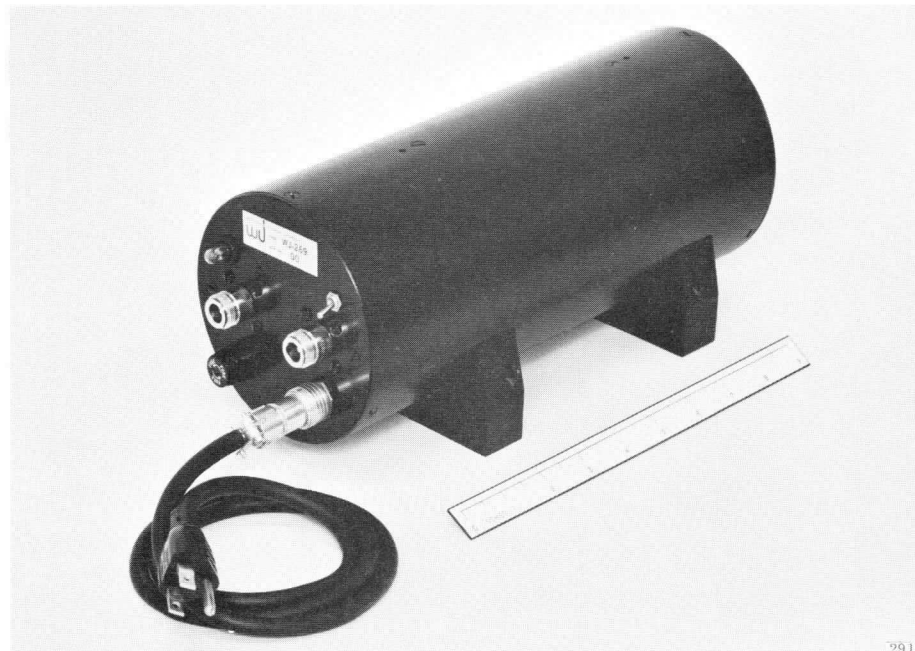

The WJ-269 offers a guaranteed maximum noise figure of 5.5 db over the frequency range 2.0 to 4.0 Gc. Small signal gain is 25 db minimum, and saturated power output is nominally -5 dbm.

The tube may be mounted in any orientation without degradation of performance. Rugged construction of the tube, magnet, and power supply assembly assures reliable operation under vibrational forces of 10 g, at frequencies up to 2000 cps. Full specifications are met over the operating temperature range of -54° to $+85^{\circ}\text{C}$. The environmental characteristics of the WJ-269 meet or exceed the corresponding requirements of MIL-E-5400, Class 2. Where required, the amplifier housing can be made waterproof.

The same conservative design and careful processing techniques which have given long life in other Watkins-Johnson low-noise tubes have been extended to the new family of permanent-magnet focused tubes.

Details of electrical and mechanical characteristics are given on the attached specification sheet.

Any further inquiries may be addressed to our Applications Engineering or to our representative in your area.

TENTATIVE SPECIFICATION

WJ-269

2.0 to 4.0 Gc Low-Noise Permanent-Magnet Traveling-Wave Tube with Integral Power Supply

PERFORMANCE

	<u>Typical</u>	<u>Guaranteed</u>
Frequency	2.0 to 4.0 Gc	2.0 to 4.0 Gc
Noise figure, terminal	4.5 db	5.5 db max.
Gain, small signal	28 db	25 db min.
VSWR, input and output	1.5:1	2:1 max.
Power output	-5.0 dbm	

ELECTRICAL REQUIREMENTS

	<u>Typical</u>	<u>Range¹</u>
Primary voltage	117 v ac	117 ±3 v ac
Primary frequency	60 cps	48 to 62 cps
Primary power	8 w	

ENVIRONMENTAL CHARACTERISTICS²

Temperature	-54°C to +85°C
Vibration	
a) .10 inch, double amplitude	5 to 45 cps
b) 10 g, single amplitude	45 to 2000 cps
Shock	15 g, 11 ms

MECHANICAL CHARACTERISTICS

Amplifier length (excluding connectors)	11.5 inches, max.
Amplifier diameter	4.5 inches, nom.
Weight	17 pounds, max.
Primary power connection, Deutsch receptable	DM9601-3P
RF connections	Type N, jack

1. Every tube will meet the guaranteed performance specifications for any voltage lying within these ranges.
2. These environmental characteristics meet or exceed the respective requirements of MIL-E-5400, Class 2.

WATKINS-JOHNSON COMPANY
Stanford Industrial Park
3333 Hillview Avenue
Palo Alto, California

12 March 1963

Telephone: DAvenport 6-8830



Vol. 5, No. 7; August, 1963

WJ-269-1

2.3 to 4.5 Gc LOW-NOISE PERMANENT-MAGNET TRAVELING-WAVE TUBE WITH INTEGRAL POWER SUPPLY

The WJ-269-1 is a version of the WJ-269 family with the frequency range shifted to match a popular segment of "S" and "C" band. Like the WJ-269, it is completely self-contained, requires only an ac line voltage input, and is adjustment free.

The permanent magnet shielded package may be operated in stacked arrays or next to ferromagnetic material without adverse effect.

This compact amplifier with its integral power supply weighs less than 17 pounds, is 12 inches long excluding connectors, and is 4.5 inches in diameter. The total power consumption from the 117-volt ac source is less than 10 watts.



The WJ-269-1 offers a guaranteed maximum noise figure of 6.0 db over the frequency range 2.3 to 4.5 Gc. Small signal gain is 25 db minimum, and saturated power output is nominally -5 dbm.

The tube may be mounted in any orientation without degradation of performance. Rugged construction of the tube, magnet, and power supply assembly assures reliable operation under vibrational forces of 10 g, at frequencies up to 2000 cps. Full specifications are met over the operating temperature range of -54° to $+85^{\circ}\text{C}$. The environmental characteristics of the WJ-269-1 meet or exceed the corresponding requirements of MIL-E-5400, Class 2. Where required, the amplifier housing can be made dripproof.

The same conservative design and careful processing techniques which have been given long life in other Watkins-Johnson low-noise tubes have been extended to the wideband permanent-magnet focused tubes.

Any further inquiries may be addressed to our Applications Engineering or to our representative in your area.

TENTATIVE SPECIFICATION

WJ-269-1

2.3 to 4.5 Gc LOW-NOISE PERMANENT-MAGNET TRAVELING-WAVE TUBE WITH INTEGRAL POWER SUPPLY

PERFORMANCE

	<u>Typical</u>	<u>Guaranteed</u>
Frequency	2.3-4.5 Gc	2.3-4.5 Gc
Noise figure, terminal	5.0 db	6.0 db max.
Gain, small signal	28 db	25 db min.
VSWR, input and output	1.5:1	2:1 max.
Power output	-5.0 dbm	

ELECTRICAL REQUIREMENTS

	<u>Typical</u>	<u>Range¹</u>
Primary voltage	117 v ac	117 ± 3 v ac
Primary frequency	60 cps	48 to 420 cps
Primary power	8.0 w	

ENVIRONMENTAL CHARACTERISTICS²

Temperature	-54°C to +85°C
Vibration	
a) .10 inch, double amplitude	5 to 45 cps
b) 10 g, single amplitude	45 to 2000 cps
Shock	15 g, 11 ms

MECHANICAL CHARACTERISTICS

Amplifier length (excluding connectors)	12.0 inches, max.
Amplifier height	4.75 inches, max.
Weight	17 pounds, max.
Primary power connection, Deutsch receptacle	DM9601-3P
RF connections	Type N, jack

1. Every tube will meet the guaranteed performance specifications within these ranges.
2. These environmental characteristics meet or exceed the respective requirements of MIL-E-5400, Class 2.

WATKINS-JOHNSON COMPANY
Stanford Industrial Park
3333 Hillview Avenue
Palo Alto, California

1 August 1963

Telephone: Area Code 415
326-8830



Vol. 6, No. 2; February, 1964

WJ-271

4.0 TO 8.0 GC LOW-NOISE PERMANENT-MAGNET TRAVELING-WAVE TUBE WITH INTEGRAL POWER SUPPLY

The WJ-271 is the C-band member of the Watkins-Johnson family of self-contained ultra-low-noise amplifiers that cover the spectrum from 1.0 to 12.0 Gc. Identical in size and external features with the WJ-268, WJ-269, and WJ-276, this tube requires only an ac line-voltage input and is adjustment-free.

The WJ-271 amplifier package includes a shielded permanent-magnet that is not adversely affected by adjacent PM tubes or ferromagnetic material. Also integral with the package is a factory-set power supply whose total power consumption from the 117-volt ac source is less than 20 watts. All components are regulated or compensated for full specification performance from -54°C to $+71^{\circ}\text{C}$.

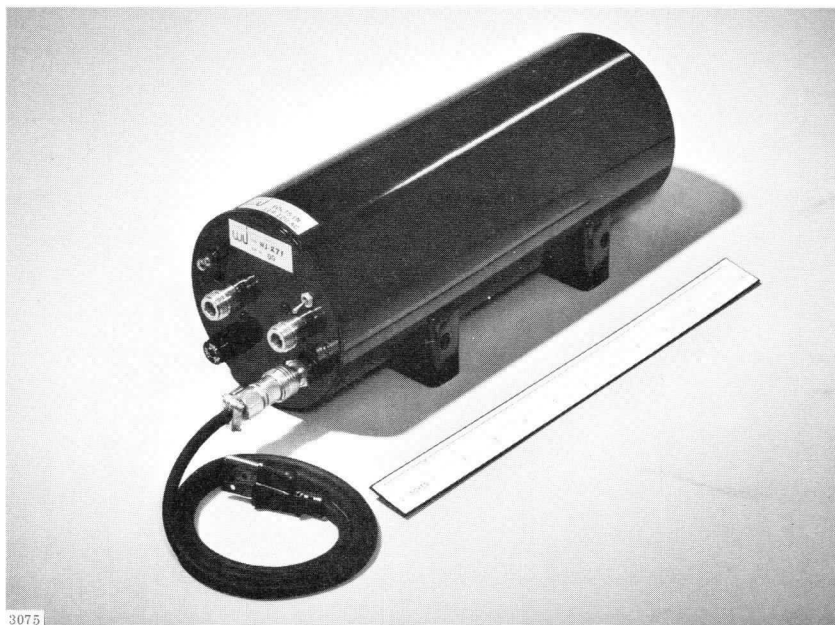

The weight of the amplifier is less than 17 pounds and it occupies a space, excluding connectors, of 12 inches long by 4.75 inches high.

The guaranteed maximum noise figure over the frequency range of 4.0 to 8.0 Gc is 6.5 db. Small signal gain is 25 db minimum and the saturated power output is nominally 0 dbm.

The line voltage requirement of 117 ± 3 v ac corresponds to normal heater voltage regulation supplied for low noise amplifiers. Operation over the range 105 to 125 v ac will in no way damage the amplifier but may result in a maximum increase in the noise figure of 0.5 db. Units can be supplied on special order that will operate over the range of 105 to 125 v ac with no degradation of noise figure.

Installation and operation are simplified by the rugged construction of the WJ-271. When mounted in any orientation by its four threaded mounting holes, it can withstand vibrational forces of over 5 g at frequencies up to 2000 cps and shock in any plane of over 15 g, 11 millisecond duration. These environmental characteristics meet or exceed the corresponding requirements of MIL-E-5400, Class 2. Where required, the amplifier housing can be made drip-proof.

Conservative cathode loading and rigorous manufacturing process control assures the same long life in the WJ-271 as proven in other Watkins-Johnson low-noise tubes. Tubes of similar design are exceeding operating life times of 10,000 hours.

Details of electrical and mechanical characteristics are given in the attached specification sheets. These include the WJ-271-2 which covers the band 4.3 to 7.35 Gc with a maximum noise figure of 6.0 db.

Any further inquiries may be addressed to Application Engineering or our representative in your area.

TENTATIVE SPECIFICATION

WJ-271

4.0 TO 8.0 GC LOW-NOISE PERMANENT-MAGNET TRAVELING-WAVE TUBE WITH INTEGRAL POWER SUPPLY

PERFORMANCE

	<u>Typical</u>	<u>Guaranteed</u>
Frequency	4.0-8.0 Gc	4.0-8.0 Gc
Noise figure, terminal	5.5 db	6.5 db max.
Gain, small signal	28 db	25 db min.
VSWR, input and output	1.5:1	2:1 max.
Power output	0 dbm	

ELECTRICAL REQUIREMENTS

	<u>Typical</u>	<u>Range</u> ¹
Primary voltage	117 v ac	117 ± 3 v ac
Primary frequency	60 cps	48 to 420 cps
Primary power	17 w	

ENVIRONMENTAL CHARACTERISTICS²

Temperature	-54°C to +71°C
Vibration	
a) .10 inch, double amplitude	5 to 30 cps
b) 5 g, single amplitude	30 to 2,000 cps
Shock	15 g, 11 ms

MECHANICAL CHARACTERISTICS

Amplifier length (excluding connectors)	12 inches, max.
Amplifier height and width	4.75 inches, max.
Weight	17 pounds max.
Primary power connection, Deutsch receptacle	DM9601-3P
RF connections (50 ohms, nominal)	Type N, jack

1. Every tube will meet the guaranteed performance specifications for any voltage lying within these ranges.
2. These environmental characteristics meet or exceed the respective requirements for MIL-E-5400, Class 2.

WATKINS-JOHNSON COMPANY
Stanford Industrial Park
3333 Hillview Avenue
Palo Alto, California

16 December 1963

Telephone: (415) 326-8830

TENTATIVE SPECIFICATION

WJ-271-2

4.3 TO 7.35 GC LOW-NOISE PERMANENT-MAGNET TRAVELING-WAVE TUBE WITH INTEGRAL POWER SUPPLY

PERFORMANCE

	<u>Typical</u>	<u>Guaranteed</u>
Frequency	4.3-7.35 Gc	4.3-7.35 Gc
Noise figure, terminal	5.0 db	6.0 db max.
Gain, small signal	28 db	25 db min.
VSWR, input and output	1.5:1	2:1 max.
Power output	0 dbm	

ELECTRICAL REQUIREMENTS

	<u>Typical</u>	<u>Range</u> ¹
Primary voltage	117 v ac	117 ± 3 v ac
Primary frequency	60 cps	48 to 420 cps
Primary power	17 w	

ENVIRONMENTAL CHARACTERISTICS²

Temperature	-54°C to +71°C
Vibration	
a) .10 inch, double amplitude	5 to 30 cps
b) 5 g, single amplitude	30 to 2,000 cps
Shock	15 g, 11 ms

MECHANICAL CHARACTERISTICS

Amplifier length (excluding connectors)	12 inches, max.
Amplifier height and width	4.75 inches, max.
Weight	17 pounds max.
Primary power connection, Deutsch receptacle	DM9601-3P
RF connections (50 ohms, nominal)	Type N, jack

1. Every tube will meet the guaranteed performance specifications for any voltage lying within these ranges.
2. These environmental characteristics meet or exceed the respective requirements for MIL-E-5400, Class 2.

WATKINS-JOHNSON COMPANY
Stanford Industrial Park
3333 Hillview Avenue
Palo Alto, California

Telephone: (415) 326-8830

16 December 1963

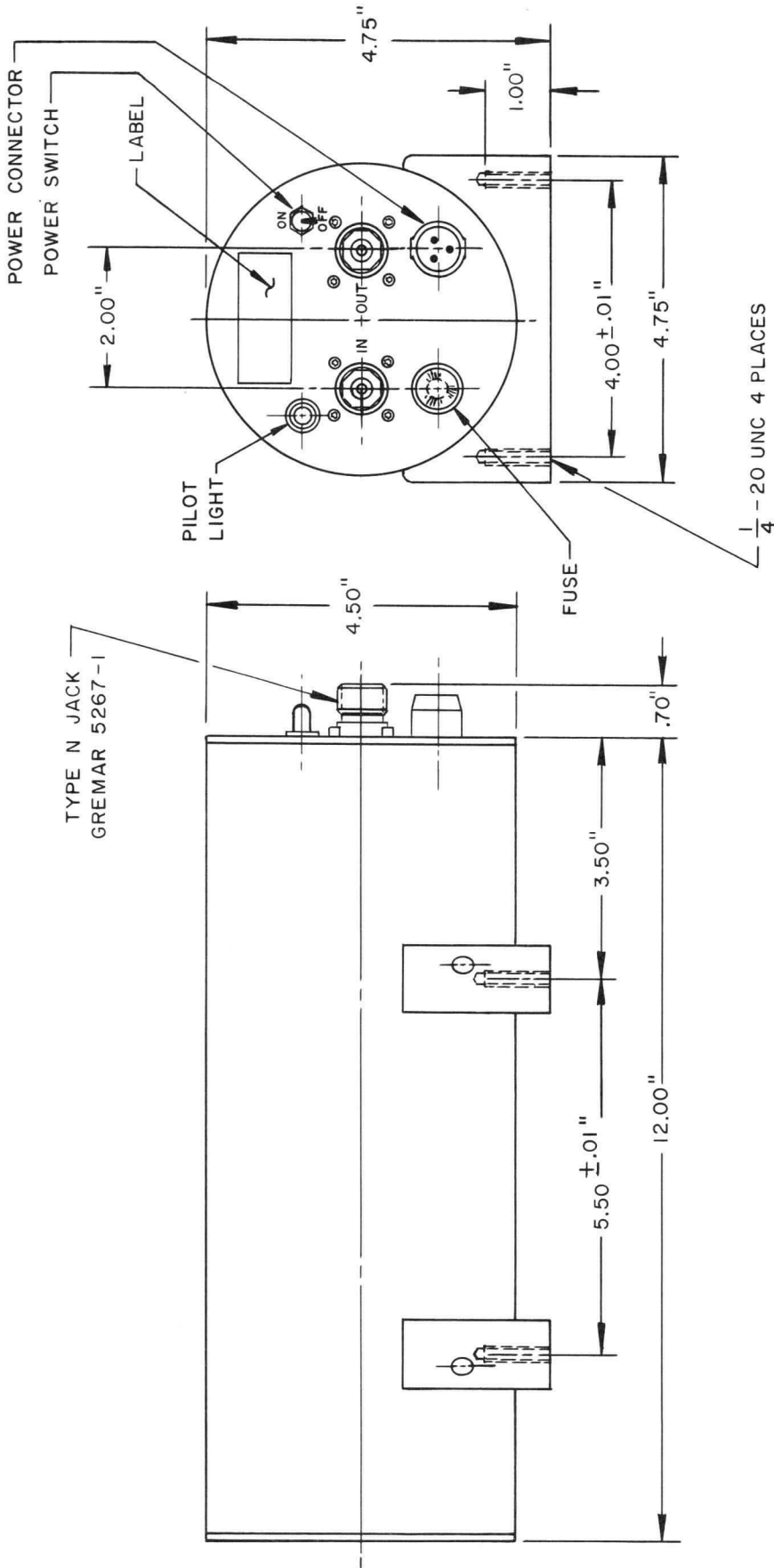

POWER CONNECTIONS	
DEUTSCH DM9601-3P	
PIN	CONNECTION
1	117 VAC
2	GROUND
3	117 VAC

OUTLINE DRAWING OF THE WJ-271



Vol. 5, No. 9, October, 1963

WJ-276

8 TO 12 Gc LOW-NOISE PERMANENT-MAGNET
TRAVELING-WAVE TUBE WITH INTEGRAL POWER SUPPLY

The WJ-276 is the new X-band low-noise traveling-wave tube available from Watkins-Johnson Company. It is completely self-contained, requires only an ac line-voltage input, and is adjustment-free.

The WJ-276 has a typical noise figure of 7 db and is focused in a small permanent magnet. The completely shielded package may be operated in stacked arrays or next to ferromagnetic material without adverse effect.

This compact amplifier with its integral power supply weighs less than 17 pounds, is 12 inches long excluding connectors, and is 4.5 inches in diameter. The total power consumption from the 117-volt ac source is less than 20 watts.

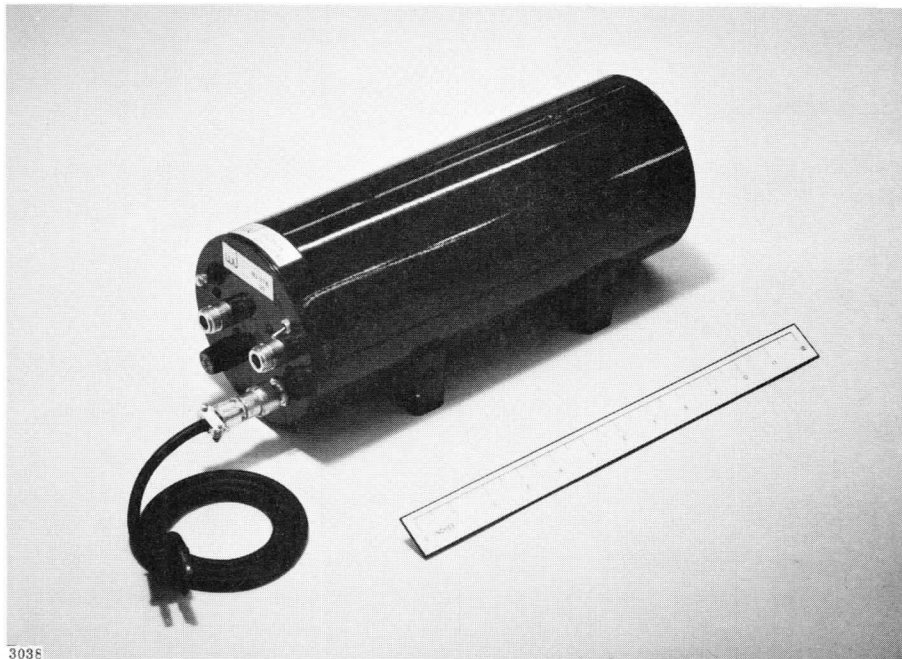

The WJ-276 offers a guaranteed maximum noise figure of 8.5 db over the frequency range 8 to 12 Gc. Small signal gain is 25 db minimum, and saturated power output is nominally 1 milliwatt.

The tube may be mounted in any orientation without degradation of performance. Rugged construction of the tube, magnet, and power supply assembly assures reliable operation under vibrational forces of 5 g, at frequencies up to 2000 cps. Full specifications are met over the operating temperature range of -54° to $+71^{\circ}\text{C}$. The environmental characteristics of the WJ-276 meet or exceed the corresponding requirements of MIL-E-5400, Class 2.

The same conservative design and careful processing techniques which have given long life in other Watkins-Johnson low-noise tubes have been extended to the new family of permanent-magnet focused tubes.

Details of electrical and mechanical characteristics are given on the attached specification sheet.

Any further inquiries may be addressed to our Applications Engineering or to our representative in your area.

TENTATIVE SPECIFICATION

WJ-276

8 TO 12 Gc LOW-NOISE PERMANENT-MAGNET TRAVELING-WAVE TUBE WITH INTEGRAL POWER SUPPLY

PERFORMANCE

	<u>Typical</u>	<u>Guaranteed</u>
Frequency	8 to 12 Gc	8 to 12 Gc
Noise figure, terminal	7.0 db	8.5 db max.
Gain, small signal	28 db	25 db min.
VSWR, input and output	1.5:1	2:1 max.
Power output	0 dbm	

ELECTRICAL REQUIREMENTS

	<u>Typical</u>	<u>Range¹</u>
Primary voltage	117 v ac	117 ±3 v ac
Primary frequency	60 cps	48 to 420 cps
Primary power	17 w	

ENVIRONMENTAL CHARACTERISTICS²

Temperature	-54°C to 71°C
Vibration	
a) .10 inch, double amplitude	5 to 30 cps
b) 5 g, single amplitude	30 to 2000 cps
Shock	15 g, 11 ms

MECHANICAL CHARACTERISTICS

Amplifier length (excluding connectors)	12 inches, max.
Amplifier diameter	4.5 inches, nom.
Weight	17 pounds, max.
Primary power connection, Deutsch receptable	DM9601-3P
RF connections (50 ohms nominal)	Type N, jack

1. Every tube will meet the guaranteed performance specifications for any voltage lying within these ranges.
2. These environmental characteristics meet or exceed the respective requirements of MIL-E-5400, Class 2.

WATKINS-JOHNSON COMPANY
Stanford Industrial Park
3333 Hillview Avenue
Palo Alto, California

October 1963

Telephone: Area Code 415
DAvenport 6-8830

TENTATIVE SPECIFICATION

WJ-276-2

7 TO 11 Gc LOW-NOISE PERMANENT-MAGNET TRAVELING-WAVE TUBE WITH INTEGRAL POWER SUPPLY

PERFORMANCE

	<u>Typical</u>	<u>Guaranteed</u>
Frequency	7 to 11 Gc	7 to 11 Gc
Noise figure, terminal	7.0 db	8.5 db max.
Gain, small signal	28 db	25 db min.
VSWR, input and output	1.5:1	2:1 max.
Power output	0 dbm	

ELECTRICAL REQUIREMENTS

	<u>Typical</u>	<u>Range¹</u>
Primary voltage	117 v ac	117 ±3 v ac
Primary frequency	60 cps	48 to 420 cps
Primary power	17 w	

ENVIRONMENTAL CHARACTERISTICS²

Temperature	-54°C to +71°C
Vibration	
a) .10 inch, double amplitude	5 to 30 cps
b) 5 g, single amplitude	30 to 2000 cps
Shock	15 g, 11 ms

MECHANICAL CHARACTERISTICS

Amplifier length (excluding connectors)	12 inches, max.
Amplifier diameter	4.5 inches, nom.
Weight	17 pounds, max.
Primary power connection, Deutsch receptable	DM9601-3P
RF connections (50 ohms nominal)	Type N, jack

1. Every tube will meet the guaranteed performance specifications for any voltage lying within these ranges.
2. These environmental characteristics meet or exceed the respective requirements of MIL-E-5400, Class 2.

WATKINS-JOHNSON COMPANY

Stanford Industrial Park
3333 Hillview Avenue
Palo Alto, California

October 1963

Telephone: Area Code 415
DAvenport 6-8830



Vol. 5, No. 11, November, 1963

WJ-280

1.0 to 2.6 Gc Low-Noise Permanent-Magnet Traveling-Wave Tube with Integral Power Supply

Watkins-Johnson Company is now extending its family of low-noise permanent-magnet traveling-wave tubes with the addition of the WJ-280. The WJ-280 has a typical noise figure of 6.5 db and has been specially designed for applications where higher gain and increased power output are required over a broader frequency band.

Like other tubes in Watkins-Johnson Company's family of low-noise amplifiers, the WJ-280 incorporates an integral power supply, making the unit completely self-contained, adjustment-free and requiring only an ac line-voltage input. This permanent-magnet focused tube has been designed into a completely shielded package which enables side-by-side operation in stacked arrays or next to ferromagnetic material without any adverse effect.



This compact amplifier with its integral power supply weighs less than 17 pounds, is 12.0 inches long excluding connectors, and is 4.75 inches in height. The total power consumption from the 117 volt ac source is less than 10 watts.

The WJ-280 covers the 1.0 to 2.6 Gc frequency range with a minimum small-signal gain of 35 db. The saturated power output of the tube is nominally 1 milliwatt and it has a guaranteed maximum noise figure of 8.0 db.

The tube may be mounted in any orientation without degradation of performance. Rugged construction of the tube, magnet, and power supply assembly assures reliable operation under vibrational forces of 10 g, at frequencies up to 2000 cps. The environmental characteristics of the WJ-280 meet or exceed the corresponding requirements of MIL-E-5400, Class 2. Where required, the amplifier housing can be made drip-proof.

The same conservative design and careful processing techniques which have given long life in other Watkins-Johnson low-noise tubes have also been extended to this amplifier.

Details of electrical and mechanical characteristics and curves of typical operation can be found on the attached specification sheet.

Any further inquiries may be addressed to our Applications Engineering or to our representative in your area.

TENTATIVE SPECIFICATION

WJ-280, 1.0 to 2.6 Gc Low-Noise Permanent-Magnet Traveling-Wave Tube with Integral Power Supply

<u>PERFORMANCE</u>	<u>Typical</u>	<u>Guaranteed</u>
Frequency	1.0 - 2.6 Gc	1.0 - 2.6 Gc
Noise figure, terminal	6.5 db	8.0 db max.
Gain, small signal	40 db	35 db min.
VSWR, input and output	1.5:1	2:1 max.
Power output	0 dbm	

<u>ELECTRICAL REQUIREMENTS</u>	<u>Typical</u>	<u>Range¹</u>
Primary voltage	117 vac	117 ± 3 vac
Primary frequency	60 cps	48 to 420 cps
Primary power	8.0 w	

<u>ENVIRONMENTAL CHARACTERISTICS²</u>	
Temperature	-54 ⁰ C to +85 ⁰ C
Vibration	
a) .10 inch, double amplitude	5 to 45 cps
b) 10 g, single amplitude	45 to 2000 cps
Shock	15 g, 11 ms

<u>MECHANICAL</u>	
Amplifier length (excluding connectors)	12.0 inches, max.
Amplifier height	4.75 inches, max.
Weight	17 pounds, max.
Primary power connection, Deutsch receptacle	DM9601-3P
RF connections (50 ohms, nominal)	Type N, jack

1. Every tube will meet the guaranteed performance specifications for any voltage lying within these ranges.
2. These environmental characteristics meet or exceed the respective requirements of MIL-E-5400, Class 2.

9 July 1963

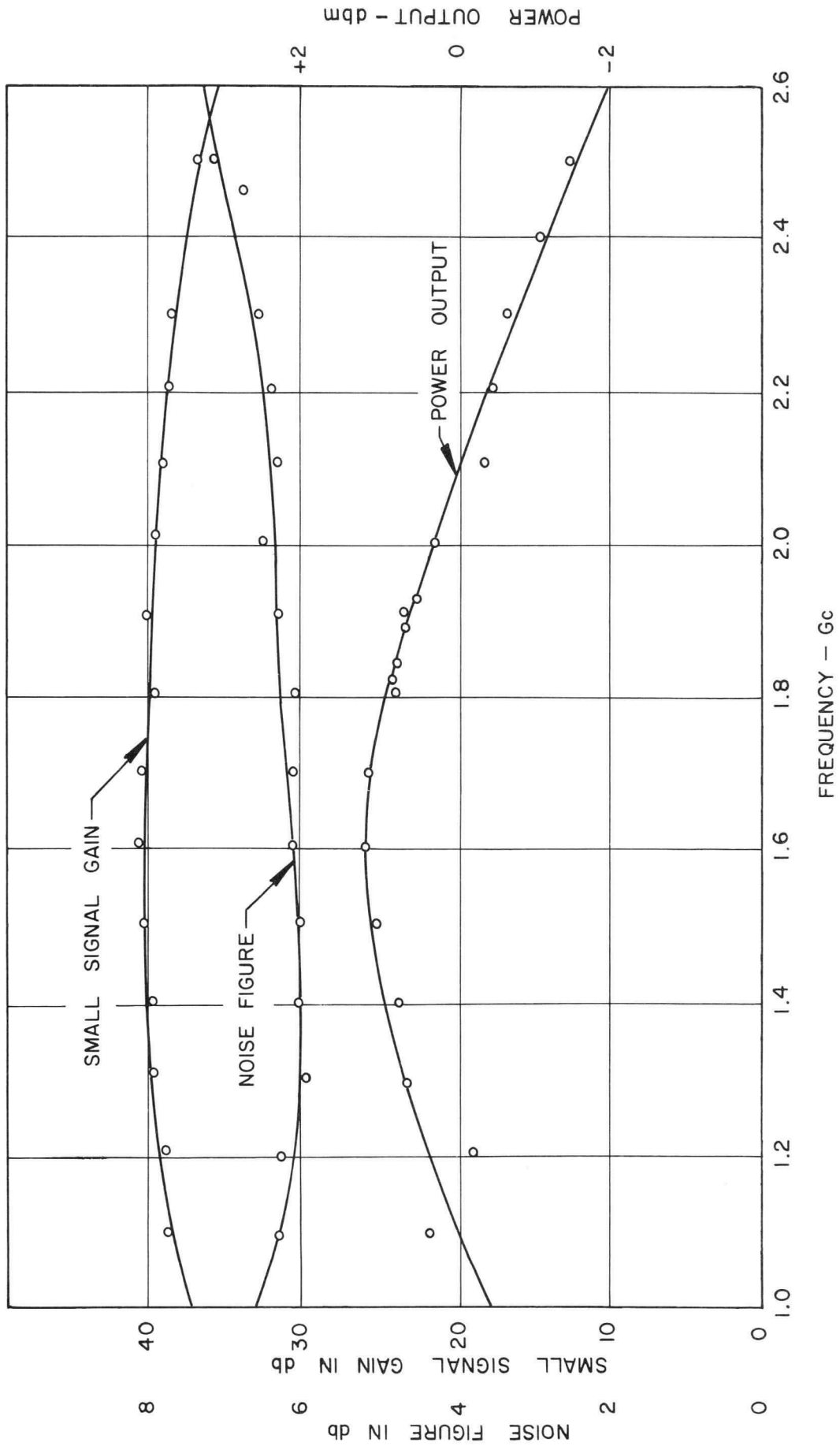

L-BAND LOW-NOISE TRAVELING-WAVE TUBE AMPLIFIER WJ-280 TYPICAL PERFORMANCE

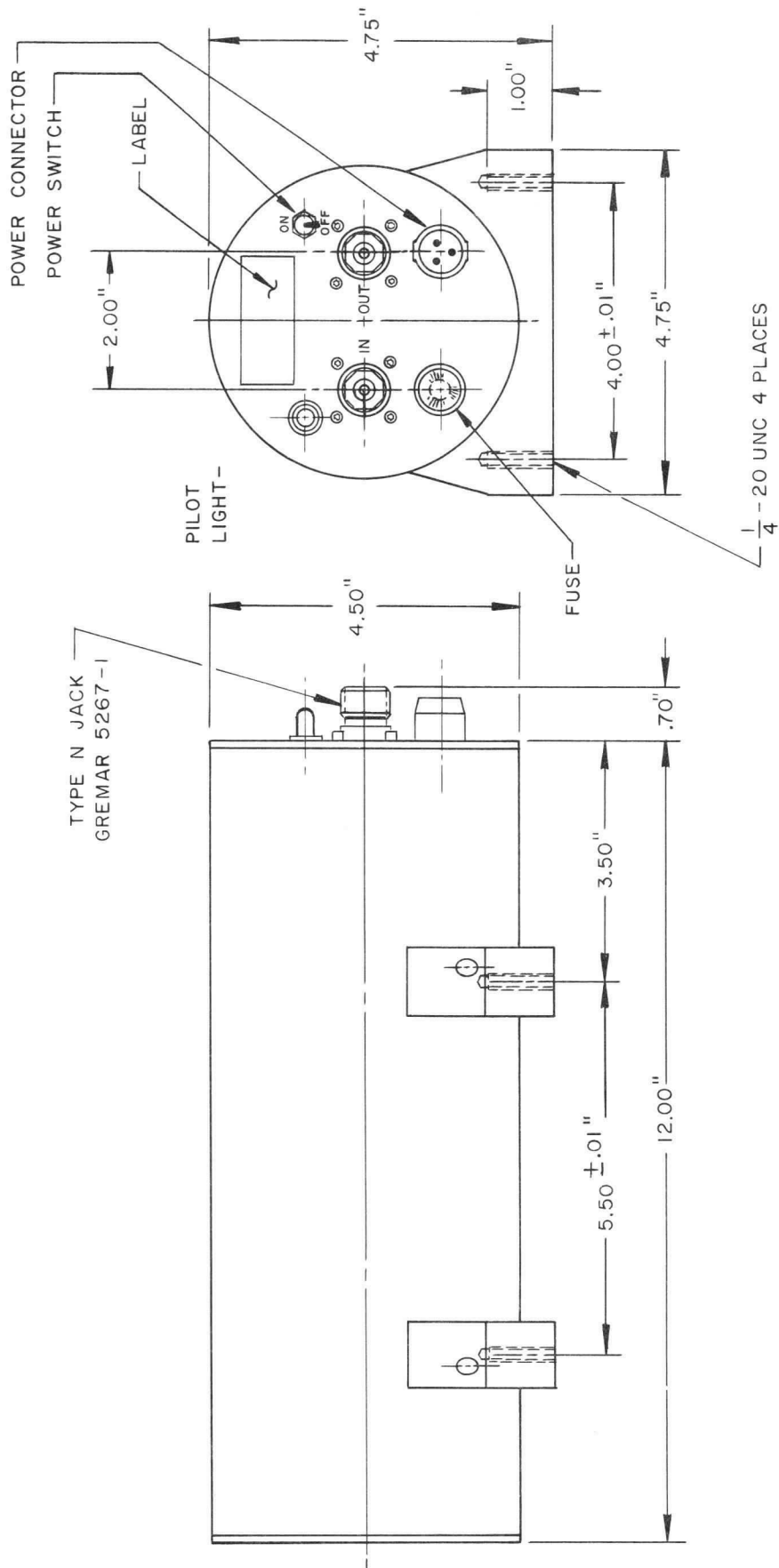

POWER CONNECTIONS	
DEUTSCH DM9601-3P	
PIN	CONNECTION
1	117 VAC
2	GROUND
3	117 VAC

OUTLINE DRAWING OF THE WJ-280



Vol. 6 , No. 3; February, 1964

WJ-281

2.0 TO 4.5 GC LOW-NOISE PERMANENT-MAGNET
TRAVELING-WAVE TUBE WITH INTEGRAL POWER SUPPLY

The WJ-281 is an extension of Watkins-Johnson Company's line of high gain, low-noise traveling-wave tubes. It is a permanent-magnet focused tube which has a typical noise figure of 7.0 db and a typical small signal gain of 40 db.

Like other types in the Watkins-Johnson Company family of low-noise amplifiers, the WJ-281 incorporates an integral power supply, making the unit completely self-contained, adjustment-free and requiring only an ac line-voltage input. This permanent-magnet focused tube has been designed into a completely shielded package which enables side-by-side operation in stacked arrays or next to ferromagnetic material without any adverse effect.



This compact amplifier with its integral power supply weighs less than 17 pounds, is 12.0 inches long excluding connectors, and is 4.75 inches in height and width. The total power consumption from the 117 volt ac source is less than 10 watts.

The WJ-281 covers a frequency range of 2.0 to 4.5 Gc with a minimum small-signal gain of 35 db. The saturated power output of the tube is nominally 1 milliwatt and it has a guaranteed maximum noise figure of 8.0 db.

The line voltage requirement of 117 ± 3 v ac corresponds to normal heater voltage regulation supplied for low noise amplifiers. Operation over the range 105 to 125 v ac will in no way damage the amplifier but may result in a maximum increase in the noise figure of 0.5 db.

The tube may be mounted in any orientation without degradation of performance. Rugged construction of the tube, magnet, and power supply assembly assures reliable operation under vibrational forces of over 10 g, at frequencies up to 2000 cps. The environmental characteristics of the WJ-281 meet or exceed the corresponding requirements of MIL-E-5400, Class 2. Where required, the amplifier housing can be made drip-proof.

The same conservative design and rigid manufacturing process control which have given long life in other Watkins-Johnson low-noise tubes have been extended to this amplifier. Tubes of similar design are exceeding operating life times of 10,000 hours.

Details of electrical and mechanical characteristics and curves of typical operation can be found on the attached specification sheet.

Any inquiries may be addressed to Applications Engineering or to our representative in your area.

TENTATIVE SPECIFICATION

WJ-281

2.0 TO 4.5 GC LOW-NOISE PERMANENT-MAGNET TRAVELING-WAVE TUBE WITH INTEGRAL POWER SUPPLY

PERFORMANCE

	<u>Typical</u>	<u>Guaranteed</u>
Frequency	2.0-4.5 Gc	2.0-4.5 Gc
Noise figure, terminal	7.0 db	8.0 db max.
Gain, small signal	40 db	35 db min.
VSWR, input and output	1.5:1	2:1 max.
Power output	0 dbm	

ELECTRICAL REQUIREMENTS

	<u>Typical</u>	<u>Range¹</u>
Primary voltage	117 v ac	117 ± 3 v ac
Primary frequency	60 cps	48 to 420 cps
Primary power	8.0 w	

ENVIRONMENTAL CHARACTERISTICS²

Temperature	-54°C to +85°C
Vibration	
a) .10 inch, double amplitude	5 to 45 cps
b) 10 g, single amplitude	45 to 2000 cps
Shock	15 g, 11 ms

MECHANICAL

Amplifier length (excluding connectors)	12.0 inches, max.
Amplifier height and width	4.75 inches, max.
Weight	17 pounds, max.
Primary power connection, Deutsch receptacle	DM9601-3P
RF connections (50 ohms, nominal)	Type N, jack

1. Every tube will meet the guaranteed performance specifications for any voltage lying within these ranges.
2. These environmental characteristics meet or exceed the respective requirements of MIL-E-5400, Class 2.

WATKINS-JOHNSON COMPANY
Stanford Industrial Park
3333 Hillview Avenue
Palo Alto, California

16 December 1963

Telephone: (415) 326-8830

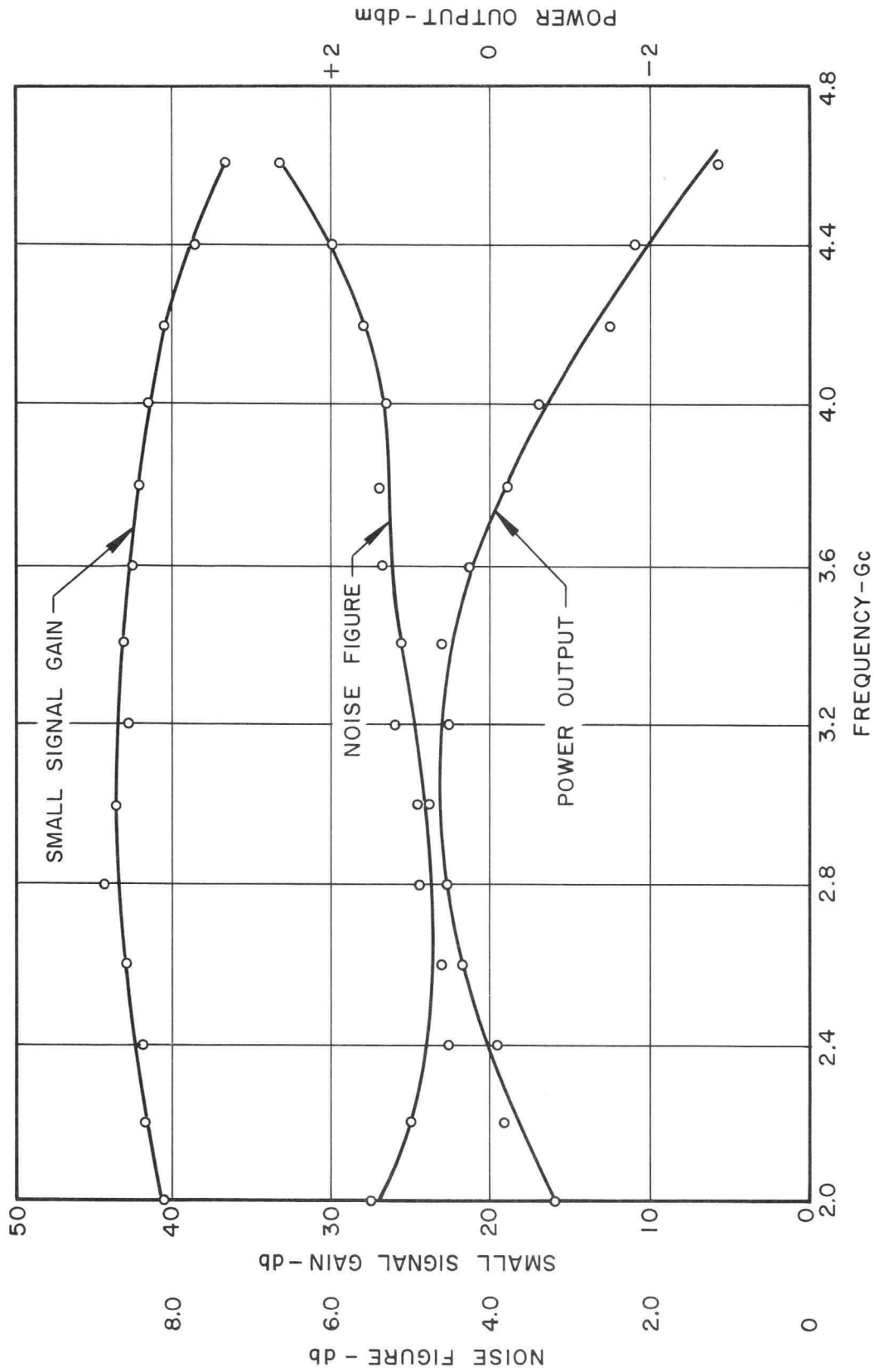

TYPICAL PERFORMANCE OF THE WJ-281
S-BAND LOW-NOISE TRAVELING-WAVE TUBE AMPLIFIER

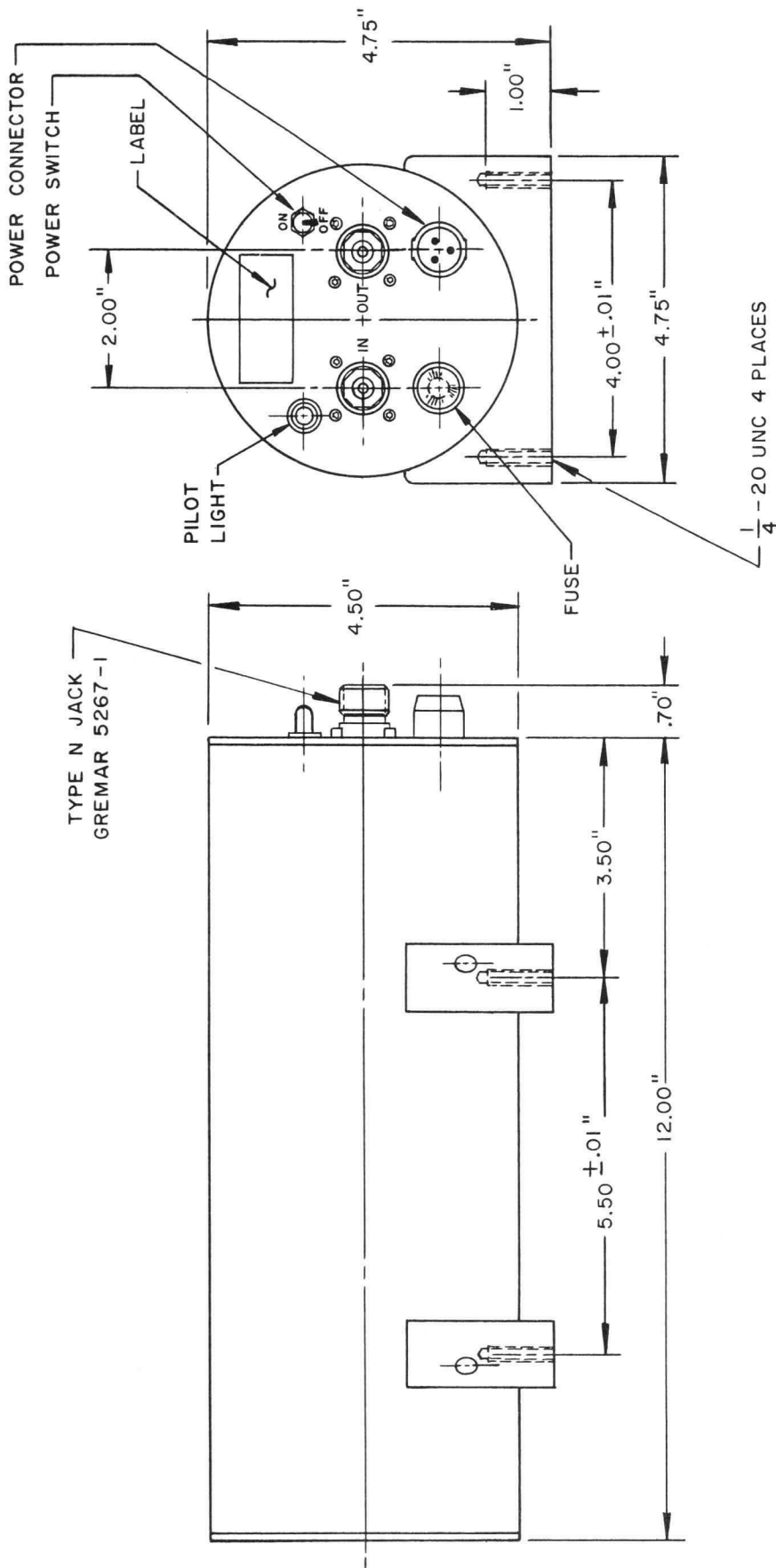

POWER CONNECTIONS	
DEUTSCH DM9601-3P	
PIN	CONNECTION
1	117 VAC
2	GROUND
3	117 VAC

OUTLINE DRAWING OF THE WJ-281



Vol. 6, No. 9, September 1964

WJ-307

12 TO 18 GC LOW-NOISE PERMANENT-MAGNET
TRAVELING-WAVE TUBE WITH INTEGRAL POWER SUPPLY

With the addition of the WJ-307 to its family of PM-focused integral-power-supply amplifiers, Watkins-Johnson Company extends its low-noise amplification coverage through K_u -band. Like its lower-frequency predecessors, the WJ-307 is completely self-contained, adjustment-free, and operates with only an ac line voltage input.

This K_u -band version of the Watkins-Johnson low-noise family has a typical noise figure of 8 db, and can be operated next to similar units or in the vicinity of ferromagnetic materials without degradation of performance. It weighs less than 18 pounds, and measures 12 inches in length (less connectors) by 4.5 inches in diameter. Power drain from the 115-volt ac source is less than 30 watts.

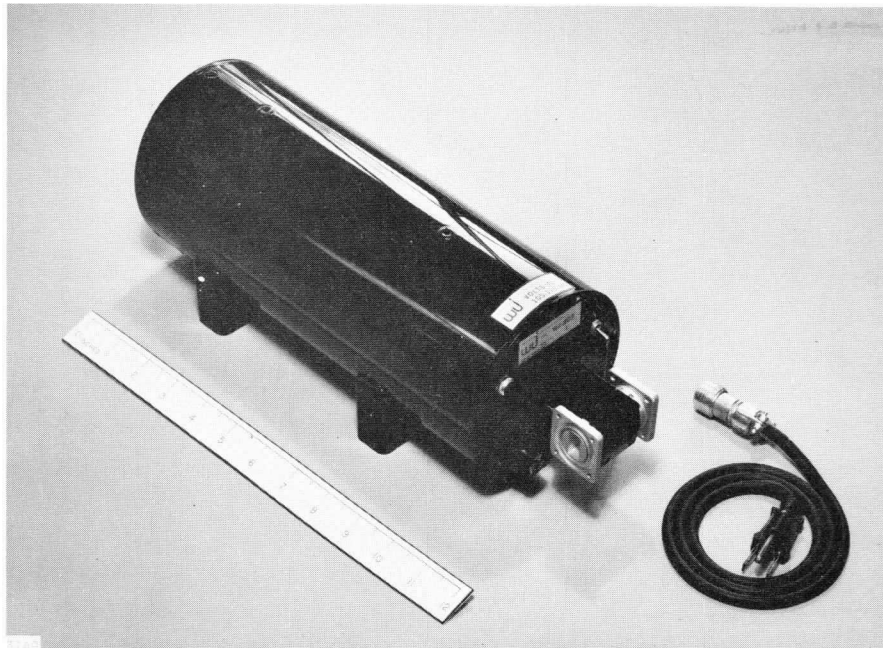

The WJ-307 offers a guaranteed maximum noise figure of 10 db over the frequency range 12 to 18 Gc. Small signal gain is 25 db minimum, and saturated power output is nominally 1 milliwatt.

The tube may be mounted in any orientation without degradation of performance. Rugged construction of the tube, magnet, and power supply assembly assures reliable operation under vibrational forces of 5 g, at frequencies up to 2000 cps. Full specifications are met over the operating temperature range of -54° to $+71^{\circ}\text{C}$. The environmental characteristics of the WJ-307 meet or exceed the corresponding requirements of MIL-E-5400, Class 2.

The same conservative design and careful processing techniques which have given long life in other Watkins-Johnson low-noise tubes have been extended to this new member of the permanent-magnet focused family.

Details of electrical and mechanical characteristics are given on the attached specification sheet.

Any further inquiries may be addressed to our Applications Engineering or to our representative in your area.

TENTATIVE SPECIFICATION

WJ-307

12 TO 18 GC LOW-NOISE PERMANENT-MAGNET TRAVELING-WAVE TUBE WITH INTEGRAL POWER SUPPLY

PERFORMANCE

	<u>Typical</u>	<u>Guaranteed</u>
Frequency	12 to 18 Gc	12 to 18 Gc
Noise figure, terminal	8 db	10 db max.
Gain, small signal	28 db	25 db min.
VSWR, input and output	1.5:1	2:1 max.
Power output	0 dbm	

ELECTRICAL REQUIREMENTS

	<u>Typical</u>	<u>Range</u> ¹
Primary voltage	115 v ac	115 ±10 v ac
Primary frequency	60 cps	48 to 420 cps
Primary power	20 w	

ENVIRONMENTAL CHARACTERISTICS²

Temperature	-54°C to +71°C
Vibration	
a) .10 inch, double amplitude	5 to 30 cps
b) 5 g, single amplitude	30 to 2000 cps
Shock	15 g, 11 ms

MECHANICAL CHARACTERISTICS

Amplifier length (excluding connectors)	12 inches, max.
Amplifier diameter	4.5 inches, nom.
Weight	18 pounds, max.
Primary power connection, Deutsch receptacle	DM9601-3P
RF connections	Waveguide Flange UG-541/U

1. Every tube will meet the guaranteed performance specifications for any voltage lying within these ranges.
2. These environmental characteristics meet or exceed the respective requirements of MIL-E-5400, Class 2.

WATKINS-JOHNSON COMPANY
Stanford Industrial Park
3333 Hillview Avenue
Palo Alto, California

Telephone: (415) 326-8830
Teletype: (910) 373-1253

September 1964



Vol. 8, No. 10; June, 1966

WJ-343

2.0 to 8.0 GHz LOW-NOISE, DOUBLE-OCTAVE, PERMANENT-MAGNET TRAVELING-WAVE TUBE AMPLIFIER WITH INTEGRAL POWER SUPPLY

The WJ-343 is the first of another new series of low-noise traveling-wave tube amplifiers developed by Watkins-Johnson Company. It makes available a double-octave bandwidth tube having a noise figure comparable to the single-octave C-band WJ-271. This capability, combined with a guaranteed power output of 0 dBm, makes the WJ-343 ideal for use in sensitive, ultra-wide-bandwidth receiver equipments.

The WJ-343 has the same long-life design, rugged construction and adjustment-free operation characteristic of Watkins-Johnson's line of octave-band, low-noise amplifiers. It has a typical noise figure of 6.0 dB, minimum small-signal gain of 25 dB, and typical small-signal-gain variation of ± 3 dB.



The WJ-343 amplifier may be mounted in any orientation, and is built to withstand the shock, vibration and temperature specifications of MIL-E-5400, Class 2. It is well shielded, permitting operation next to similar units or to ferromagnetic material,

without degradation of performance. The unit is 12 inches long, 4.75 inches in height and width, and weighs less than 18 pounds. Power input required is approximately 25 watts.

Details of electrical and mechanical characteristics are given on the attached specification sheet.

Additional information on the WJ-343 may be obtained through our representative in your area, or by contacting Watkins-Johnson Company, 3333 Hillview Avenue, Palo Alto, California. Inquiries to our Palo Alto facility should be addressed to the attention of Applications Engineering.

TENTATIVE SPECIFICATION

WJ-343

2.0 to 8.0 GHz LOW-NOISE, DOUBLE-OCTAVE, PERMANENT-MAGNET
TRAVELING-WAVE TUBE AMPLIFIER WITH INTEGRAL POWER SUPPLY

PERFORMANCE

	<u>Typical</u>	<u>Guaranteed</u>
Frequency	2.0 - 8.0 GHz	2.0 - 8.0 GHz
Noise figure, terminal	6.0 dB	7.0 dB max.
Gain, small signal	28 dB	25 dB
Gain variation, small signal	±3 dB	
VSWR, input and output	1.5:1	2.5:1 max.
Power output	+5 dBm	0 dBm

ELECTRICAL REQUIREMENTS

	<u>Typical</u>	<u>Range</u> ¹
Primary voltage	115 V ac	115 ± 10 V ac
Primary frequency	60 Hz	48 to 420 Hz
Primary power	25 watts	-

ENVIRONMENTAL CHARACTERISTICS²

Temperature	-54° to +71°C
Vibration	
a) 0.10 inch, double amplitude	5 to 45 Hz
b) 5 g, single amplitude	45 to 2000 Hz
Shock	15 g, 11 ms

MECHANICAL CHARACTERISTICS

Amplifier length (excluding connectors)	12 inches, max.
Amplifier height and width	4.75 inches, max.
Weight	18 lbs., max.
Primary power connection, Deutsch receptacle	DM9601-3P
RF connections	(50 ohms nominal) Type N, jack

¹ Every tube will meet the guaranteed performance specifications for any voltage within these ranges.

² These environmental characteristics meet or exceed the respective requirements for MIL-E-5400, Class 2.

WATKINS-JOHNSON COMPANY
Stanford Industrial Park
3333 Hillview Avenue
Palo Alto, California
Telephone: (415) 326-8830
Teletype: (910) 373-1253

June 1966

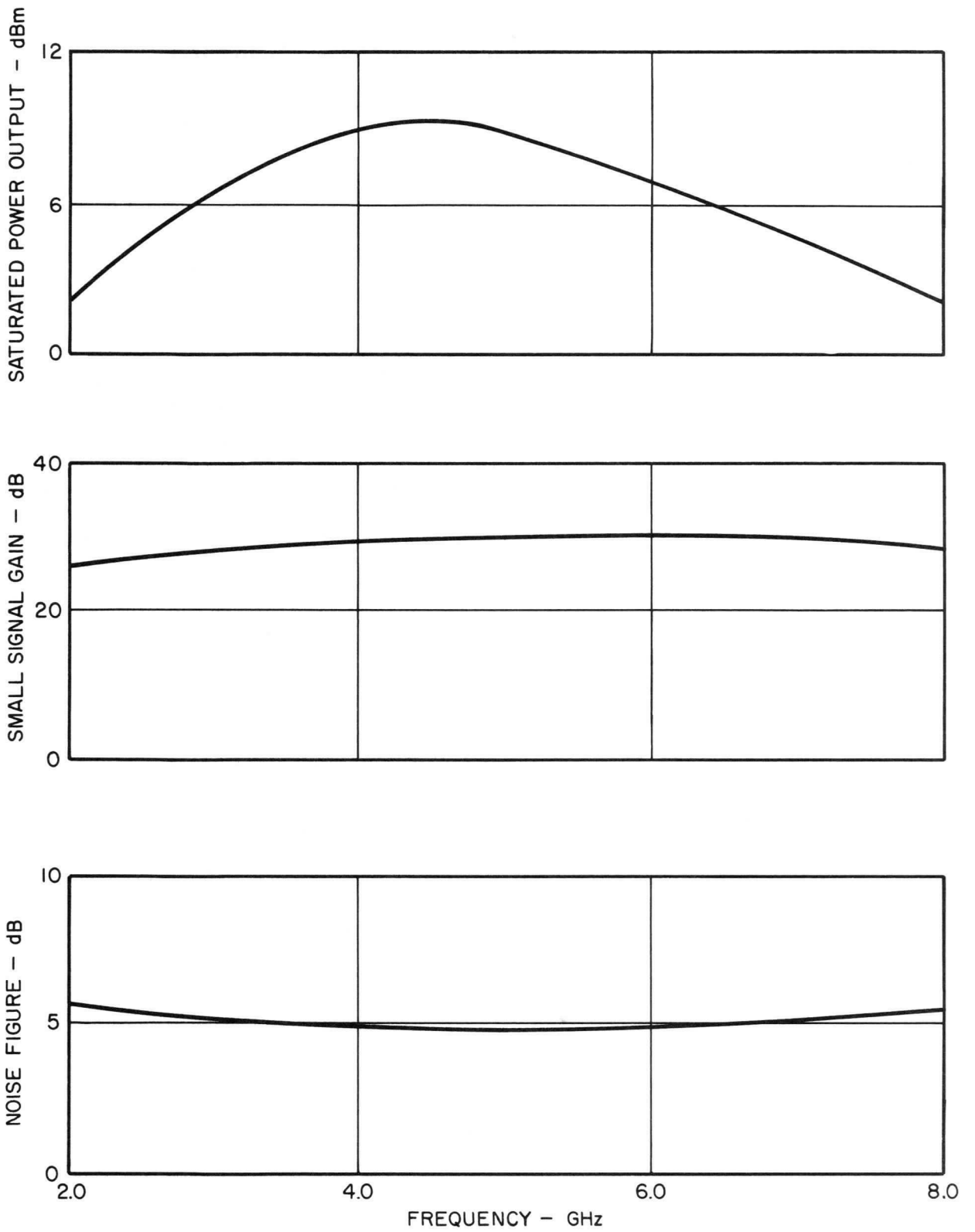

WJ-343 PERFORMANCE CHARACTERISTICS

"WJ" IDENTIFICATION LABEL

RF CONNECTOR
(2) REQ'D

FUSE 0.3 AMP 125 V

PILOT LIGHT

MOUNTING HOLE
1/4 - 20 UNC 28 0.38 DP
(4) PLACES

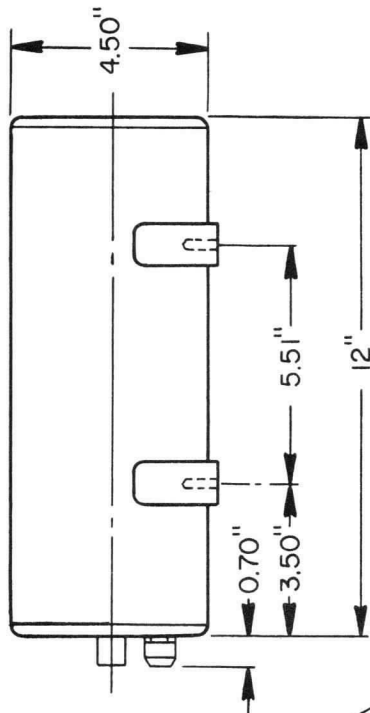
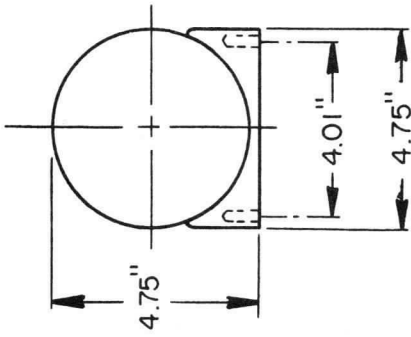



Vol. 8, No. 6; March 1966

WJ-349, WJ-349-2 and WJ-349-3

4.5 TO 6.5 GC LOW-NOISE PERMANENT-MAGNET
TRAVELING-WAVE-TUBE AMPLIFIERS WITH INTEGRAL POWER SUPPLY

The WJ-349 series of low-noise traveling-wave-tube amplifiers is an extension of the standard family of Watkins-Johnson TWT's. The new series provides exceptionally low noise figure through the center portion of the C-band, including the important bands of 4.5 to 5.0 Gc and 5.4 to 5.9 Gc. The WJ-349 family is identical in appearance to the WJ-271 octave-bandwidth C-band amplifier. It requires only an ac line-voltage input and is adjustment-free.

The WJ-349 amplifier package includes a shielded permanent-magnet that is not adversely affected by adjacent PM tubes or ferromagnetic material. Also integral with the package is a factory-set power supply whose total power consumption from the 115-volt ac source is less than 30 watts. All components are regulated or compensated for full specification performance from -54°C to $+85^{\circ}\text{C}$.

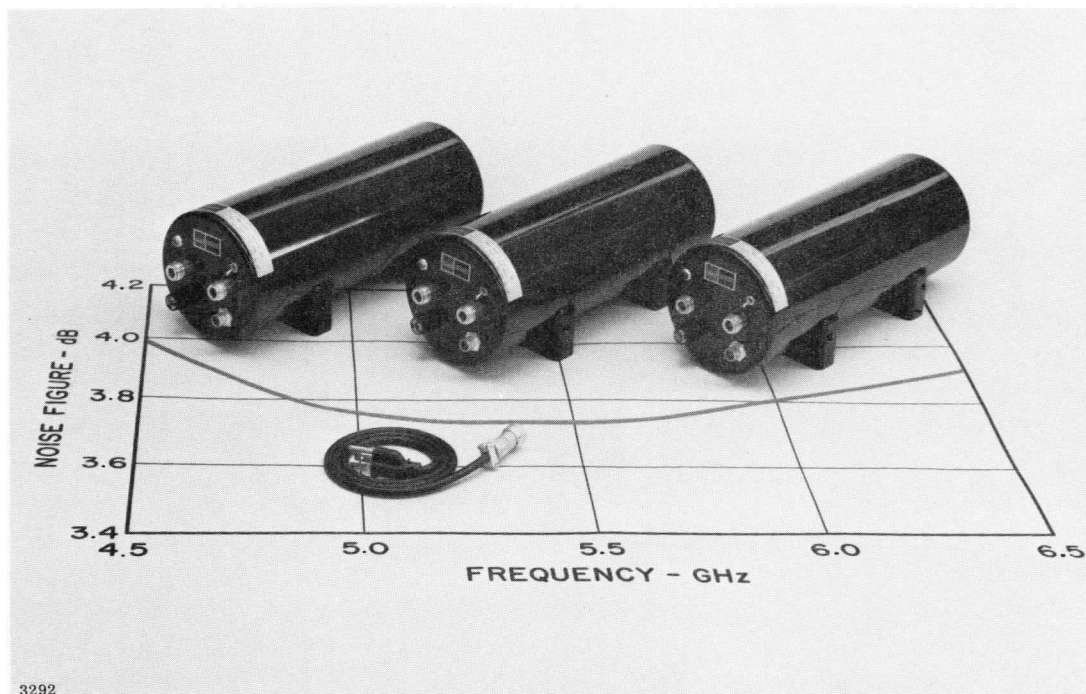

The weight of this amplifier is less than 17 pounds and it occupies a space, excluding connectors, of 12 inches long by 4.75 inches high.

The guaranteed maximum noise figure over the frequency range of 4.5 to 6.5 Gc is 5.0 dB. Small signal gain is 25 dB minimum and the saturated power output is nominally -3 dBm.

Installation and operation are simplified by the rugged construction of the WJ-349. When mounted in any orientation by its four threaded mounting holes, it can withstand vibrational forces of over 10 g at frequencies up to 2000 cps and shock in any plane of over 15 g, 11 millisecond duration. These environmental characteristics meet or exceed the corresponding requirements of MIL-E-5400, Class 2.

Conservative cathode loading and rigorous manufacturing process control assures the same long life in the WJ-349 as proven in other Watkins-Johnson low-noise tubes. Tubes of this design are exceeding operating life times of 15,000 hours.

Details of electrical and mechanical characteristics are given in the attached specification sheets. These include the WJ-349-2 which covers the band 4.5 to 5.0 Gc, and the WJ-349-3 designed for 5.4 to 5.9 Gc operation. Both these amplifiers have a maximum noise figure of 4.5 dB. Special units can be supplied having this low noise figure over any 0.5 Gc portion of the 4.5 to 6.5 Gc C-band.

Additional information may be obtained through our representative in your area, or by contacting Watkins-Johnson Company, 3333 Hillview Avenue, Palo Alto, California. Inquiries to our Palo Alto facility should be addressed to the attention of Applications Engineering.

TENTATIVE SPECIFICATION

WJ-349

4.5 - 6.5 GC, LOW-NOISE PERMANENT MAGNET TRAVELING-WAVE TUBE WITH INTEGRAL POWER SUPPLY

<u>PERFORMANCE</u>	<u>Typical</u>	<u>Guaranteed</u>
Frequency	4.5 - 6.5 Gc	4.5 - 6.5 Gc
Noise figure, terminal	4.5 dB	5.0 dB max.
Gain, small signal	30 dB	25 dB min.
VSWR, input and output	1.5:1	2:1 max.
Power output	-3.0 dBm	

<u>ELECTRICAL REQUIREMENTS</u>	<u>Typical</u>	<u>Range</u> ¹
Primary voltage	115 v ac	115 ± 10 v ac
Primary frequency	60 cps	48 to 420 cps
Primary power	25 watts	

<u>ENVIRONMENTAL CHARACTERISTICS</u> ²	
Temperature	-54°C to +85°C
Vibration	
a) .10 inch, double amplitude	5 to 45 cps
b) 10 g, single amplitude	45 to 2000 cps
Shock	15 g, 11 ms

<u>MECHANICAL CHARACTERISTICS</u>	
Amplifier length (excluding connectors)	12.0 inches, max.
Amplifier height and width	4.75 inches, max.
Weight	17 pounds, max.
Primary power connection, Deutsch receptacle	DM9601-3P
RF connections (50 ohms, nominal)	Type N, jack

1. Every tube will meet the guaranteed performance specifications for any voltage lying within these ranges.
2. These environmental characteristics meet or exceed the respective requirements of MIL-E-5400, Class 2.

WATKINS-JOHNSON COMPANY
Stanford Industrial Park
3333 Hillview Avenue
Palo Alto, California

Telephone: (415) 326-8830
Teletype: (910) 373-1253

March 1966

TENTATIVE SPECIFICATION

WJ-349-2

4.5 - 5.0 GC, LOW-NOISE PERMANENT MAGNET TRAVELING-WAVE TUBE WITH INTEGRAL POWER SUPPLY

<u>PERFORMANCE</u>	<u>Typical</u>	<u>Guaranteed</u>
Frequency	4.5 - 5.0 Gc	4.5 - 5.0 Gc
Noise figure, terminal	4.0 dB	4.5 dB max.
Gain, small signal	30 dB	25 dB min.
VSWR, input and output	1.5:1	2:1 max.
Power output	-3.0 dBm	

<u>ELECTRICAL REQUIREMENTS</u>	<u>Typical</u>	<u>Range</u> ¹
Primary voltage	115 V ac	115 ± 10 V ac
Primary frequency	60 cps	48 to 420 cps
Primary power	25 watts	

ENVIRONMENTAL CHARACTERISTICS²

Temperature	-54°C to +85°C
Vibration	
a) .10 inch, double amplitude	5 to 45 cps
b) 10 g, single amplitude	45 to 2000 cps
Shock	15 g, 11 ms

MECHANICAL CHARACTERISTICS

Amplifier length (excluding connectors)	12.0 inches, max.
Amplifier height and width	4.75 inches, max.
Weight	17 pounds, max.
Primary power connection, Deutsch receptacle	DM9601-3P
RF connections (50 ohms, nominal)	Type N, jack

1. Every tube will meet the guaranteed performance specifications for any voltage lying within these ranges.
2. These environmental characteristics meet or exceed the respective requirements of MIL-E-5400, Class 2.

WATKINS-JOHNSON COMPANY
Stanford Industrial Park
3333 Hillview Avenue
Palo Alto, California

Telephone: (415) 326-8830
Teletype: (910) 373-1253

March 1966

TENTATIVE SPECIFICATION

WJ-349-3

5.4 - 5.9 GC, LOW-NOISE PERMANENT MAGNET TRAVELING-WAVE TUBE WITH INTEGRAL POWER SUPPLY

<u>PERFORMANCE</u>	<u>Typical</u>	<u>Guaranteed</u>
Frequency	5.4 - 5.9 Gc	5.4 - 5.9 Gc
Noise figure, terminal	4.0 dB	4.5 dB max.
Gain, small signal	30 dB	25 dB min.
VSWR, input and output	1.5:1	2:1 max.
Power output	-3.0 dBm	

<u>ELECTRICAL REQUIREMENTS</u>	<u>Typical</u>	<u>Range</u> ¹
Primary voltage	115 V ac	115 ± 10 V ac
Primary frequency	60 cps	48 to 420 cps
Primary power	25 watts	

<u>ENVIRONMENTAL CHARACTERISTICS</u> ²	
Temperature	-54°C to +85°C
Vibration	
a) .10 inch, double amplitude	5 to 45 cps
b) 10 g, single amplitude	45 to 2000 cps
Shock	15 g, 11 ms

<u>MECHANICAL CHARACTERISTICS</u>	
Amplifier length (excluding connectors)	12.0 inches, max.
Amplifier height and width	4.75 inches, max.
Weight	17 pounds, max.
Primary power connection, Deutsch receptacle	DM9601-3P
RF connections (50 ohms, nominal)	Type N, jack

1. Every tube will meet the guaranteed performance specifications for any voltage lying within these ranges.
2. These environmental characteristics meet or exceed the respective requirements of MIL-E-5400, Class 2.

WATKINS-JOHNSON COMPANY
Stanford Industrial Park
3333 Hillyview Avenue
Palo Alto, California

Telephone: (415) 326-8830
Teletype: (910) 373-1253

March 1966

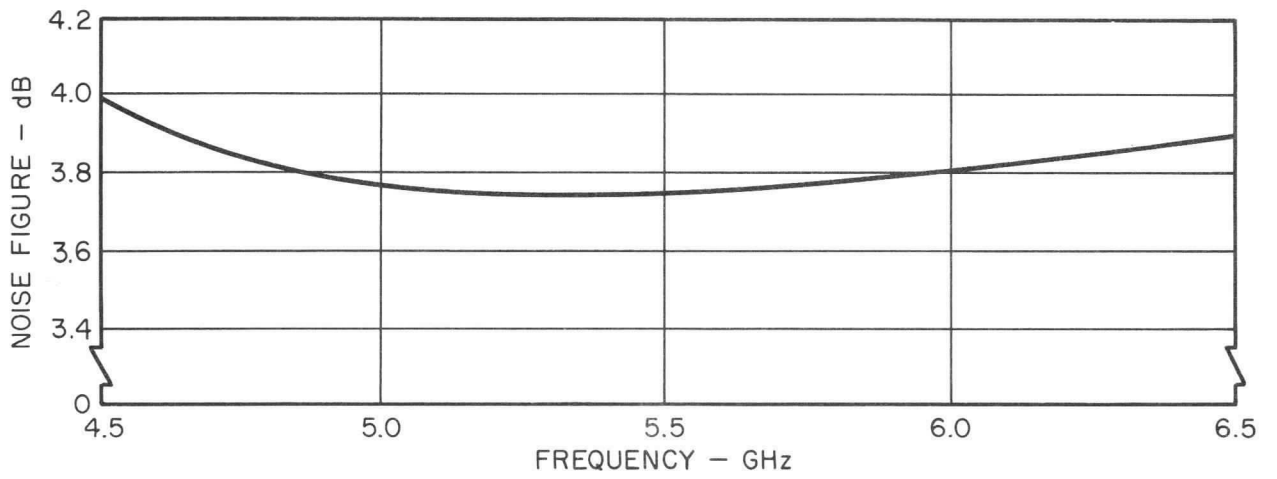
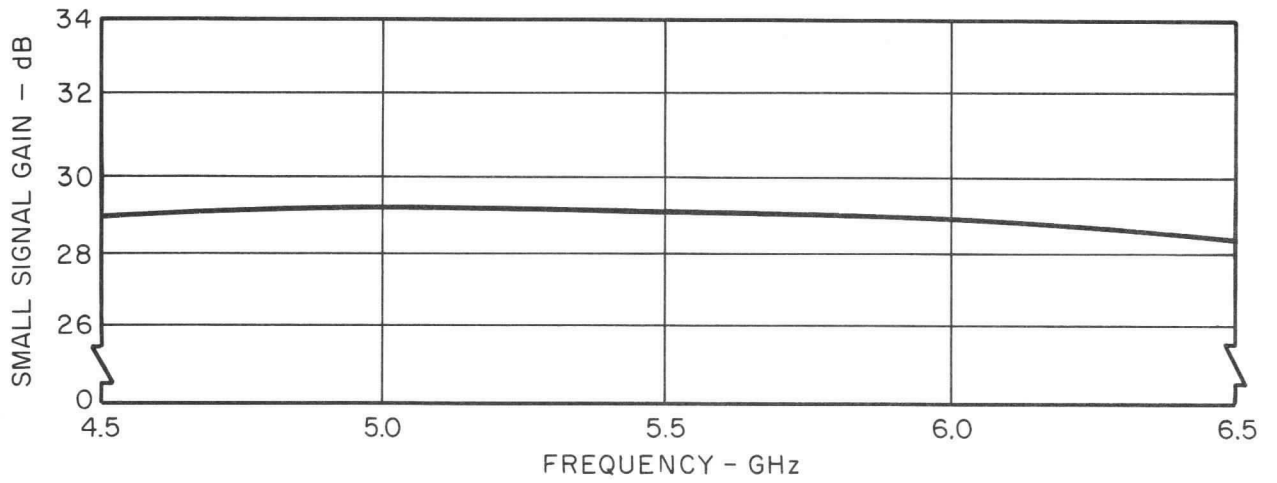
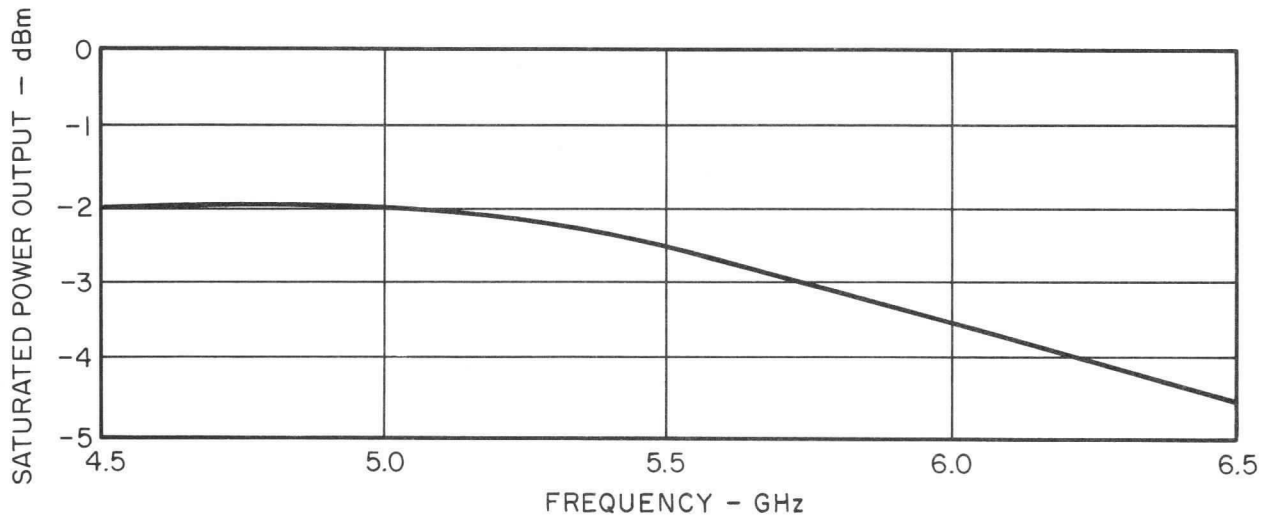

WJ-349 PERFORMANCE CHARACTERISTICS

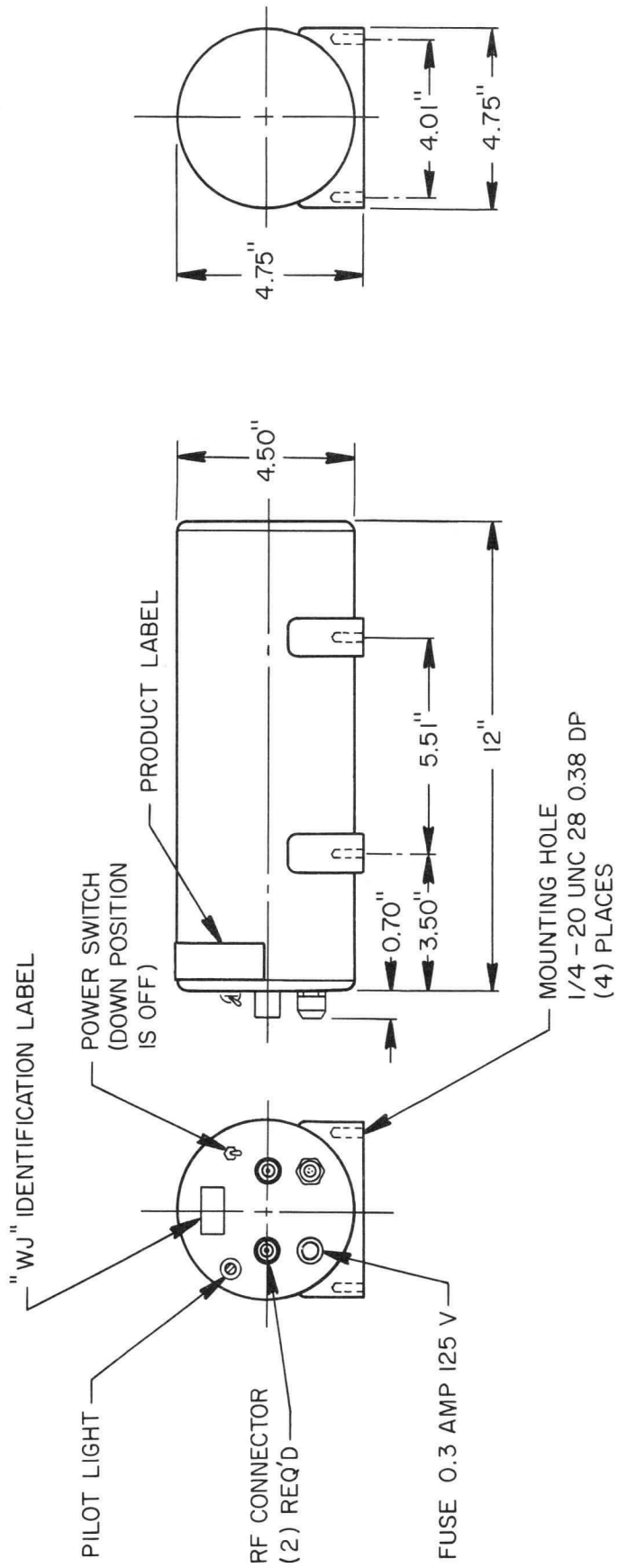

FIGURE 2. WJ-349 OUTLINE DRAWING.



Vol. 7, No. 8, December 1965

WJ-353

2 TO 4 GC LOW-NOISE PERMANENT MAGNET TRAVELING-WAVE-TUBE AMPLIFIER WITH BATTERY-OPERATED INTEGRAL POWER SUPPLY

The WJ-353 is the first in a new series of low-noise traveling-wave-tube amplifiers by Watkins-Johnson Company. It presents a totally new concept in TWT amplifiers in its ability to operate with less than one watt input power. This capability, combined with its light weight and compact size, makes it ideal for use where the proven reliability and performance of the TWT are needed, yet where power must be economized. The WJ-353 is similar in physical and performance characteristics to the WJ-295, and is completely self-contained and adjustment-free.

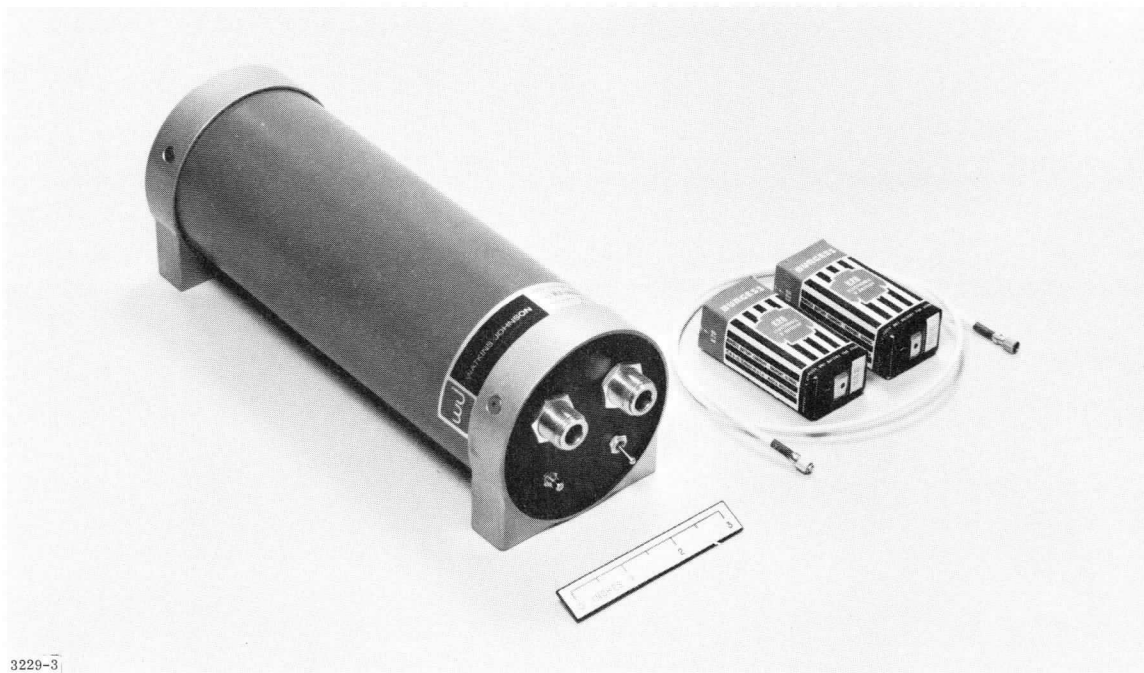

This new member of the well-known Watkins-Johnson low-noise family has a typical noise figure of 8.0 dB, and can be operated adjacent to similar units without degradation of performance. It weighs less than 5.0 pounds, is 9.5 inches long (excluding Type N connectors), and measures 3.4 inches in height and width. It operates from dc voltage between 22 and 30 volts, with a typical power drain of 600 milliwatts. Although the WJ-353 can be operated from a small dry-cell battery pack (the batteries in the photograph provided over 11 hours of continuous operation), an optional WJ-915 silver-cadmium battery pack is available which will provide up to 200 hours of operation. The WJ-915 occupies a volume of approximately 170 cubic inches and weighs less than 9 pounds.

The WJ-353 may be mounted in any orientation, and is built to withstand vibration and extremes of temperature. Details of electrical and mechanical characteristics are given on the attached specification sheet.

Additional information may be obtained through our representative in your area, or by contacting Watkins-Johnson Company, 3333 Hillview Avenue, Palo Alto, California. Inquiries to our Palo Alto facility should be addressed to the attention of Applications Engineering.

TENTATIVE SPECIFICATION

WJ-353

2 TO 4 GC LOW-NOISE PERMANENT MAGNET TRAVELING-WAVE-TUBE AMPLIFIER WITH BATTERY-OPERATED INTEGRAL POWER SUPPLY

<u>PERFORMANCE</u>	<u>Typical</u>	<u>Guaranteed</u>
Frequency	2.0 - 4.0 Gc	2.0 - 4.0 Gc
Noise figure	8.0 dB	9.0 dB, max.
Gain, small signal	28 dB	25 dB, min.
VSWR, input and output	1.5:1	2:1, max.
Power output	+6 dBm	

<u>ELECTRICAL REQUIREMENTS</u>	<u>Typical</u>	<u>Range</u> ¹
Primary voltage	26 V dc	26 ± 4 V dc
Primary power	0.6 watt	1.0 watt, max.

<u>ENVIRONMENTAL CHARACTERISTICS</u> ²	
Temperature	-54° to +85°C
Vibration	
a) 0.10 inch, double amplitude	5 to 45 cps
b) 10 g, single amplitude	45 to 2,000 cps
Shock	15 g, 11 ms

<u>MECHANICAL CHARACTERISTICS</u>	
Amplifier length, excluding connectors	9.5 inches, max.
Amplifier height and width	3.4 inches, max.
Weight	5.0 lbs, max.
Primary power connection, Amphenol Subminax	Type 27, jack
RF connections (50 ohms, nominal)	Type N, jack

1. Every tube will meet the guaranteed performance specifications for any voltage lying within these ranges.
2. These environmental characteristics meet or exceed the corresponding requirements for MIL-E-5400, Class 2.

WATKINS-JOHNSON COMPANY
Stanford Industrial Park
3333 Hillview Avenue
Palo Alto, California

Telephone: (415) 326-8830
Teletype: (910) 373-1253

1 December 1965

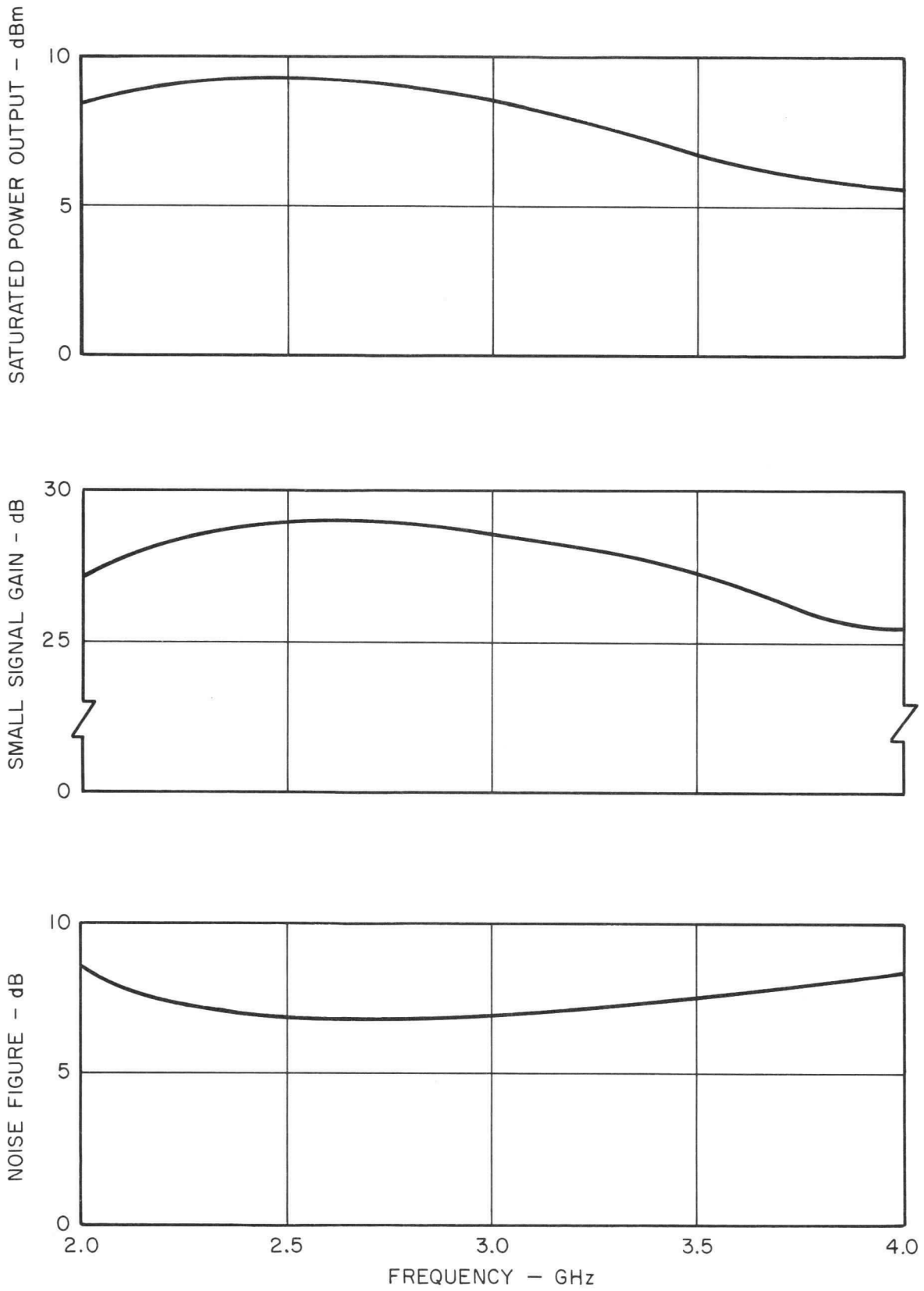

TYPICAL CHARACTERISTICS OF THE WJ-353.

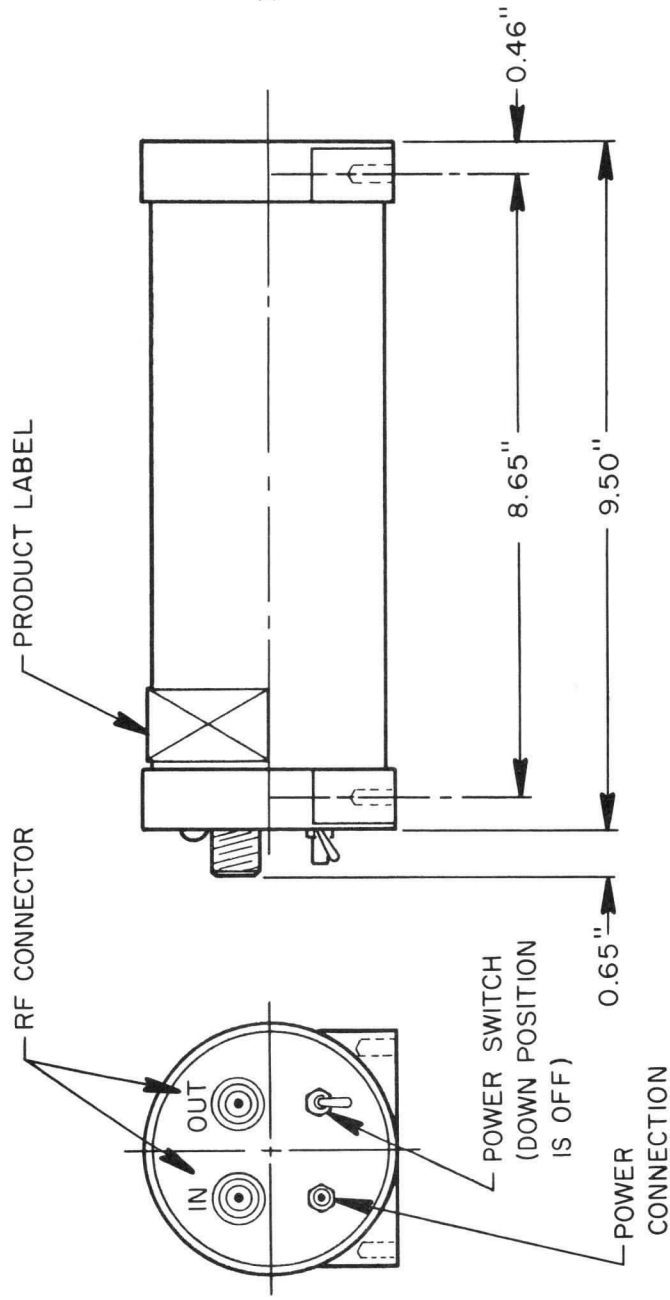
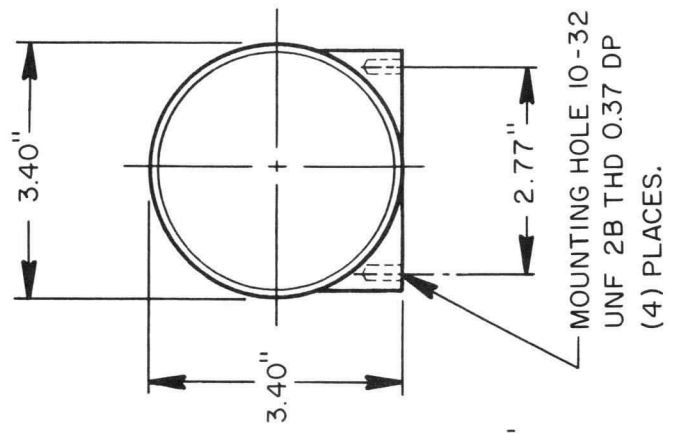

OUTLINE DRAWING OF THE WJ - 353.



Vol. 8, No. 4, January 1966

WJ-355

2.2 TO 2.3 GHz LOW-NOISE PERMANENT-MAGNET TRAVELING-WAVE-TUBE AMPLIFIER WITH INTEGRAL POWER SUPPLY

Designed especially for space communication and telemetry applications, the WJ-355 exhibits one of the lowest noise figures of any traveling-wave-tube amplifier currently available in a completely packaged unit. Although guaranteed not to exceed 3.7 dB, the WJ-355 typically produces less than 3.4 dB noise across the major portion of the 2.2 to 2.3 GHz spectrum for which it is designed to operate. (See attached performance curves.) This new tube, like most Watkins-Johnson low-noise TWT amplifiers, comes in a single package complete with its own integral 115 volt ac power supply

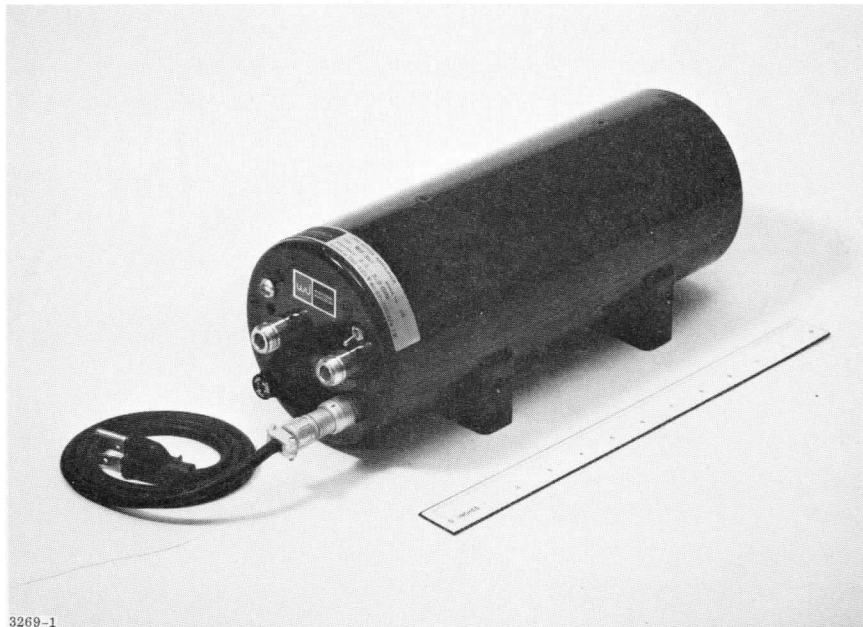

To afford maximum flexibility, the power supply operates equally well from commercial 60 Hz power or from 400 Hz power characteristically available in aircraft. Total power consumption of the amplifier is less than 30 watts.

The WJ-355 is packaged in the standard Watkins-Johnson low-noise tube drip-proof cylindrical housing measuring 12 inches in length and 4.75 inches in cross section (the actual cylinder is 4.5 inches in diameter - mounting feet adding another 0.25 inch. See attached outline drawing.) The housing provides magnetic shielding which permits operation of these, or similar units, in stacked arrays or adjacent to ferromagnetic material without affecting amplifier performance.

This is a ready-to-operate TWT amplifier. No adjustments are required upon receipt, nor are readjustments required during the amplifier's long life. Other low-noise units, similar to the WJ-355, are attaining MTBF's in excess of 18,000 hours with a 99 percent confidence level. This long life, which gives the WJ-355 an extremely low cost per operating hour, is a result of the advanced design and careful processing techniques for which Watkins-Johnson Company is noted.

The amplifier may be mounted in any orientation without degradation of performance. Rugged construction of the tube, magnet, and power supply assembly assures reliable operation under vibrational forces of 10 g, at frequencies up to 2000 Hz. Full specifications are met over the operating temperature range of -54° to $+85^{\circ}$ C. The environmental characteristics of the WJ-355 meet or exceed the corresponding requirements of MIL-E-5400G, Class 2.

Details of electrical and mechanical characteristics are given on the attached specification sheet.

Additional information on the WJ-355 may be obtained through our representative in your area, or by contacting Watkins-Johnson Company, 3333 Hillview Avenue, Palo Alto, California. Inquiries to our Palo Alto facility should be addressed to the attention of Applications Engineering.

TENTATIVE SPECIFICATION

WJ-355, 2.2 - 2.3 GHz LOW-NOISE PERMANENT-MAGNET TRAVELING-WAVE TUBE WITH INTEGRAL POWER SUPPLY

<u>PERFORMANCE</u>	<u>Typical</u>	<u>Guaranteed</u>
Frequency	2.2-2.3 GHz	2.2-2.3 GHz
Noise figure, terminal	3.4 dB	3.7 dB max.
Gain, small signal	28 dB	25 dB min.
VSWR, input and output	1.5:1	2:1 max.
Power output	-5.0 dBm	

<u>ELECTRICAL REQUIREMENTS</u>	<u>Typical</u>	<u>Range</u> ¹
Primary voltage	115 V ac	115 ± 10 V ac
Primary frequency	60 Hz	48 to 420 Hz
Primary power	30 watts	

<u>ENVIRONMENTAL CHARACTERISTICS</u> ²	
Temperature	-54°C to +71°C
Vibration	
a) .10 inch, double amplitude	5 to 45 Hz
b) 10 g, single amplitude	45 to 2000 Hz
Shock	15 g, 11 ms

<u>MECHANICAL CHARACTERISTICS</u>	
Amplifier length (excluding connectors)	12 inches, max.
Amplifier height and width	4.75 inches, max.
Weight	17 pounds
Primary power connection, Deutsch receptacle	DM 9601-3P
RF connections (50 ohms, nominal)	Type N, jack

1. Every tube will meet the guaranteed performance specifications for any voltage lying within these ranges.
2. These environmental characteristics meet or exceed the respective requirements of MIL-E-5400, Class 2.

Watkins-Johnson Company
Stanford Industrial Park
3333 Hillview Avenue
Palo Alto, California

Telephone: (415) 326-8830
Teletype: (910) 373-1253

January 1966

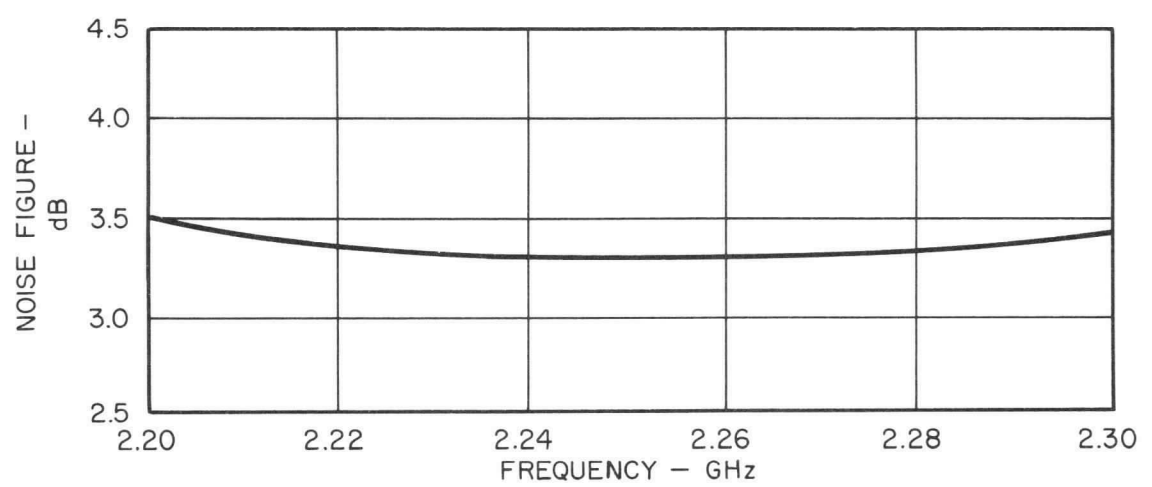
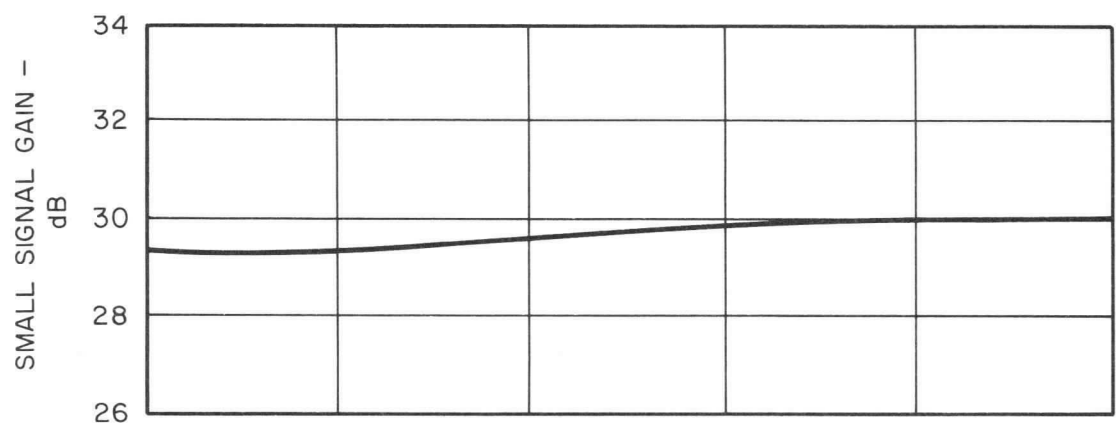
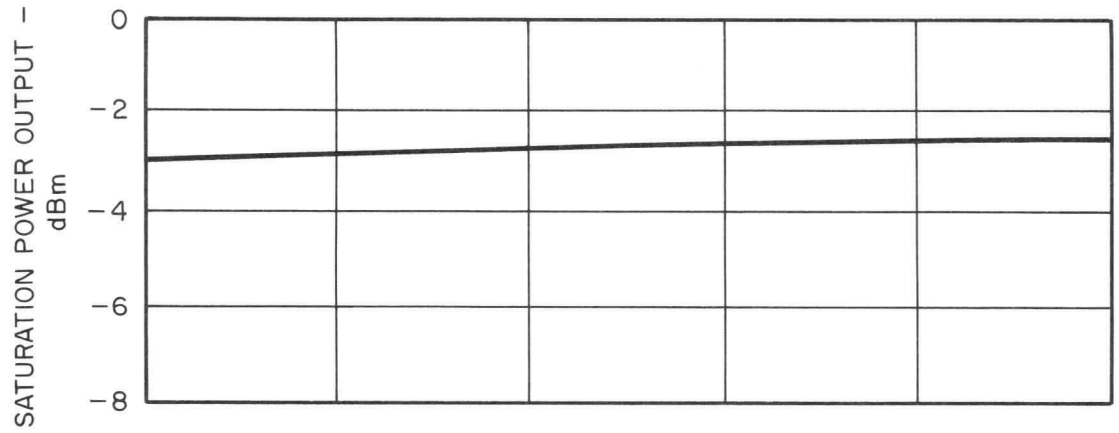

PERFORMANCE CHARACTERISTICS OF THE WJ - 355

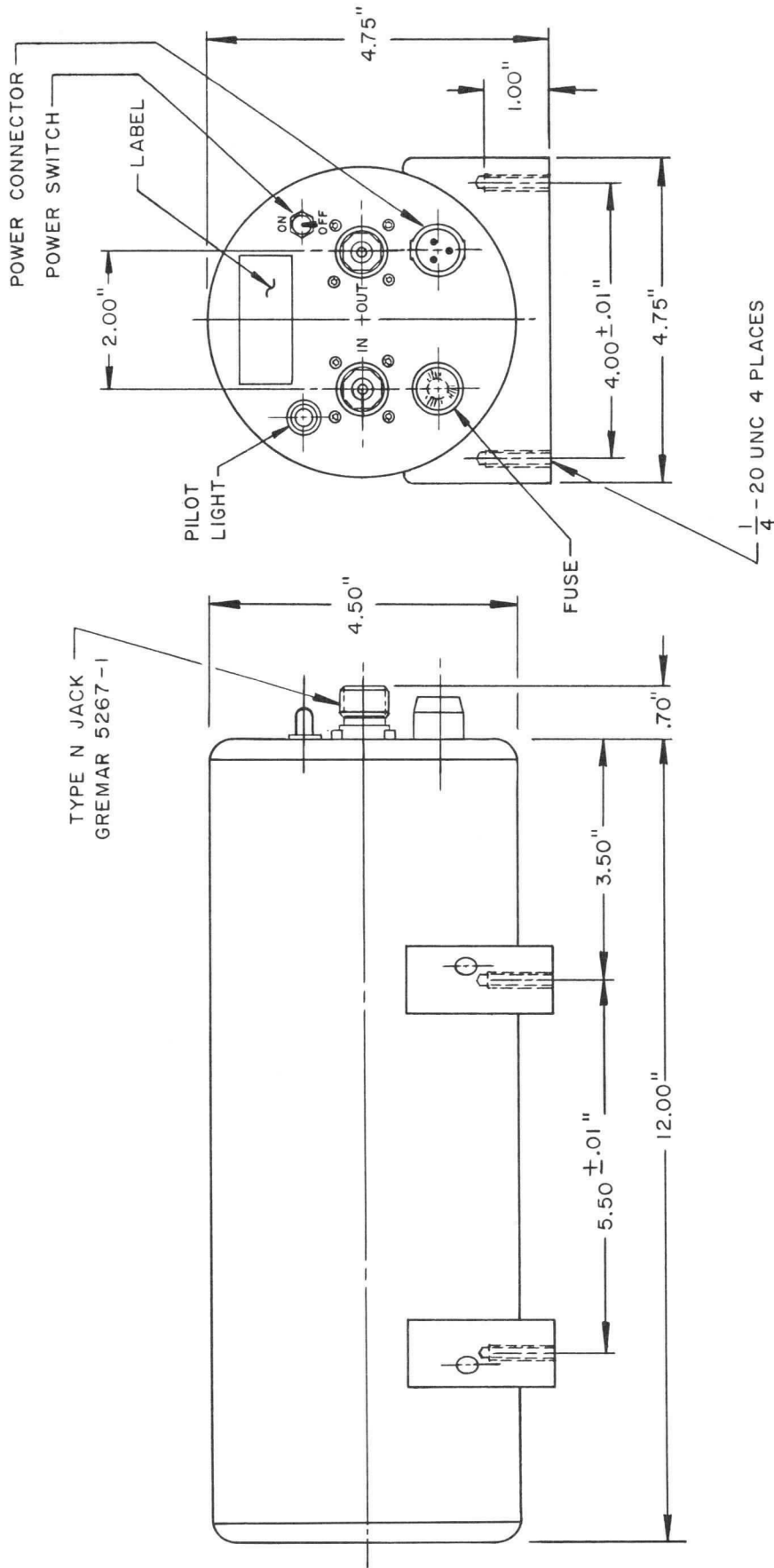

POWER CONNECTIONS	
DEUTSCH DM9601-3P	
PIN	CONNECTION
1	115 VAC
2	GROUND
3	115 VAC

OUTLINE DRAWING OF THE WJ-355



Vol. 8, No. 7; March, 1966

WJ-363

8 TO 12 GHZ, 20 MILLIWATT LOW-NOISE PERMANENT-MAGNET
TRAVELING-WAVE TUBE AMPLIFIER WITH INTEGRAL POWER
SUPPLY

With the addition of the WJ-363 to its family of PM-focused integral power supply amplifiers, Watkins-Johnson Company increases the dynamic range of its X-Band low-noise amplifiers. Like its lower-power predecessors, the WJ-363 is completely self-contained, adjustment-free, and operates with only an ac line voltage input.

This 20 milliwatt version of the Watkins-Johnson low-noise family has a typical noise figure of 8 dB, and can be operated next to similar units or in the vicinity of ferromagnetic materials without degradation of performance. It weighs less than 18 pounds, and measures 12 inches in length (less connectors) by 4.5 inches in diameter. Power drain from the 115-volt ac source is less than 30 watts.

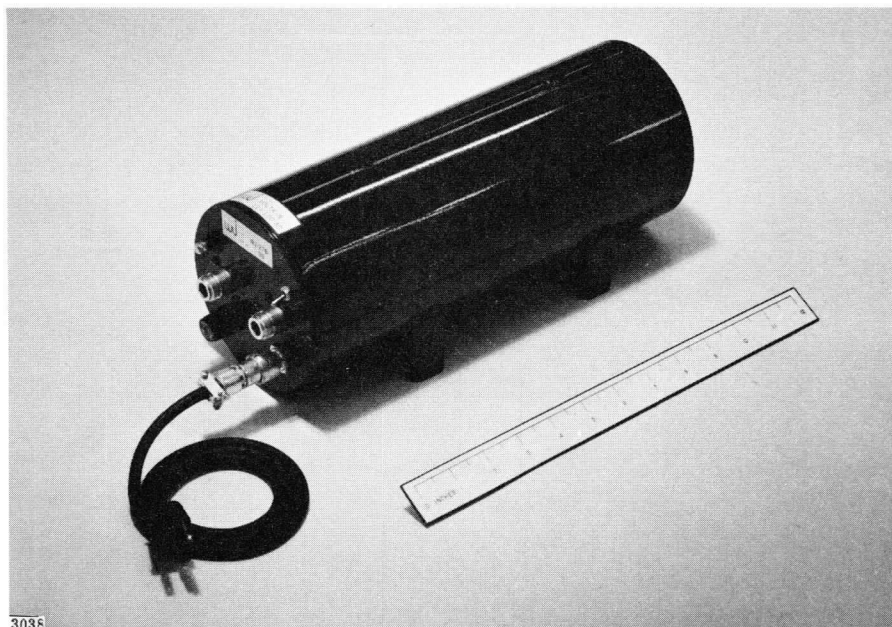

The WJ-363 offers a guaranteed maximum noise figure of 10 dB over the frequency range 8 to 12 GHz. Small-signal gain is 30 dB minimum, and saturated power output is 13 dBm minimum.

The tube may be mounted in any orientation without degradation of performance. Rugged construction of the tube, magnet, and power supply assembly assures reliable operation under vibrational forces of 5 g, at frequencies up to 2,000 Hz. Full specifications are met over the operating temperature range of -54° to $+71^{\circ}\text{C}$. The environmental characteristics of the WJ-363 meet or exceed the corresponding requirements of MIL-E-5400, Class 2.

The same conservative design and careful processing techniques which have given long life in other Watkins-Johnson low-noise tubes have been extended to this new member of the permanent-magnet focused family.

Details of electrical and mechanical characteristics are given on the attached tentative specification sheet.

Additional information about the WJ-363 may be obtained through our representative in your area, or by contacting Watkins-Johnson Company, 3333 Hillview Avenue, Palo Alto, California. Inquiries to our Palo Alto facility should be addressed to the attention of Applications Engineering.

TENTATIVE SPECIFICATION

WJ-363

8 TO 12 GHZ, 20 MILLIWATT LOW-NOISE PERMANENT-MAGNET
TRAVELING-WAVE TUBE WITH INTEGRAL POWER SUPPLY

PERFORMANCE

	<u>Typical</u>	<u>Guaranteed</u>
Frequency	8 to 12 GHz	8 to 12 GHz
Noise figure, terminal	8 dB	10 dB max.
Gain, small signal	35 dB	30 dB min.
VSWR, input and output	1.5:1	2:1 max
Power output	16 dBm	13 dBm

ELECTRICAL REQUIREMENTS

	<u>Typical</u>	<u>Range</u> ¹
Primary voltage	115 V ac	115 ± 10 V ac
Primary frequency	60 Hz	48 to 420 Hz
Primary power	20 W	

ENVIRONMENTAL CHARACTERISTICS²

Temperature	-54°C to +71°C
Vibration	
a) .10 inch, double amplitude	5 to 30 Hz
b) 5 g, single amplitude	30 to 2000 Hz
Shock	15 g, 11 ms

MECHANICAL CHARACTERISTICS

Amplifier length (excluding connectors)	12 inches, max.
Amplifier diameter	4.5 inches, nom.
Weight	18 pounds, max.
Primary power connection, Deutsch receptacle	DM9601-3P

1. Every tube will meet the guaranteed performance specifications for any voltage lying within these ranges.
2. These environmental characteristics meet or exceed the respective requirements of MIL-E-5400, Class 2.

WATKINS-JOHNSON COMPANY
Stanford Industrial Park
3333 Hillview Avenue
Palo, Alto, California
Telephone: (415) 326-8830
Teletype: (910) 373-1253

March 1966

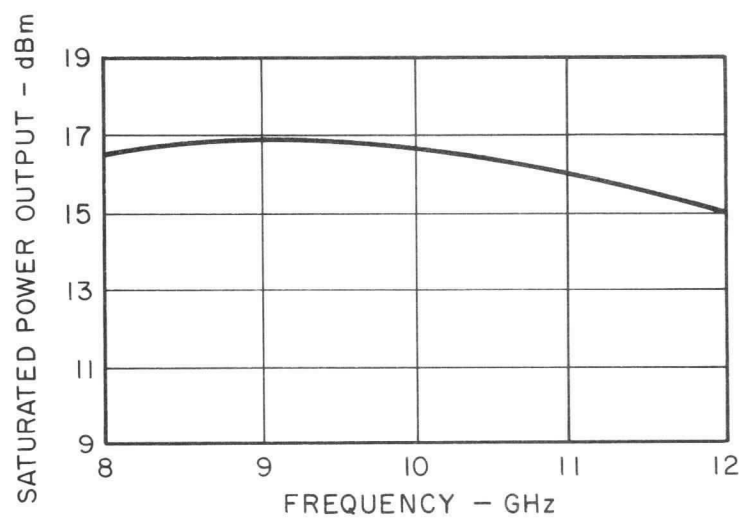
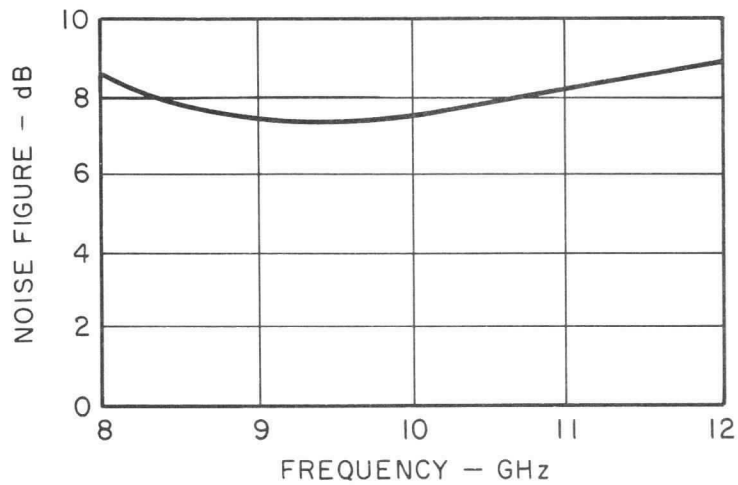
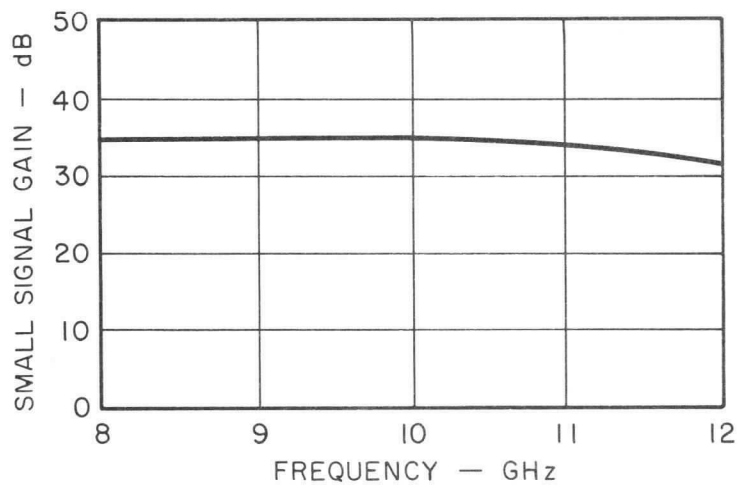

TYPICAL PERFORMANCE CHARACTERISTICS OF THE WJ - 363

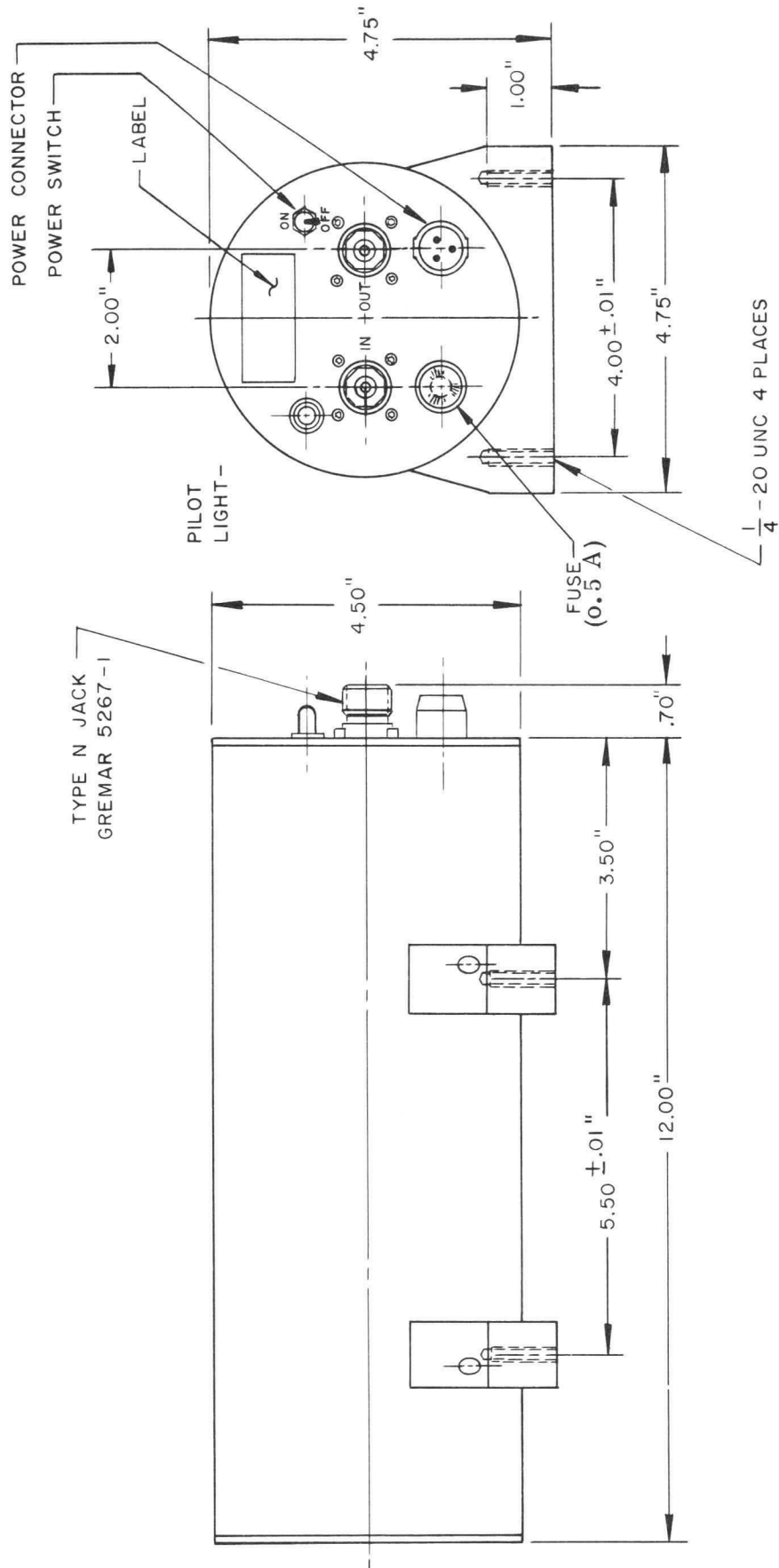

POWER CONNECTIONS	
DEUTSCH DM9601-3P	
PIN	CONNECTION
1	115 VAC
2	GROUND
3	115 VAC



Vol. 8, No. 8; May, 1966

WJ-384

8 TO 12 GHz, 10 MILLIWATT LOW-NOISE PERMANENT-MAGNET
TRAVELING-WAVE-TUBE AMPLIFIER WITH INTEGRAL POWER
SUPPLY

This is Watkins-Johnson's newest addition to the X-band family - a 10 milliwatt traveling-wave-tube amplifier that exhibits the same low noise figure of the well-known WJ-276, but with much higher saturated power output. The WJ-384 offers a guaranteed maximum noise figure of 8.5 dB over the 8.0 to 12.0 GHz frequency range, but typically can be expected to yield a noise figure of less than 7.5 dB over much of this range. Saturated power output is +10 dB minimum, and small-signal gain is 25 dB minimum.

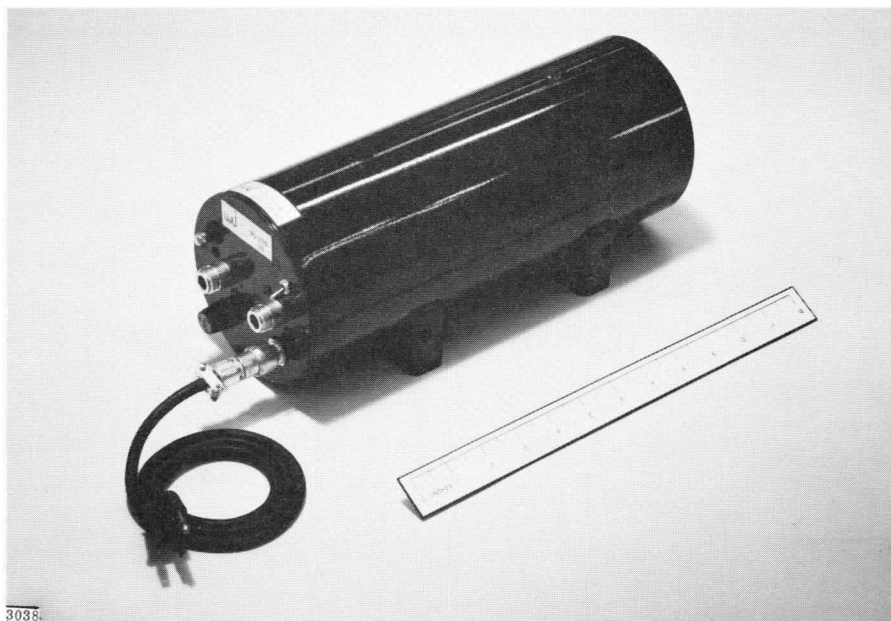

Like other low-noise units from Watkins-Johnson, the WJ-384 has its own integral, adjustment-free power supply designed to operate from any 115 volt, 48 to 420 Hz power source. It may be operated in any orientation, next to similar units, or in the vicinity of ferromagnetic materials without degradation of performance. Rugged construction of tube, magnet, and power supply assembly assured reliable operation under environmental conditions paralleled by those specified in MIL-E-5400 for Class 2 equipment.

The same conservative design and careful processing techniques which have given long life in other Watkins-Johnson low-noise amplifiers have been extended to this new member of the X-band family. With similar types of units attaining MTBF's in excess of 15,000 hours (99% confidence level), the WJ-384 can be expected to yield the same low cost per operating hour characteristic of other Watkins-Johnson low-noise amplifiers.

Details of electrical and mechanical characteristics are given on the attached tentative specification, performance curve and outline sheets. Additional information about the WJ-384 may be obtained through our representative in your area, or by contacting Watkins-Johnson Company, 3333 Hillview Avenue, Palo Alto, California. Inquiries to our Palo Alto facility should be addressed to the attention of Applications Engineering.

TENTATIVE SPECIFICATION

WJ-384

8 TO 12 GHz, 10 MILLIWATT LOW-NOISE PERMANENT-MAGNET TRAVELING-WAVE TUBE WITH INTEGRAL POWER SUPPLY

<u>PERFORMANCE</u>	<u>Typical</u>	<u>Guaranteed</u>
Frequency	8 to 12 GHz	8 to 12 GHz
Noise figure, terminal	7.5 dB	8.5 dB, max.
Gain, small signal	30 dB	25 dB, min
VSWR, input and output	1.5:1	2:1 max
Power output	+13 dBm	+10 dBm

<u>ELECTRICAL REQUIREMENTS</u>	<u>Typical</u>	<u>Range¹</u>
Primary voltage	115 V ac	115 ± 10 V ac
Primary frequency	60 Hz	48 to 420 Hz
Primary power	20 W	

ENVIRONMENTAL CHARACTERISTICS²

Temperature	-54°C to +71°C
Vibration	
a) .10 inch, double amplitude	5 to 30 Hz
b) 5 g, single amplitude	30 to 2000 Hz
Shock	15 g, 11 ms

MECHANICAL CHARACTERISTICS

Amplifier length (excluding connectors)	12 inches, max.
Amplifier diameter	4.5 inches, nom.
Weight	18 pounds, max.
Primary power connection, Deutsch receptacle	DM9601-3P

1. Every tube will meet the guaranteed performance specifications for any voltage lying within these ranges.
2. These environmental characteristics meet or exceed the respective requirements of MIL-E-5400, Class 2.

WATKINS-JOHNSON COMPANY

Stanford Industrial Park

3333 Hillview Avenue

Palo Alto, California

Telephone: (415) 326-8830

Teletype: (910) 373-1253

May 1966

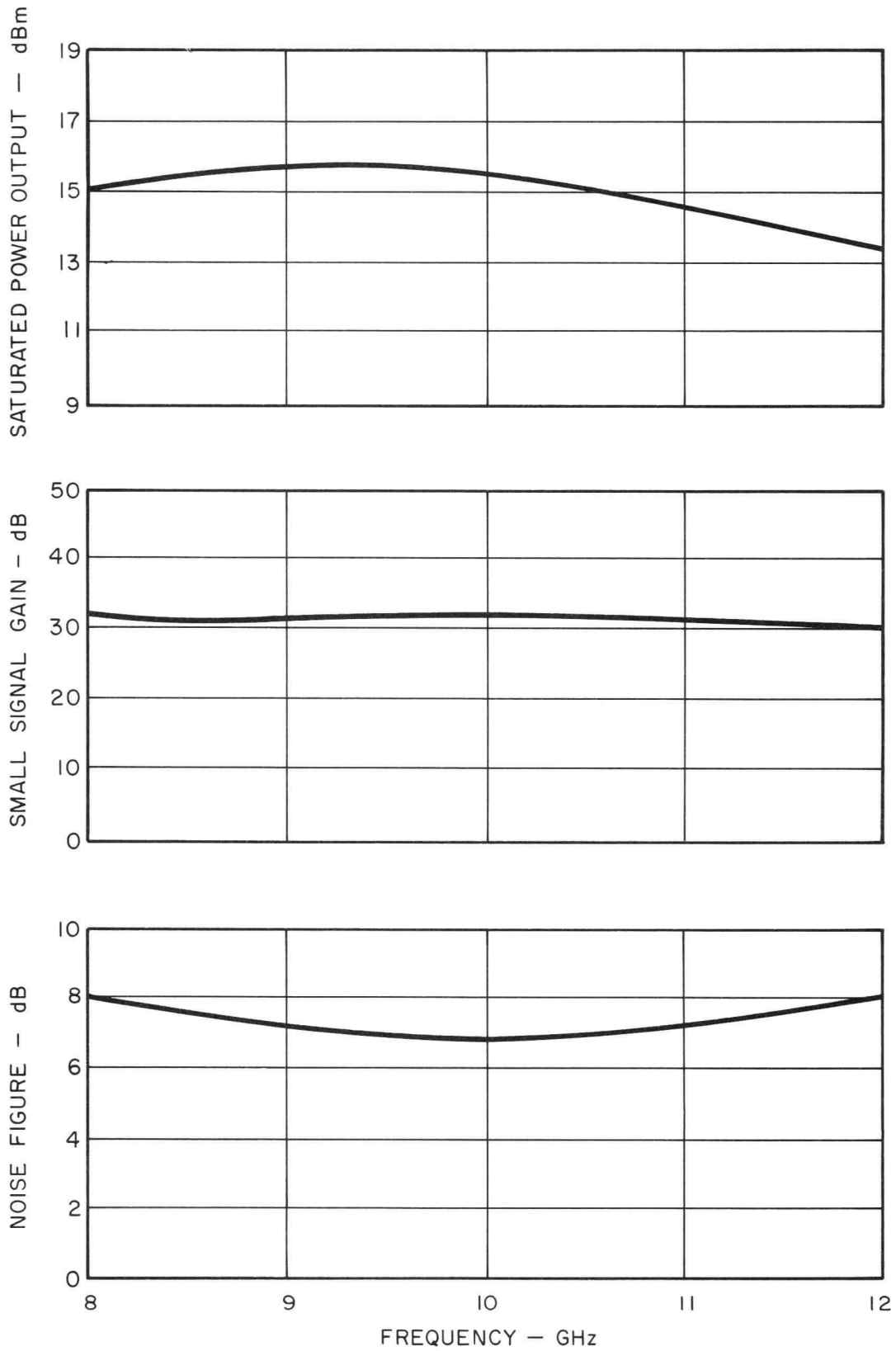

TYPICAL PERFORMANCE CHARACTERISTICS OF THE WJ-384

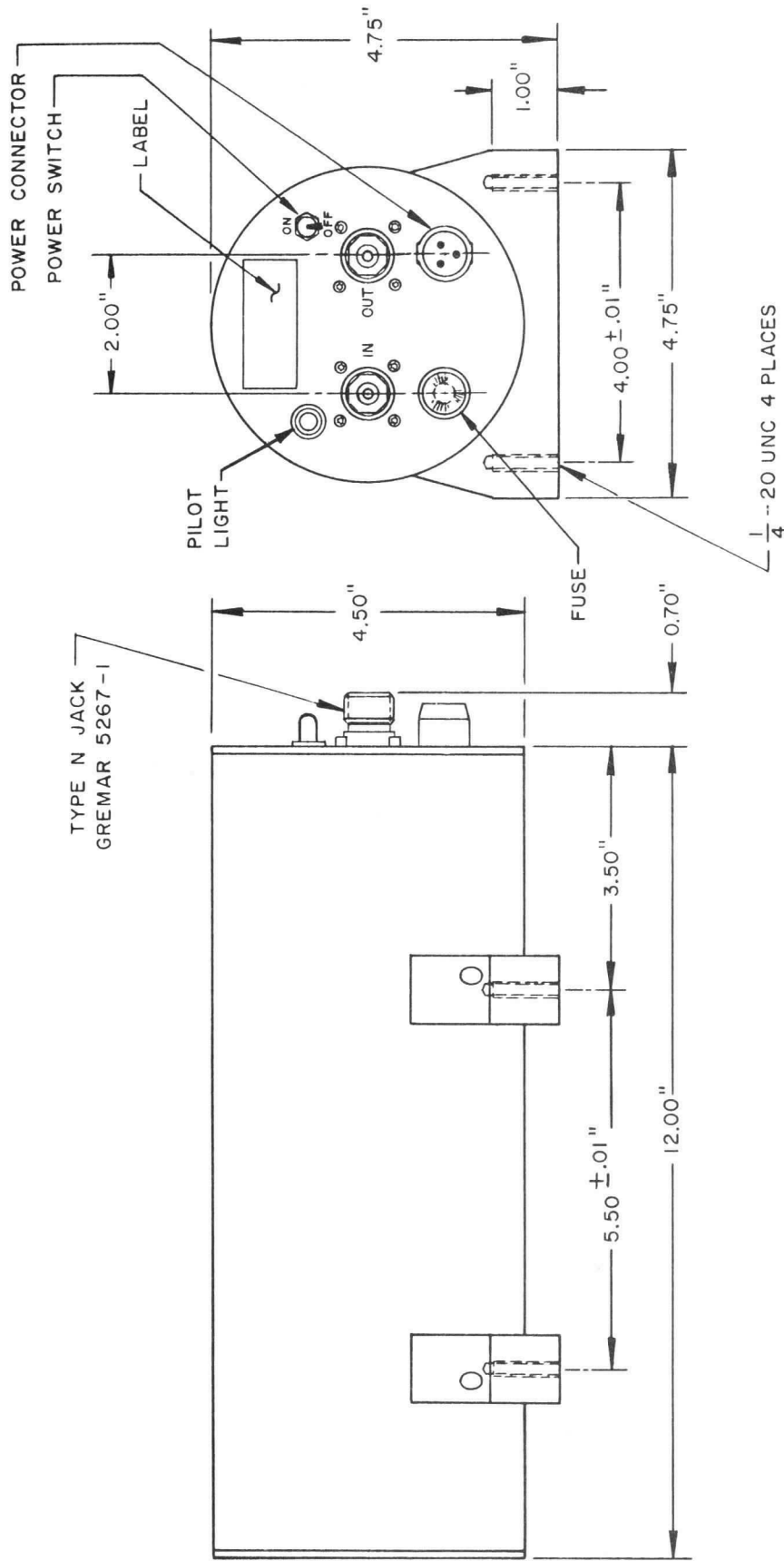

POWER CONNECTIONS	
DEUTSCH DM960I-3P	
PIN	CONNECTION
1	117 VAC
2	GROUND
3	117 VAC

OUTLINE DRAWING OF THE WJ-384



Vol. 8, No. 14; October, 1966

WJ-393

18.0 TO 26.5 GHz, LOW-NOISE PERMANENT-MAGNET
TRAVELING-WAVE AMPLIFIER WITH INTEGRAL POWER SUPPLY

The WJ-393 extends the Watkins-Johnson family of low-noise integral power supply permanent-magnet focused traveling-wave amplifiers into the millimeter wavelength region. This K-band amplifier offers a guaranteed maximum noise figure of 13 dB over the 18.0 to 26.5 GHz frequency range, but typically can be expected to yield a noise figure of less than 11 dB over much of the range. Saturated power output is 0 dBm minimum, and small signal gain is 25 dB minimum.

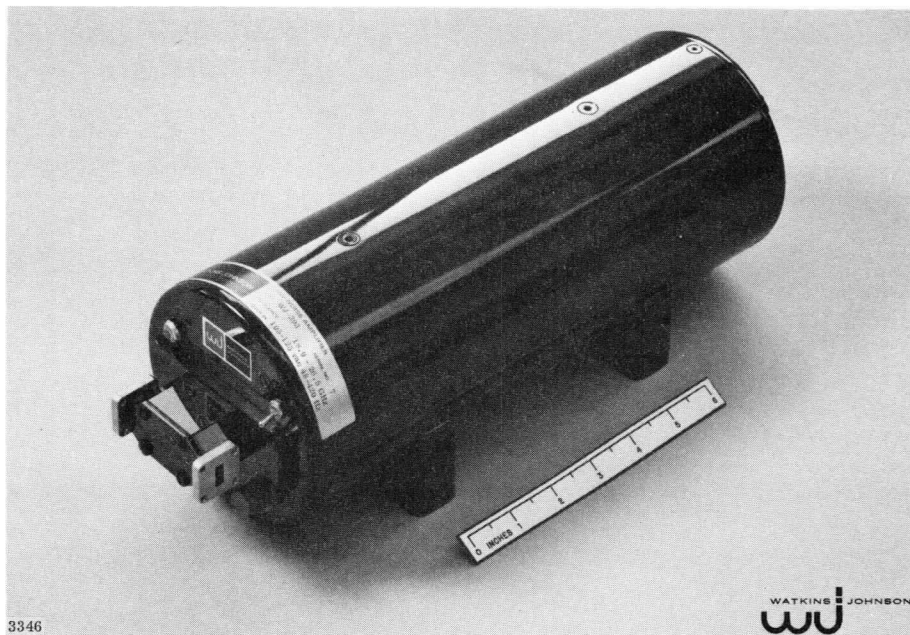

The WJ-393 amplifier package includes a shielded permanent magnet that is not adversely affected by adjacent PM tubes or ferromagnetic material. Also integral with the package is a factory-set power supply whose total power consumption from the 115-volt ac source is typically 20 watts. All components are regulated or compensated for full specification performance over the specified temperature range.

The weight of this amplifier is less than 18 pounds and it occupies a space, excluding connectors, of 12 inches in length by 4.75 inches in height.

The same conservative design and careful processing techniques which are responsible for long life in other Watkins-Johnson low-noise amplifiers, have been extended to this

amplifier. Similar amplifiers of this type have attained MTBF's in excess of 15,000 hours (99% confidence level). This low-cost-per-operating-hour performance is characteristic of the WJ-393 and all other amplifiers in this rugged family.

Installation and operation of the WJ-393 are simplified by rugged construction. When mounted in any orientation by the four threaded mounting holes, the WJ-393 can withstand vibrational forces of over 5 g at frequencies up to 500 Hz, and shock in any plane of over 15 g, 11 millisecond duration.

Details of electrical and mechanical characteristics are given in the attached specification sheet. Special units can be supplied with even a lower guaranteed noise figure over selected portions of the band.

Additional information on the WJ-393 may be obtained through our representative in your area, or by contacting the Watkins-Johnson Company, 3333 Hillview Avenue, Palo Alto, California. Inquiries to the Palo Alto facility should be addressed to the attention of Applications Engineering.

TENTATIVE SPECIFICATION

WJ-393

18.0 TO 26.5 GHz, LOW-NOISE PERMANENT-MAGNET TRAVELING-WAVE AMPLIFIER WITH INTEGRAL POWER SUPPLY

<u>PERFORMANCE</u>	<u>Typical</u>	<u>Guaranteed</u>
Frequency	18.0 - 26.5 GHz	18.0 - 26.5 GHz
Noise Figure, Terminal	11 dB	13 dB, max.
Gain, Small Signal	28 dB	25 dB, min.
VSWR, Input and Output	1.5:1	2:1, max.
Power Output	5 dBm	0 dBm, min.

<u>ELECTRICAL REQUIREMENTS</u>	<u>Typical</u>	<u>Range¹</u>
Primary Voltage	115 V ac	115 ± 10 V ac
Primary Frequency	60 Hz	48 - 420 Hz
Primary Power	20 W	30 W, max.

ENVIRONMENTAL CHARACTERISTICS

Temperature, Operating	0°C to +50°C
Vibration	
a) 0.10 Inch, Double Amplitude	5 to 33 Hz
b) 5 g, Single Amplitude	33 to 500 Hz
Shock	15 g, 11 ms

MECHANICAL CHARACTERISTICS

Amplifier Length (excluding connectors)	12 inches, max.
Amplifier Cross Section	4.75 inches, max.
Amplifier Weight	18 pounds, max.
Primary Power Connection, Deutsch Receptacle	DM9601-3P
RF Connectors (WR-42 Waveguide)	UG-597/U flange

¹ Every tube will meet the guaranteed performance specifications for any voltage lying within these ranges.

WATKINS-JOHNSON COMPANY
Stanford Industrial Park
3333 Hillview Avenue
Palo Alto, California 94304

Telephone: (415) 326-8830
Teletype: 910-373-1253

October, 1966

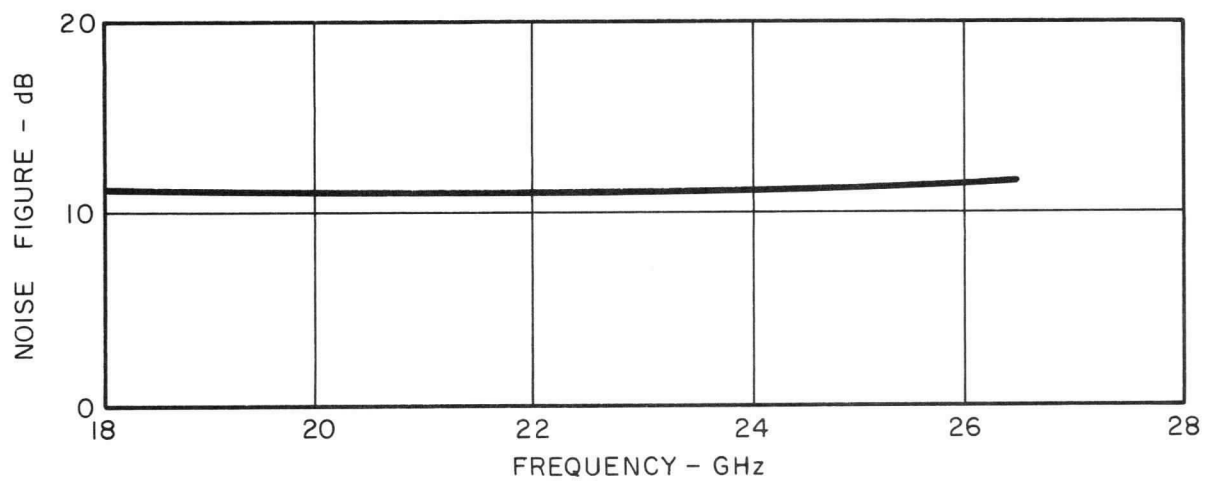
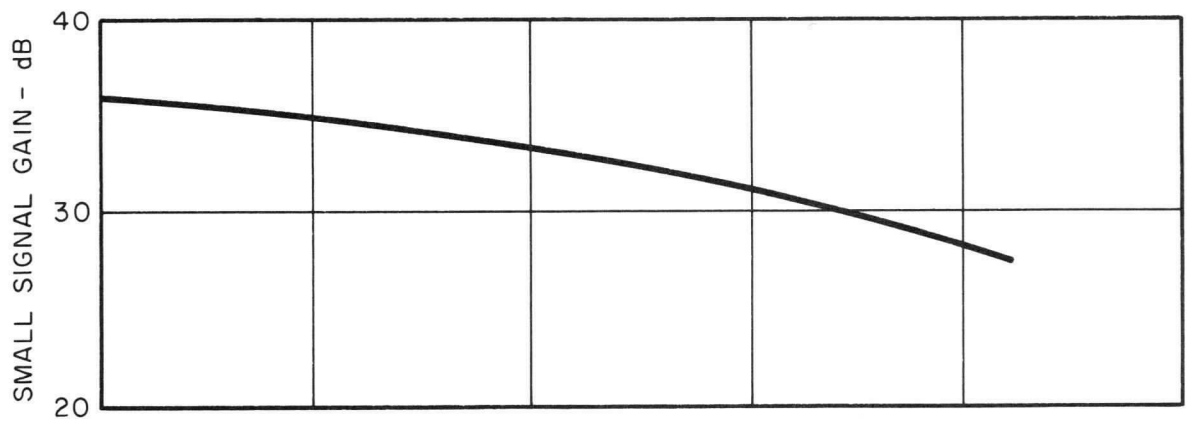
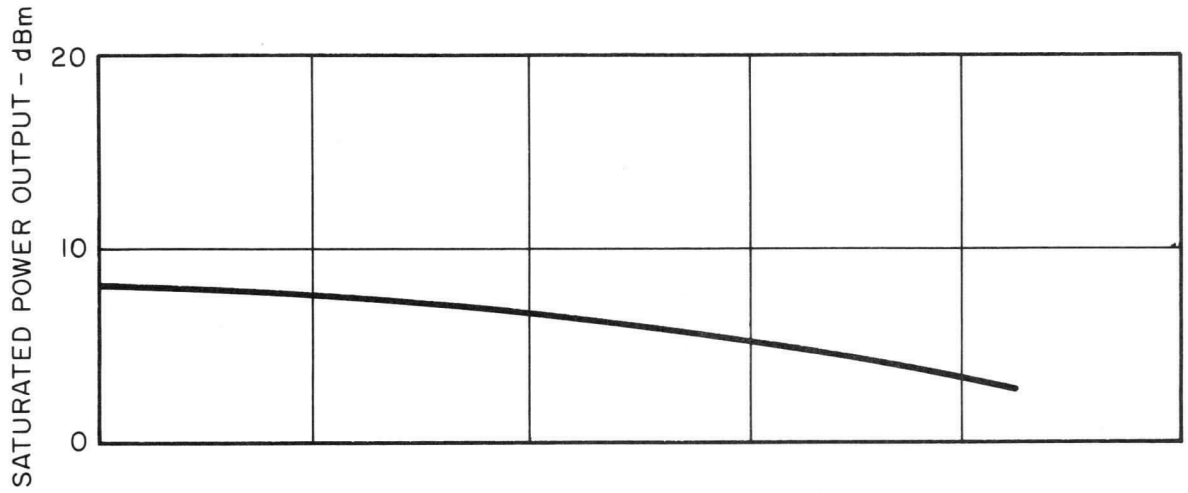

WJ - 393 PERFORMANCE CHARACTERISTICS

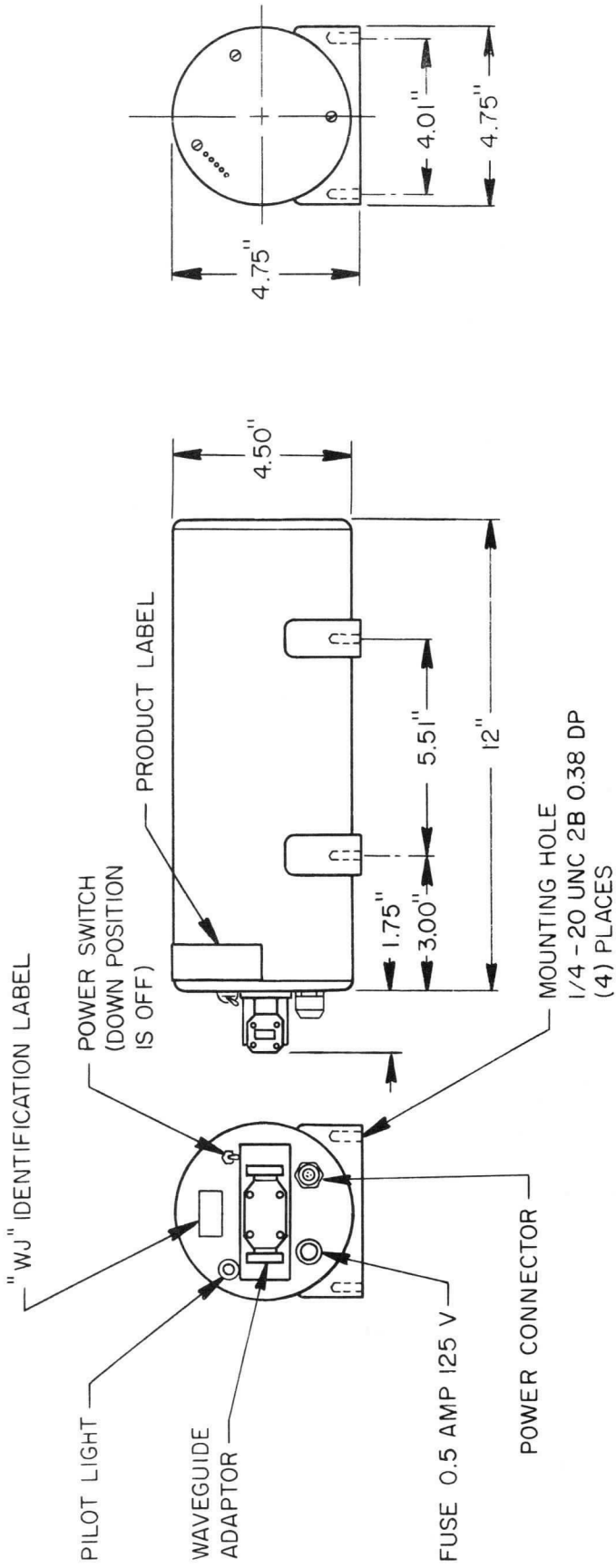

WJ-393 OUTLINE DRAWING



Vol. 8, No. 13; September, 1966

WJ-399

8 to 12 GHz, 40 MILLIWATT LOW-NOISE PERMANENT-MAGNET
TRAVELING-WAVE AMPLIFIER WITH INTEGRAL POWER SUPPLY

With the addition of the WJ-399 to its family of PM-focused integral power supply amplifiers, Watkins-Johnson Company continues to increase the dynamic range capability of its X-band low-noise amplifiers. Like its lower-power predecessors, the WJ-399 is completely self-contained, adjustment-free, and operates with only an ac line voltage input.

This 40 milliwatt version of the Watkins-Johnson low-noise family has a typical noise figure of 9 dB, and can be operated next to similar units or in the vicinity of ferromagnetic materials without degradation of performance. It weighs less than 18 pounds, and measures 12 inches in length (less connectors) by 4.5 inches in diameter. Power drain from the 115-volt ac source is approximately 20 watts.

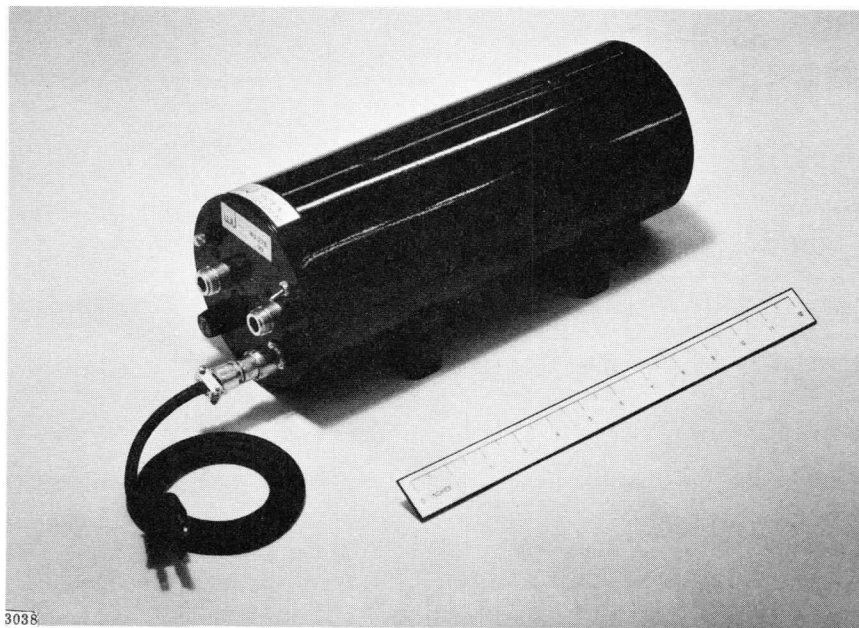

The WJ-399 offers a guaranteed maximum noise figure of 11 dB over the frequency range from 8 to 12 GHz. Small-signal gain is 25 dB minimum, and saturated power output is 16 dBm minimum.

The amplifier may be mounted in any orientation without degradation of performance. Rugged construction of the tube, magnet, and power supply assembly assures reliable

operation under vibrational forces of 5 g, at frequencies up to 2,000 Hz. Full specifications are met over the operating temperature range of -54°C to $+71^{\circ}\text{C}$. The environmental characteristics of the WJ-399 meet or exceed the corresponding requirements of MIL-E-5400, Class 2 Specification. The same conservative design and careful processing techniques which have given long life in other Watkins-Johnson low-noise amplifiers have been extended to this new member of the permanent-magnet focused family.

Details of electrical and mechanical characteristics are given on the attached Tentative Specification sheet, Outline Drawing, and Typical Performance curves.

Additional information about the WJ-399 may be obtained through our representative in your area, or by contacting Watkins-Johnson Company, 3333 Hillview Avenue, Palo Alto, California. Inquiries to our Palo Alto facility should be addressed to the attention of Applications Engineering.

TENTATIVE SPECIFICATION

WJ-399

8 to 12 GHz, 40 MILLIWATT LOW-NOISE PERMANENT-MAGNET TRAVELING-WAVE AMPLIFIER WITH INTEGRAL POWER SUPPLY

<u>PERFORMANCE</u>	<u>Typical</u>	<u>Guaranteed</u>
Frequency	8 to 12 GHz	8 to 12 GHz
Noise Figure, Terminal	9 dB	11 dB, max.
Gain, Small Signal	28 dB	25 dB, min.
VSWR, Input and Output	1.5:1	2:1, max.
Power Output	19 dBm	16 dBm, min.

<u>ELECTRICAL REQUIREMENTS</u>	<u>Typical</u>	<u>Range¹</u>
Primary Voltage	115 V ac	115 \pm 10 V ac
Primary Frequency	60 Hz	48 to 420 Hz
Primary Power	20 W	

ENVIRONMENTAL CHARACTERISTICS²

Temperature	-54 ^o C to +71 ^o C
Vibration	
a) 0.10 Inch, Double Amplitude	5 to 30 Hz
b) 5 g, Single Amplitude	30 to 2,000 Hz
Shock	15 g, 11 ms

MECHANICAL CHARACTERISTICS

Amplifier Length (excluding connectors)	12 inches, max.
Amplifier Diameter	4.5 inches, nom.
Amplifier Weight	18 lbs, max.
RF Connectors	Type N
Primary Power Connection, Deutsch Receptacle	DM9601-3P

¹ Every tube will meet the guaranteed performance specifications for any voltage lying within these ranges.

² These environmental characteristics meet or exceed the respective requirements of MIL-E-5400, Class 2 Specification.

WATKINS-JOHNSON COMPANY
Stanford Industrial Park
3333 Hillview Avenue
Palo Alto, California 94304

Telephone: (415) 326-8830
Teletype: 910-373-1253

September 1966

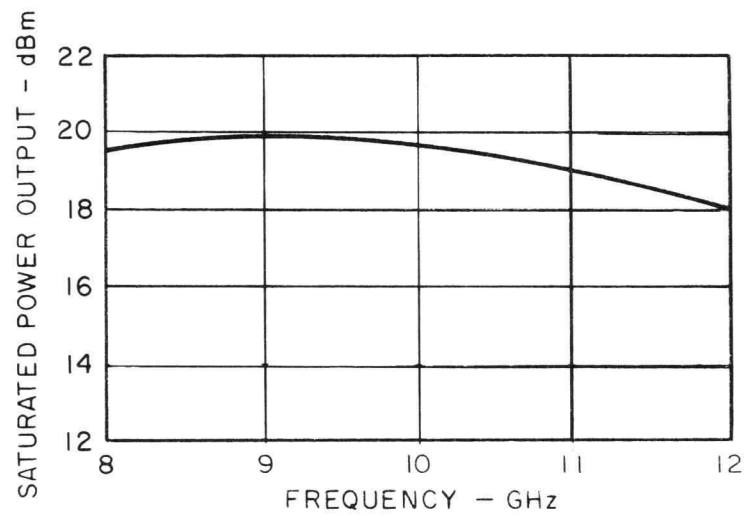
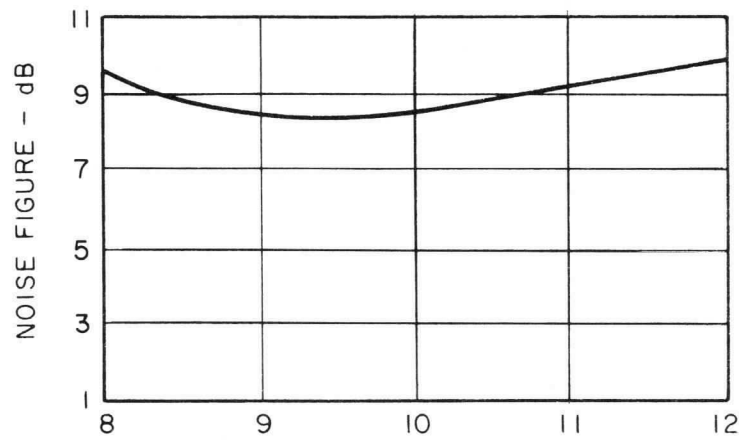
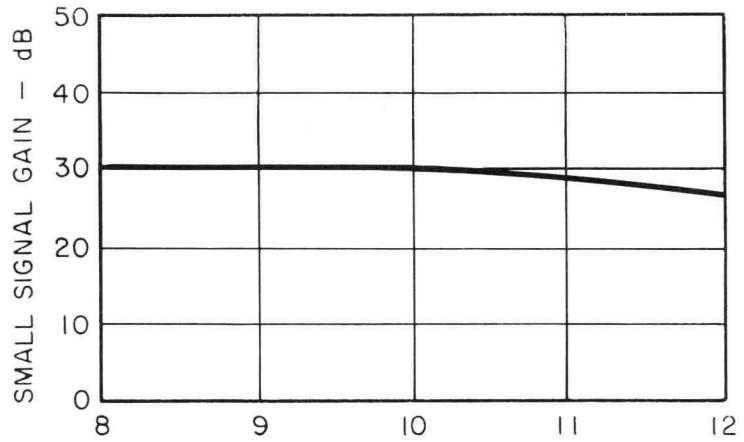

TYPICAL PERFORMANCE CHARACTERISTICS OF THE WJ - 399

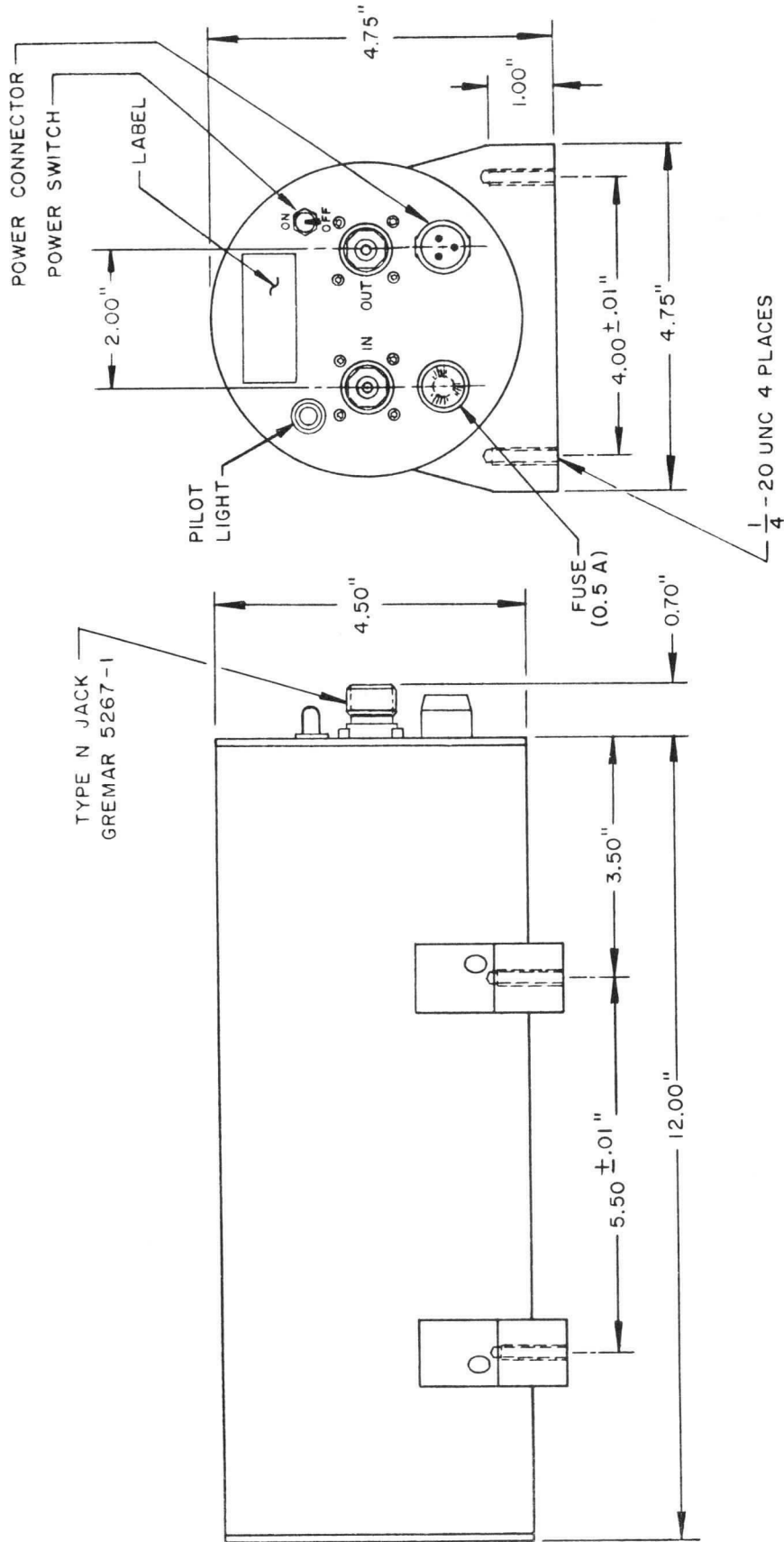

OUTLINE DRAWING OF THE WJ-399



Vol. 8, No. 9; May, 1966

WJ-403

**8.0 TO 12.0 GHz LOW-NOISE SRPM TRAVELING-WAVE-TUBE
AMPLIFIER WITH INTEGRAL POWER SUPPLY**

A significant breakthrough in low-noise traveling-wave-tube technology has been achieved by Watkins-Johnson Company. This work has culminated in the development of the WJ-403, a single-reversal permanent-magnet (SRPM) low-noise traveling-wave-tube amplifier. The performance specification of the WJ-403 is outstanding; its combination of smaller size, lower weight, and wider dynamic range, while maintaining low noise figure was unavailable in earlier X-band traveling-wave-tube amplifiers. Like its other reliable Watkins-Johnson predecessors, the WJ-403 is completely self-contained, adjustment-free, and operates with only an ac line voltage input.



The WJ-403 has a typical noise figure, small signal gain, and saturated power output of 8.5 dB, 30 dB, and 16 dBm, respectively. The amplifier is magnetically shielded such that it can be operated next to similar units, or in the vicinity of ferromagnetic materials without degradation of performance. It weighs 8 pounds, measures 10.5 inches in length (excluding connectors), and is 3 x 3 inches in cross-section.

The WJ-403 offers a guaranteed maximum noise figure of 9.0 dB over the entire 8.0 to 12.0 GHz frequency range. Small signal gain is 25 dB minimum, and the saturated power output is 13 dBm, minimum.

The amplifier may be mounted in any orientation without degradation of performance. Rugged construction of the tube, magnet, and power supply assembly assures reliable operation under vibrational forces of 10 g, at frequencies up to 2,000 Hz. Full specifications are met over the operating temperature range of -54° to $+71^{\circ}$ C. The environmental characteristics of the WJ-403 meet or exceed the corresponding requirements of MIL-E-5400, Class 2.

The same conservative design and careful processing techniques which have given long life in other Watkins-Johnson low-noise tubes have been extended to this new member of the permanent-magnet-focused family. Details of electrical and mechanical characteristics are given on the attached tentative specification sheet.

Additional information about the WJ-403 may be obtained through our representative in your area, or by contacting Watkins-Johnson Company, 3333 Hillview Avenue, Palo Alto, California. Inquiries to our Palo Alto facility should be addressed to the attention of Applications Engineering.

TENTATIVE SPECIFICATION

WJ-403

8.0 TO 12.0 GHz LOW-NOISE SRPM TRAVELING-WAVE-TUBE AMPLIFIER WITH INTEGRAL POWER SUPPLY

PERFORMANCE

	<u>Typical</u>	<u>Guaranteed</u>
Frequency	8.0 - 12.0 GHz	8.0 - 12.0 GHz
Noise Figure, terminal	8.5 dB	9.0 dB, max.
Gain, small signal	30 dB	25 dB, min.
VSWR, input and output	1.5:1	2:1, max.
Power Output	16 dBm	13 dBm, min.

ELECTRICAL REQUIREMENTS

	<u>Typical</u>	<u>Range</u> ¹
Primary Voltage	115 Vac	115 \pm 10 Vac
Primary Frequency	60 Hz	48 to 420 Hz
Primary Power	25 watts	

ENVIRONMENTAL CHARACTERISTICS²

Temperature	-54°C to +71°C
Vibration	
a) 0.10 inch, double amplitude	5 to 45 Hz
b) 10 g, single amplitude	45 to 2000 Hz
Shock	15 g, 11 ms

MECHANICAL CHARACTERISTICS

Amplifier Length (excluding connectors)	10.5 inches, max.
Amplifier Height	3 inches, max.
Amplifier Width	3 inches, max.
Weight	8 pounds, max.
Primary Power Connection, Deutsch Receptacle	DM9601-3P
RF Connectors (50 ohms, nominal)	Type N jack

1. Every tube will meet the guaranteed performance specifications within these ranges.
2. These environmental characteristics meet or exceed the respective requirements of MIL-E-5400, Class 2.

WATKINS-JOHNSON COMPANY
Stanford Industrial Park
3333 Hillview Avenue
Palo Alto, California

Telephone: (415) 326-8830
Teletype: (910) 373-1253

May 1966

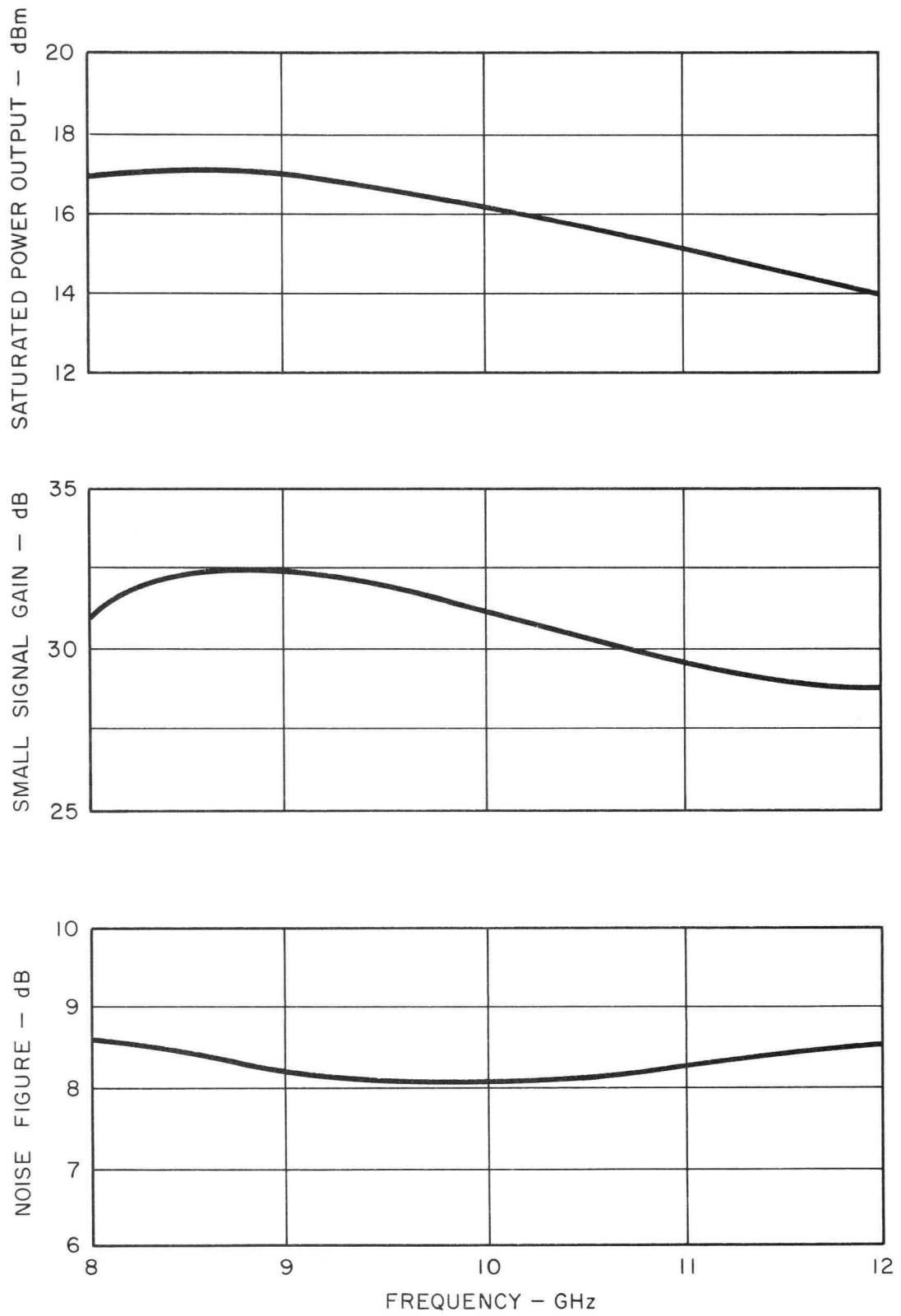

TYPICAL PERFORMANCE CHARACTERISTICS OF THE WJ-403

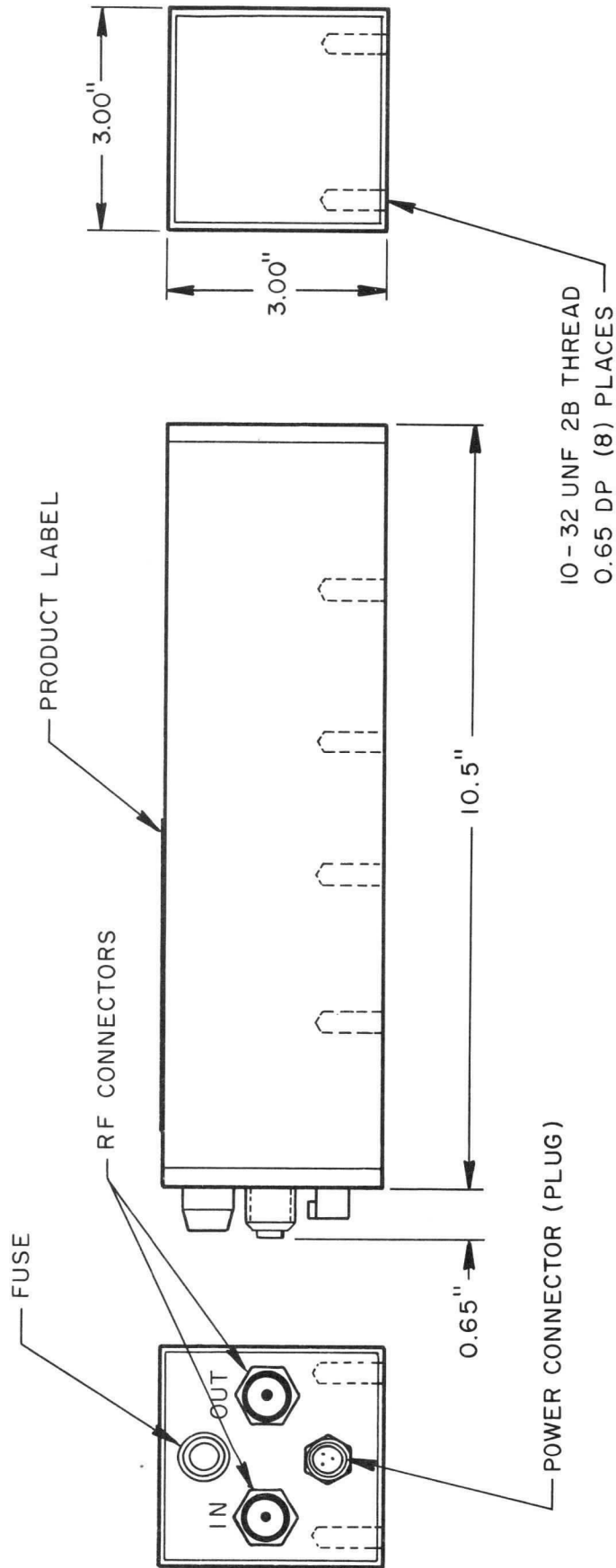

NOISE GENERATORS



Vol. 3, No. 8; August, 1961

WJ-218

A BROADBAND TRAVELING-WAVE TUBE NOISE GENERATOR
FOR S-BAND

This technical bulletin describes a wideband noise generator capable of a high noise power output over the frequency range of 2.0 to 4.0 kMc. The device is basically a traveling-wave tube amplifier with a high noise figure and high gain which uses its own electron beam noise as the input signal. The tube employs periodic permanent-magnet focusing to achieve extremely small size and low weight.

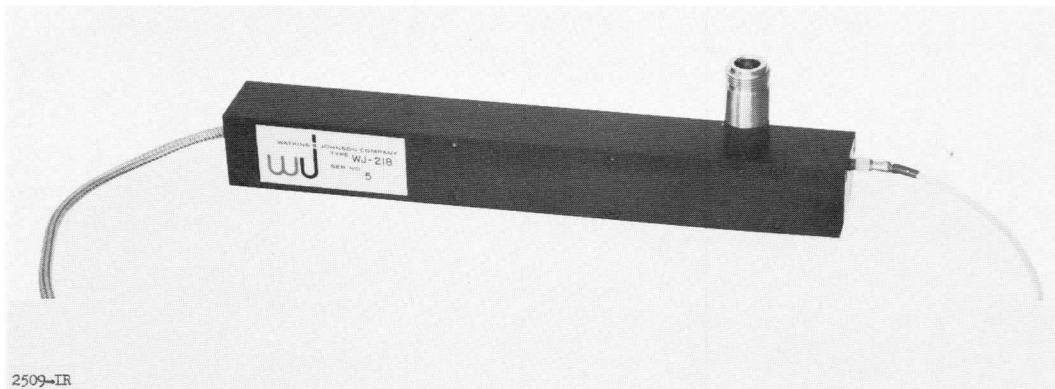

The device finds application in radar countermeasure and wide-band noise-jamming equipment. The noise power output per megacycle is adequate to drive subsequent stages of amplification.

The noise power spectral density typically has an 8-db variation between band center and band ends. This spectrum can be equalized to provide a noise power density output which is constant with frequency. The noise power output level is approximately 10 db below the saturation power level of the tube, resulting in the generation of an unclipped output noise signal.

Any further inquiries may be addressed to our Applications Engineering or to our representative in your area.

TENTATIVE SPECIFICATIONS

WJ-218

2.0 - 4.0 kMc Traveling-Wave Tube Noise Generator

PERFORMANCE

	<u>Typical</u>	<u>Guaranteed</u>
Frequency	2.0-4.0 kMc	2.0-4.0 kMc
Integrated noise power output (measured in a 2.0 kMc bandwidth)	5 mw	2 mw
Variation of noise power output over over the 2.0-4.0 kMc band (measured in a 40 Mc bandwidth)	8 db	12 db max.

ELECTRICAL REQUIREMENTS

	<u>Typical</u>	<u>Range</u>
Heater voltage	7.25 v	7.0-7.5 v
Heater current	0.5 a	0.45-0.55 a
Anode voltage ¹	260 v	200-270 v
Helix and collector voltage ^{1, 2}	265 v	250-270 v
Collector current	3.3 ma	2.5-4.0 ma
Cathode current	4.0 ma	3.5-5.0 ma
Focusing means	Periodic Permanent Magnet	

1. Voltages measured with respect to cathode
2. Helix and collector must be operated at ground potential

MECHANICAL

Weight	1 lb 5 oz
Capsule dimensions	1.1 x 1.1 x 9.0 inches
DC connector	Winchester PM6P
RF connector	Type N, female

WATKINS-JOHNSON COMPANY
Stanford Industrial Park
3333 Hillview Avenue
Palo Alto, California

DAvenport 6-8830

1 August 1961

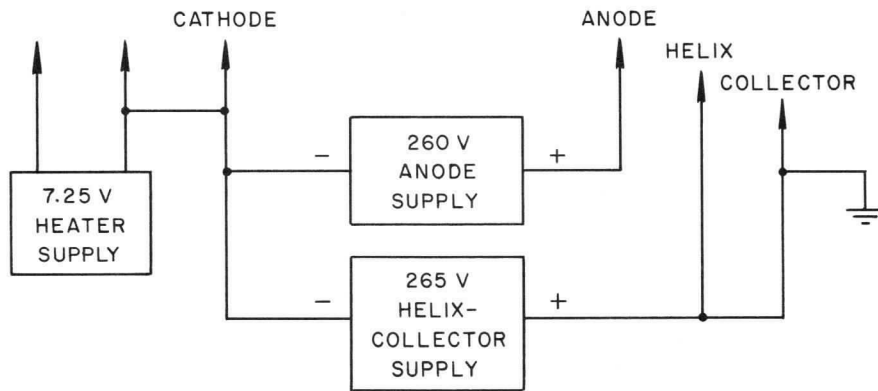

TYPICAL POWER SUPPLY FOR WJ-218 NOISE GENERATOR TRAVELING-WAVE TUBE

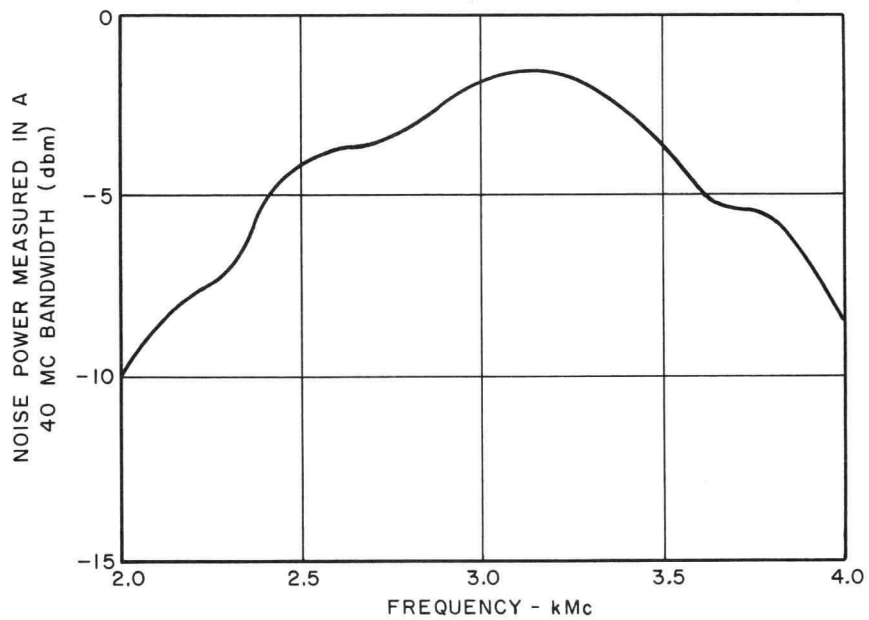

WJ-218 TYPICAL NOISE POWER MEASURED WITH A TUNABLE FILTER HAVING A 40 MC BANDWIDTH FOLLOWED BY A BROADBAND THERMISTOR MOUNT

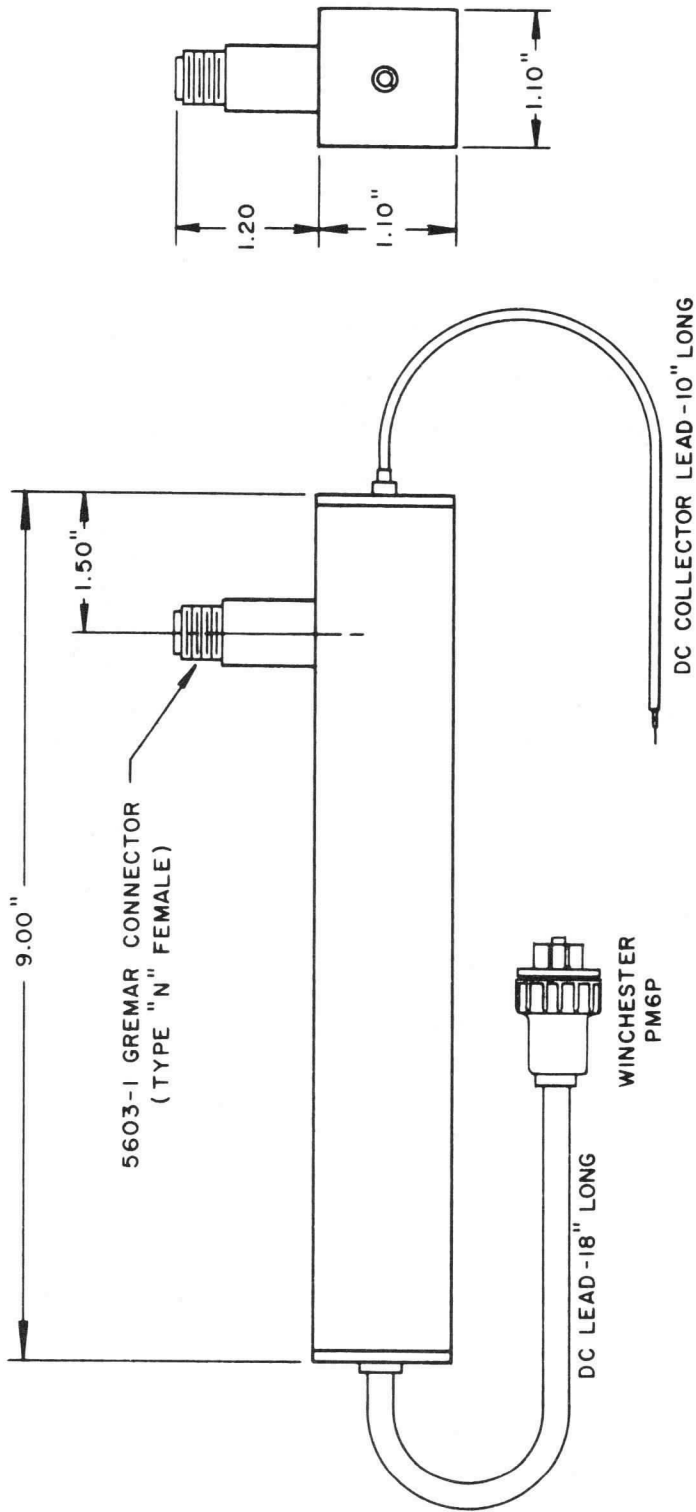

OUTLINE DRAWING - WJ-218 NOISE GENERATOR TRAVELING WAVE TUBE

MISSILE AND SPACE TUBES



Vol. 4, No. 7; September, 1962*

WJ-217

15 Watt CW S-Band Traveling-Wave Tube

The WJ-217 is a general purpose broadband traveling-wave tube amplifier which covers 2.0 to 4.0 Gc. Its compact size and rugged design make it applicable to aircraft and ground equipment. Weighing less than 6 pounds, it provides 15 to 20 watts of saturated power output over the band with an efficiency of 18 to 21 percent including heater power.

Under severe environmental conditions it maintains extremely low values of spurious amplitude and phase modulation. Careful attention to detail in design and construction assure reliable performance for extended periods of time, making this tube an ideal choice for communications and telemetry systems. These design features include high temperature processing (650°C), low cathode operating temperature (720°C), low current density (150 ma/cm^2), and a simple and rugged mechanical construction.

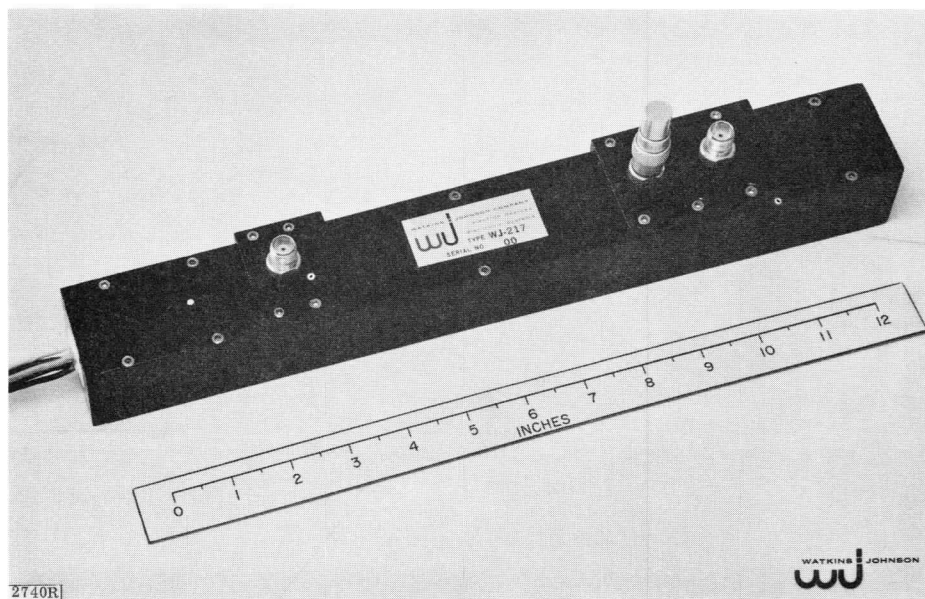

Focusing is provided by temperature compensated periodic permanent magnets of the ferrite type. A smaller, lighter weight version of the WJ-217 is also available which uses platinum-cobalt alloy magnets.

* This Technical Bulletin presents up-to-date information of the WJ-217, first described in Vol. 3, No. 6; July 1961.

The attached specification describes this power amplifier and shows typical performance curves and mechanical characteristics.

Further inquiries may be addressed to our Applications Engineering or to our representative in your area.

TENTATIVE SPECIFICATION

WJ-217 15-20 Watt CW S-Band Traveling-Wave Amplifier Tube

PERFORMANCE

	<u>Typical</u>	<u>Guaranteed</u>
Frequency	2.0-4.0 Gc	2.0-4.0 Gc
Power output	15-20 watts	15 watts
Small signal gain	30 db	25 db
Large signal gain	20-25 db	20 db

ELECTRICAL REQUIREMENTS

	<u>Typical</u>	<u>Range</u>
Heater voltage	6.3 v	6.0-7.0 v
Heater current	0.75 a	0.70-0.80 a
Anode voltage ¹	2400 v dc	2400-2600 v dc
Anode current	50 μ a dc	0-100 μ a dc
Helix voltage	2300 v dc	2250-2450 v dc
Helix current	1.0 ma dc	0-3 ma dc
Collector voltage ^{1, 2}	1800 v dc	1600-1900 v dc
Cathode current	55 ma dc	50-70 ma dc
Focusing	Periodic Permanent Magnet	

ENVIRONMENTAL

Operational vibration	5 g, 25 to 3000 cps
Shock	15 g, 11 milliseconds
Temperature	-20°C to +40°C

MECHANICAL CHARACTERISTICS

Weight	6 pounds, max.
Capsule dimensions	1.80 x 1.80 x 13.75 inches (see outline)
DC connections	Flying leads
RF connections	TNC female
Cooling	Conduction, by means of heat sink mounting base

Note 1. Voltages measured with respect to cathode

Note 2. Collector is operated at ground potential and all other voltages are above or below ground potential

WATKINS-JOHNSON COMPANY
Stanford Industrial Park
3333 Hillview Avenue
Palo Alto, California

Telephone: Davenport 6-8830

September 1962
(Revision of July 1961
original)

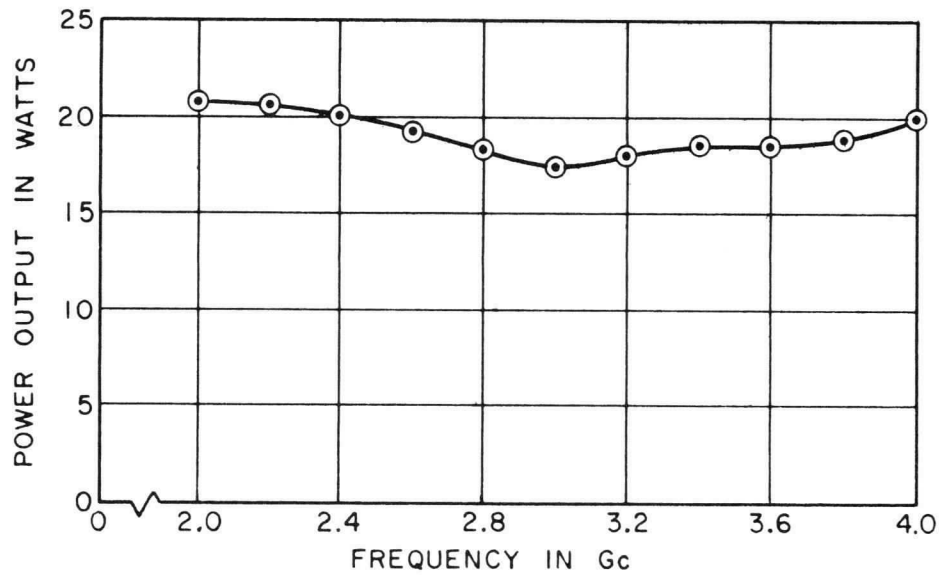
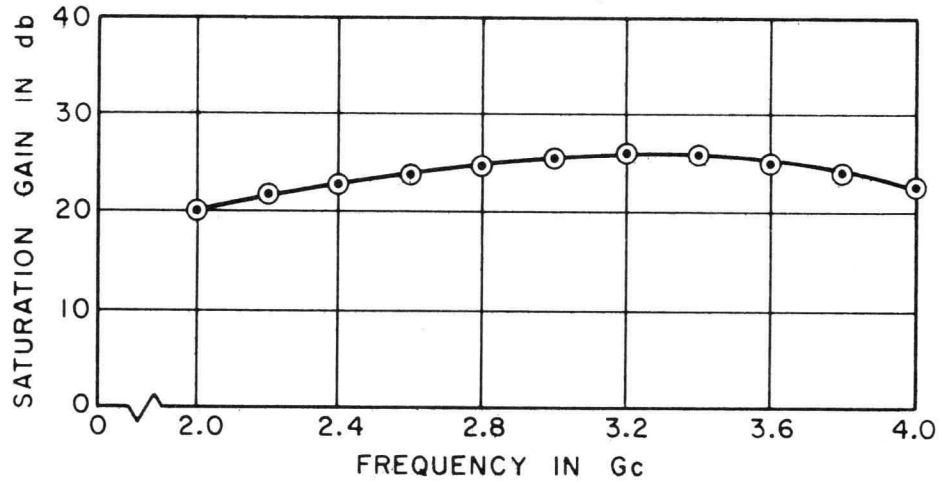

TYPICAL POWER OUTPUT AND SATURATION GAIN vs
 FREQUENCY FOR WJ-217 TRAVELING-WAVE TUBE AMPLIFIER

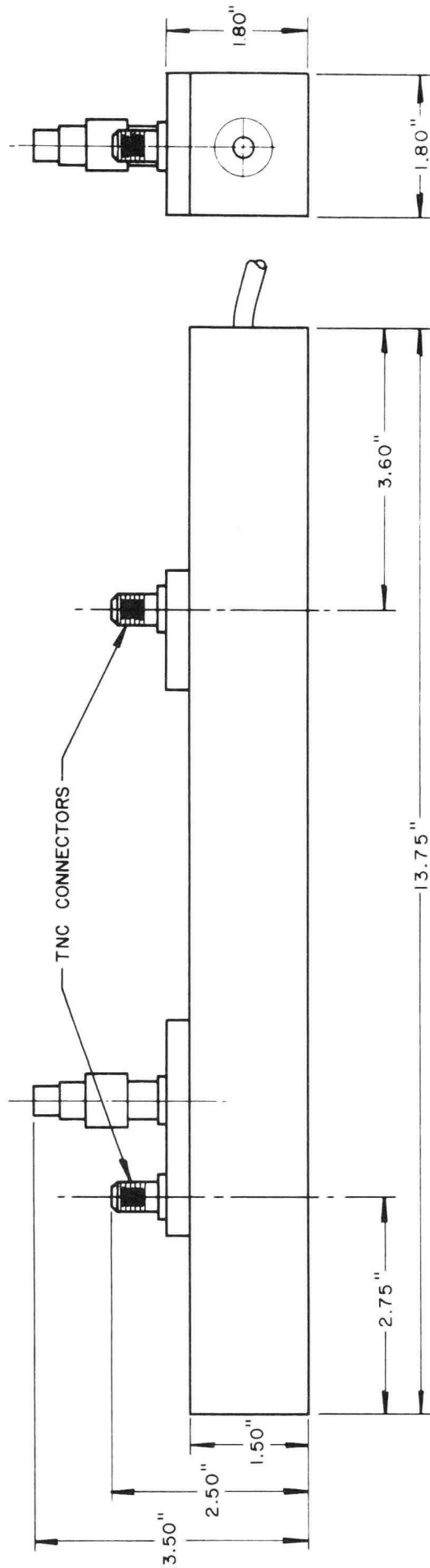

OUTLINE DRAWING OF WJ-217 15 WATT CW S-BAND TRAVELING-WAVE TUBE AMPLIFIER



Vol. 4, No. 6; August, 1962

WJ-237

A 2.5 Watt CW Traveling-Wave Tube
For Space Communications

The WJ-237 is a medium power traveling-wave tube developed for use in satellite transmitter applications where absolute reliability, small size, light weight, and maximum over-all efficiency are mandatory. This traveling-wave tube is designed to operate from 1.70 to 2.00 Gc. The frequency range or power level can be altered either through a slight design change or a shift in operating voltages.

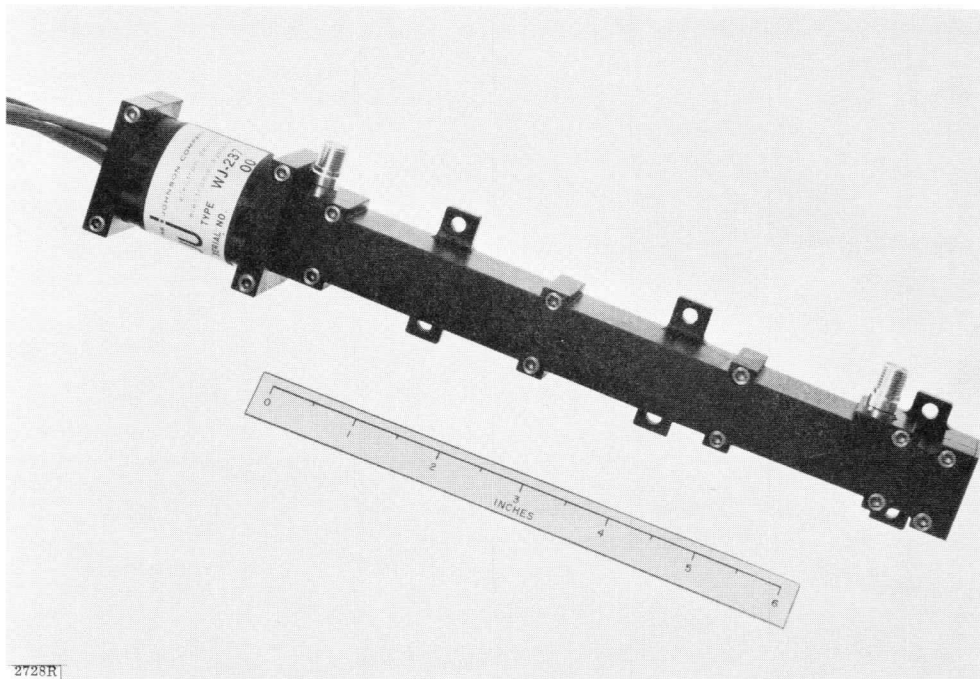

This light weight periodic-permanent magnet focused tube exhibits an over-all efficiency including heater power from 23 to 27 percent, together with the superior focusing (beam transmission is typically 97 percent or better at saturation) that is necessary in a long-life satellite transmitter.

Necessary design features to assure the maximum in reliable, long-life operation under the extreme environment of vehicle boost are included.

The tube incorporates an extremely rugged electron gun assembly wherein the anode, cathode and other parts are securely joined together in a rigid assembly and then mounted in a manner which eliminates any relative motion among gun, helix, envelope and magnet stack. Mechanical ruggedness of the helix is accomplished by securely glazing each turn of the helix to three ceramic support rods, thereby eliminating any turn-to-turn motion of the helix. In addition, the helix is rigidly locked into the vacuum envelope to eliminate motion during vibration and to provide a good thermal path from helix to heat sink. Additional strength is achieved by encapsulating the entire tube within the magnet structure and capsule.

A life of many thousands of operating hours is assured due to the low cathode current density (117 milliamps per sq. centimeter), low cathode operating temperature, 650°C bakeout and processing schedule, proper ion control, superior focusing during operation, and the use of ultra-clean, modern manufacturing facilities.

Any further inquiries should be addressed to Applications Engineering or our representative in your area.

TENTATIVE SPECIFICATION

WJ-237, 1.7 to 2.0 Gc, 2.5 Watt CW Traveling-Wave Tube

<u>PERFORMANCE</u>	<u>Typical</u>	<u>Guaranteed</u>
Frequency	1.7-2.0 Gc	1.7-2.0 Gc
Minimum power output over the frequency range	2.6-2.7 w	2.5 w min.
Efficiency ¹	24%	20% min.
Gain (large-signal)	33 db	30 db min.
Noise figure	30 db	35 db max.
Spurious coherent output	> 40 db down	40 db down min.
Tube VSWR (operating)		
Input	1.4:1	2.0:1 max.
Output	2.0:1	2.5:1 max.
Maximum load VSWR for stable operation	∞ , any phase	

TYPICAL ELECTRICAL REQUIREMENTS

	<u>Typical</u>	<u>Range</u>
Heater voltage	3.0 v	2.75-3.25 v
Heater current	.75 a	.65-.85 a
Cathode current	19.5 ma	19-20 ma
Anode voltage ^{2, 3}	870 v	840-900 v
Anode current	.05 ma	.03-.20 ma
Helix voltage ^{2, 3}	770v	765-780 v
Helix current (under saturated power output and depressed collector conditions)	.35 ma	.2-1.0 ma
Collector voltage ^{2, 3}	450 v	420-460 v
Collector current	19.1 ma	18.5-19.7 ma
Focusing	Periodic Permanent Magnet	

Note: 1. Efficiency is defined as the minimum rf output power across the band, divided by the total dc power input including heater power.

2. All voltages measured with respect to cathode.

3. Collector is operated at ground potential, and all other voltages are above or below ground potential.

MECHANICAL

Length	9.9 inches nom.
Cross section	1.22 inches by 1.51 inches nom.
DC connections	Flying leads
RF connections	TM female (GRFF-2235)
Cooling	Conduction only
Weight	17.5 oz. nom.
Operating position	Any

ENVIRONMENTAL REQUIREMENTS

Storage temperature	-50°C to +75°C
Operating temperature	-50°C to +75°C
Humidity	To 90%
Salt atmosphere	As encountered in coastal regions for checkout
Pressure range, operation	The tube will operate in a vacuum environment

LAUNCH ENVIRONMENT QUALIFYING TEST

Shock, two shocks in each of 6 directions	50 g, 11 ms half sine wave
Acceleration, 6 directions, 2 minutes per direction	25 g
Sinusoidal vibration 3 planes, 15 minutes per plane	5-20 cps 1/2" double amplitude 20 to 2000 cps, 25 g
Random vibration 3 planes, 3 minutes per plane	20-2000 cps at .2 g ² /cps
Temperature soak, non-operating	24 hours at -50°C and 24 hours at +75°C

In addition to normal tests verifying compliance with specifications, the end product tubes will be given the following Launch Environment Qualifying Tests:

Random vibration 3 planes, 90 seconds per plane	20-2000 cps 1/10 g ² /cps
Temperature soak, non-operating	2 hours at -50°C and 2 hours at +75°C

These measurements are made while operating the tube at a fixed, optimized point.

WATKINS-JOHNSON COMPANY
Stanford Industrial Park
3333 Hillview Avenue
Palo Alto, California
Telephone: DAvenport 6-8830

1 August 1962

TYPICAL PERFORMANCE OF THE WJ-237 HIGH EFFICIENCY TRAVELING-WAVE TUBE AMPLIFIER

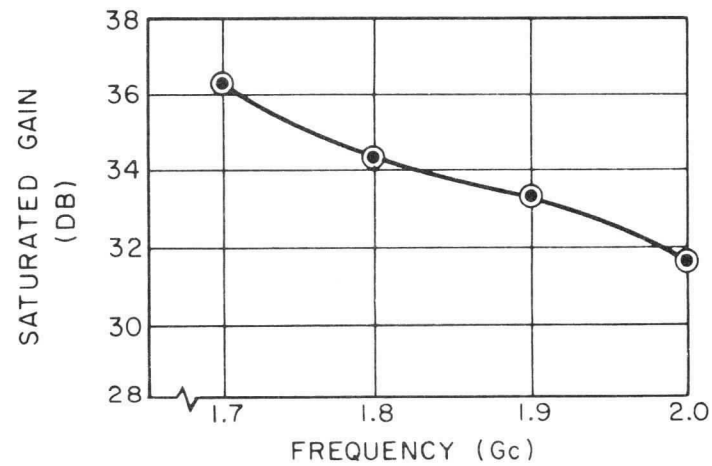
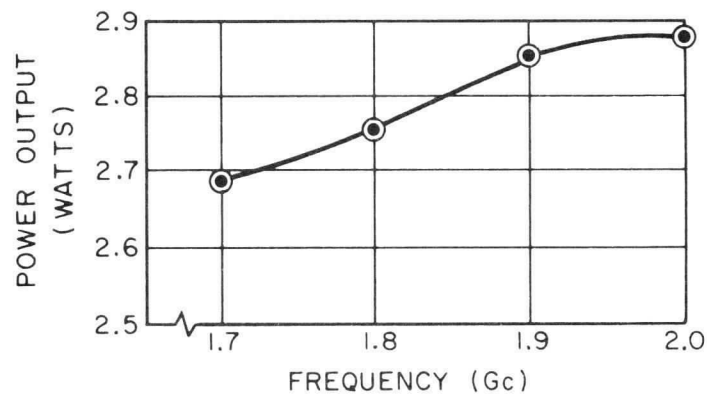
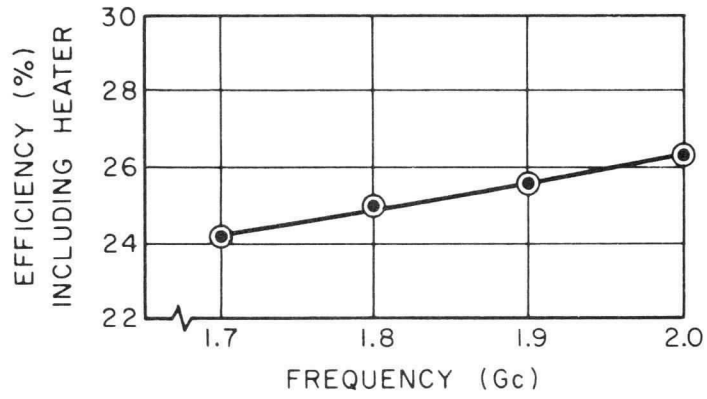

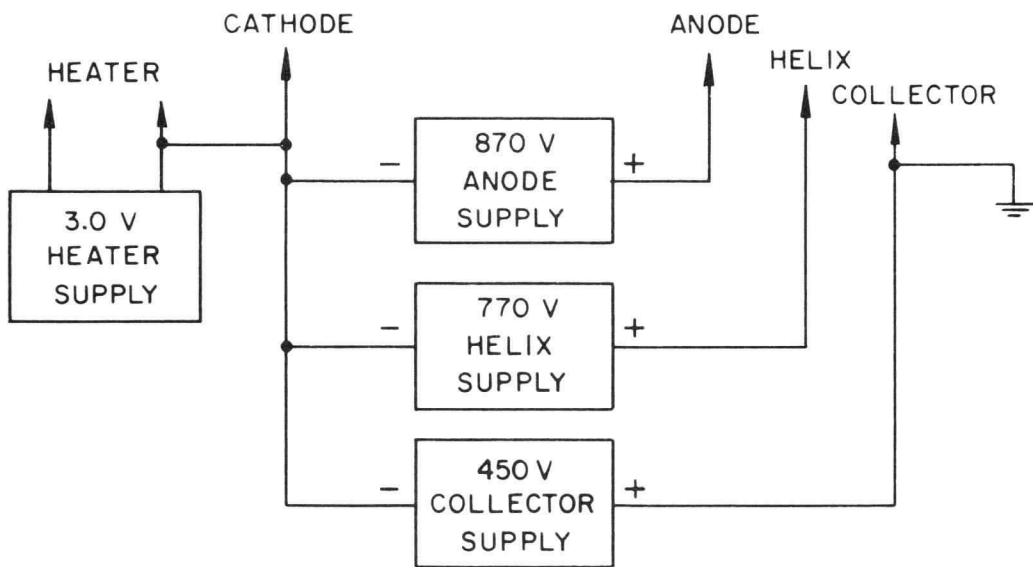

BLOCK DIAGRAM OF TYPICAL POWER SUPPLY FOR WJ-237
HIGH EFFICIENCY TRAVELING-WAVE TUBE AMPLIFIER.

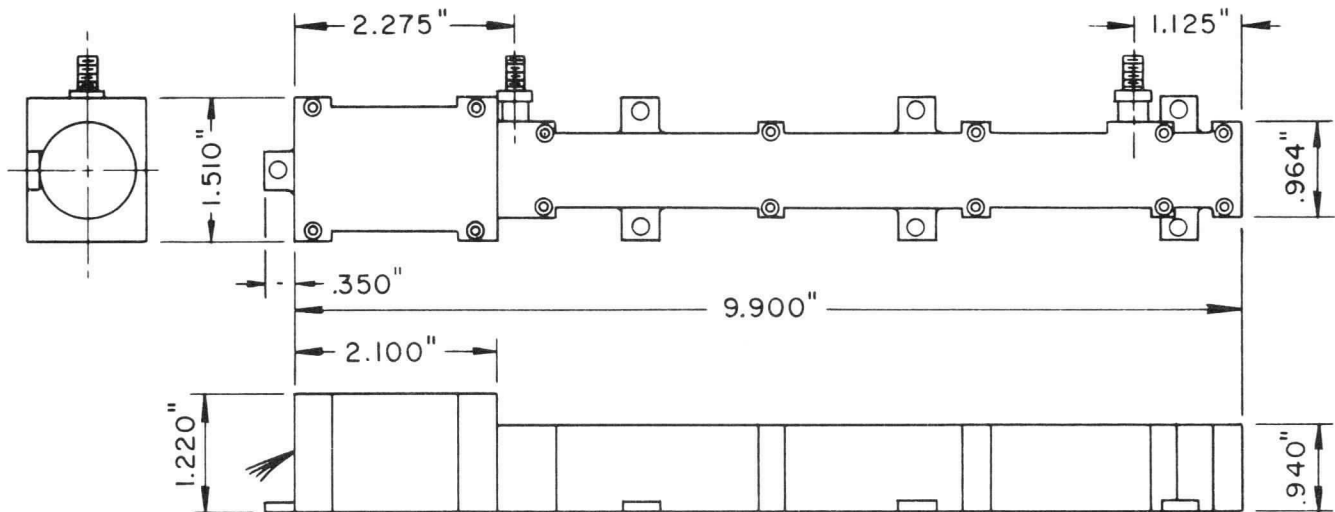

OUTLINE DRAWING OF WJ-237 HIGH EFFICIENCY TRAVELING-WAVE
TUBE AMPLIFIER.

HIGH POWER TUBES



Vol. 5, No. 5; August, 1963*

THE WJ-228

A GRIDDED HIGH-GAIN
C-BAND TRAVELING-WAVE AMPLIFIER

The WJ-228 is a high power, high gain C-band traveling-wave amplifier for pulsed operation. This tube is of rugged, light-weight construction backed by production experience gained through the manufacture of large quantities of this type. Reliable operation and long life have been proven by extensive environmental and life test programs over the past two years. The WJ-228 produces 14 kw power output with 0.5 watt drive. It employs a high-mu grid which permits modulation of the beam by means of a 500-volt pulse.

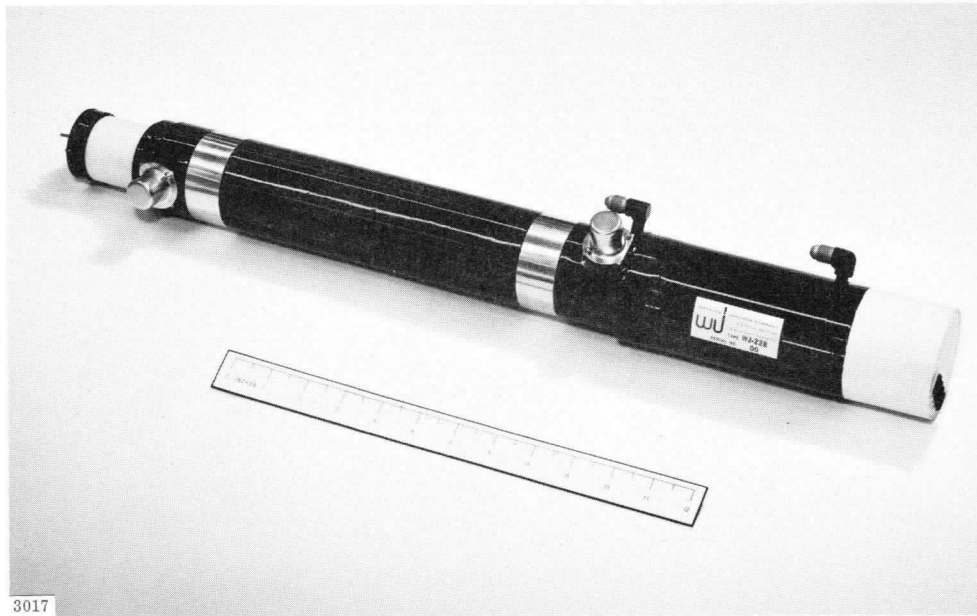
Design Features

The slow-wave circuit is similar to that in the WJ-206 and is shown schematically in Fig. 1. The construction is all metal-ceramic and is designed to withstand severe shock and vibration. A temperature-compensating jacket is provided so that no appreciable change in characteristics will occur over a wide range of operating temperatures.

* New information on the WJ-228, which was first described in Technical Bulletin Vol. 3, No. 12; October, 1961.

The peak cathode loading is small (2 a/cm^2) which is compatible with very long life. This is accomplished by means of a high-convergence gridded gun which is a new feature of this tube.

The integral focusing system requires no alignment of any kind and leakage fields are negligible.

An insulated collector is provided so that increased efficiency can be obtained by means of collector depression. Efficiencies as high as 34 percent have been measured under operating conditions close to those indicated in the tentative specification attached. The collector cooling jacket is at ground potential so that no electrical insulation is required in the coolant system. The tube outline drawing is shown in Fig. 2.

Tube Operation

A typical measured power output curve is shown in Fig. 3. Typical operating voltages, currents, and other operating data are shown in the attached tentative specification. The performance can be altered somewhat at different operating voltages. Inquiries are invited. A typical connection diagram for utilization of the depressed collector feature is shown in Fig. 4.

The tube may be operated at duty cycle up to 0.024 so that average power in excess of 340 watts is available.

Any further inquiries may be addressed to our Applications Engineering or to our representative in your area.

TENTATIVE SPECIFICATION

WJ-228, A GRIDDED HIGH-GAIN
C-BAND TRAVELING-WAVE AMPLIFIER

PERFORMANCE

	<u>Typical</u>	<u>Guaranteed</u>
Frequency	5.4-5.9 Gc	5.4-5.9 Gc
Power output peak		
Average of six points*	14 kw	12 kw
Lowest point in band	11 kw	10 kw
Gain (at 0.5 w drive)		
Average of six points*	44.4 db	43.8 db
Lowest point in band	43.4 db	43.0 db
Gain variation (at 0.5 w drive - 6 points*)	±0.6 db	±1.5 db

ELECTRICAL REQUIREMENTS

	<u>Typical</u>	<u>Range</u>
Cathode voltage	23.0 kv	23.0 ± 1.0 kv
Collector current		
Without drive or depression	3.6 a peak	3.4 a peak min.
With drive, without depression	3.3 a peak	2.9 a peak min.
With drive and depression	2.6 a peak	2.4 a peak min.
Body current		
Without drive or depression	0.5 a peak	0.7 a peak max.
With drive, without depression	0.8 a peak	1.2 a peak max.
With drive and depression	1.5 a peak	1.7 a peak max.
Duty cycle	0.024	0.028 max.
Pulse duration	2 μsec	5 μsec max.
Grid pulse voltage	450 v peak	420-500 v
Grid bias voltage	-250 v	-250 ± 5 v
Grid current	0.5 a peak	0.7 a max.
Grid capacitance (to all else)	26 μμf	30 μμf max.
Circuit and anode voltage	Ground	Ground
Heater voltage	12 v, 60 cycle ac	12.5 v max.
Heater current	2.3 a	2.5 a max.
Ion pump voltage	+3 kv to collector	3 ± 0.15 kv
Ion pump current, operating	1.0 μa	20 μa max.

MECHANICAL

Tube dimensions

See outline drawing, Fig. 2

Weight (including ion pump)

14 lb.

RF connectors**

5/8" ID - semi-rigid coax

Coolant flow

Depressed

0.3 gpm of water - 10 psig pressure drop max.

Non-depressed

0.5 gpm of water - 18 psig pressure drop max.

* At equal increments of 100 Mc

** Coaxial to either "C" band waveguide or type N coax adaptors will be provided if desired

WATKINS-JOHNSON COMPANY
Stanford Industrial Park
3333 Hillview Avenue
Palo Alto, California

August 1963
Revision of
February 1962
Revision

Telephone: Area Code 415
DAvenport 6-8830

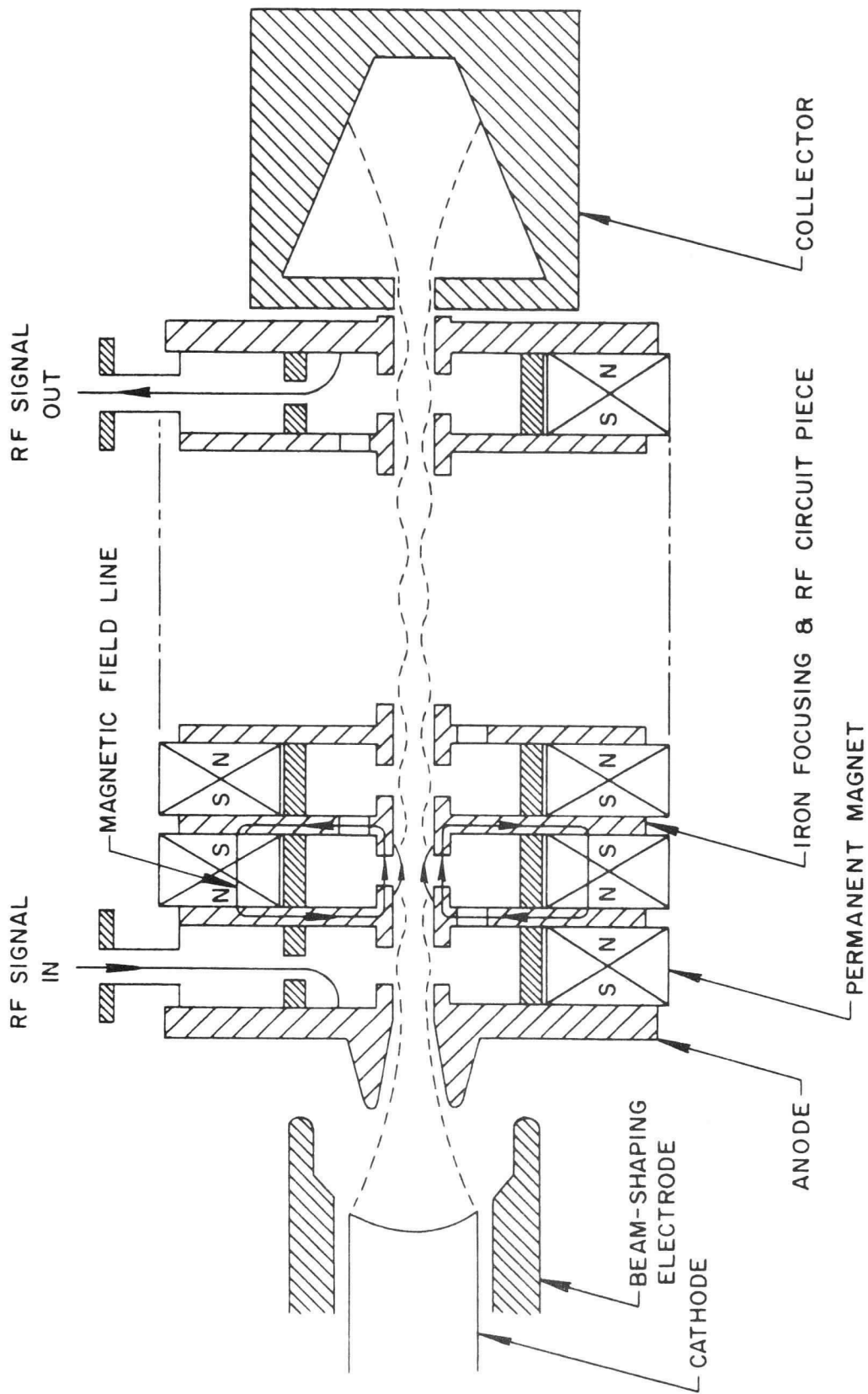

FIG. 1. SCHEMATIC DRAWING SHOWING THAT THE MAGNETIC CIRCUIT IS INTEGRAL WITH THE RF CIRCUIT. IT CAN BE SEEN THAT A SECTION OF THE CAVITY WALL ALSO SERVES AS A FLUX GUIDE FOR THE MAGNETIC FOCUSING CIRCUIT.

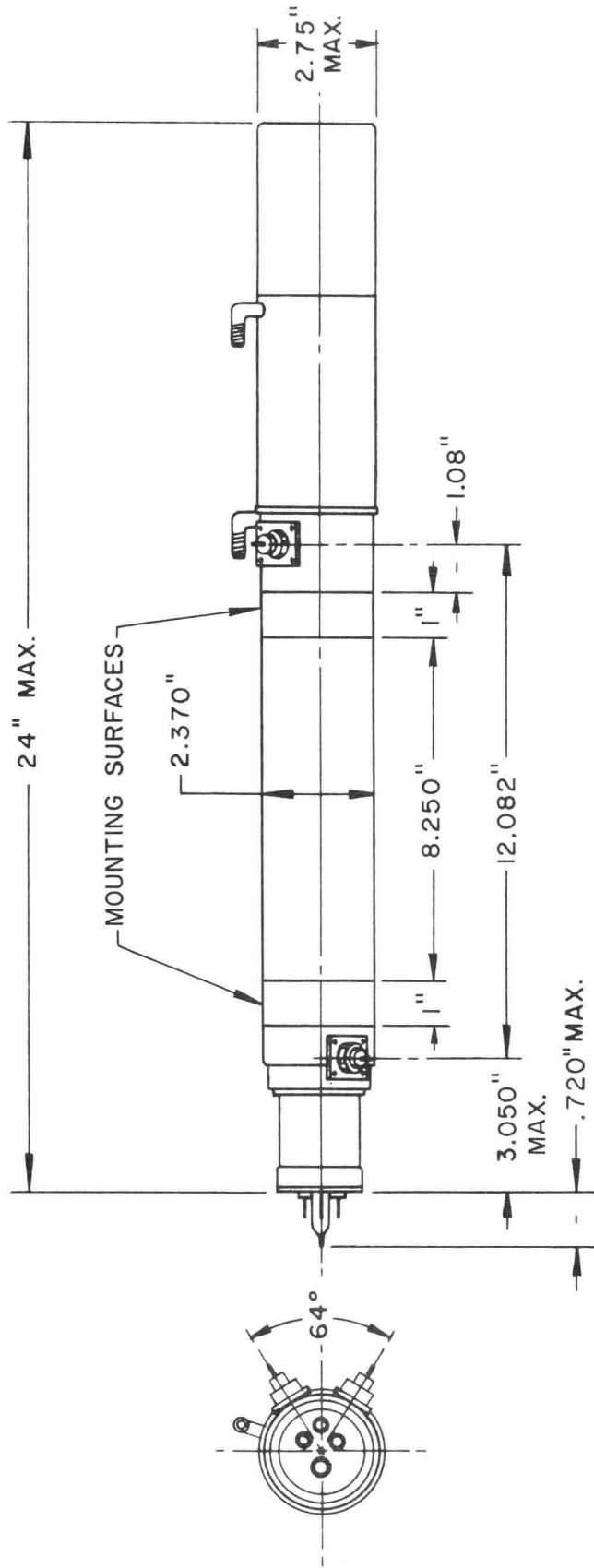

FIG. 2. OUTLINE DRAWING - WJ-228 C-BAND TRAVELING-WAVE AMPLIFIER.

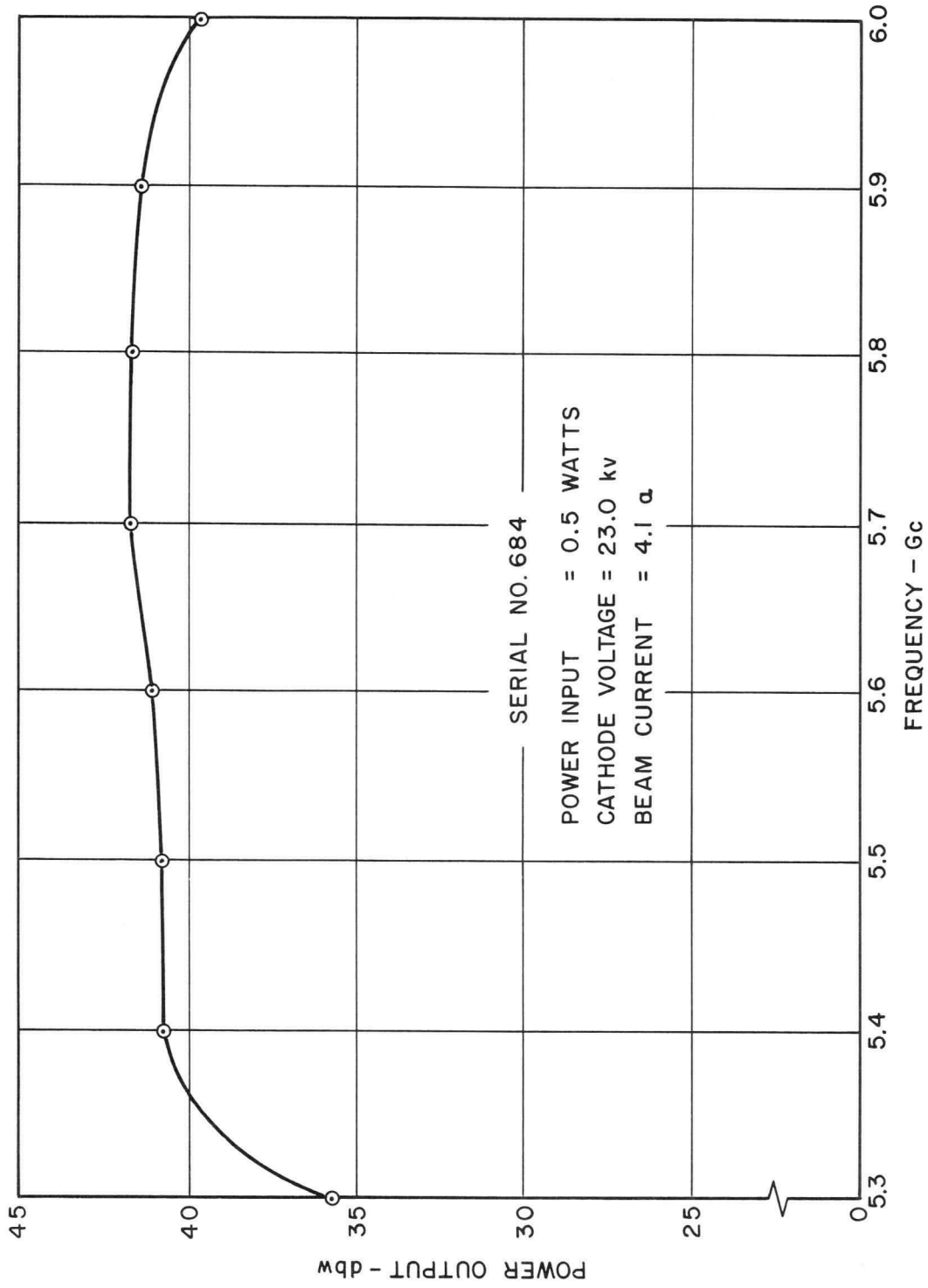

FIG. 3. POWER OUTPUT vs FREQUENCY FOR THE WJ-228 C-BAND TRAVELING-WAVE AMPLIFIER.

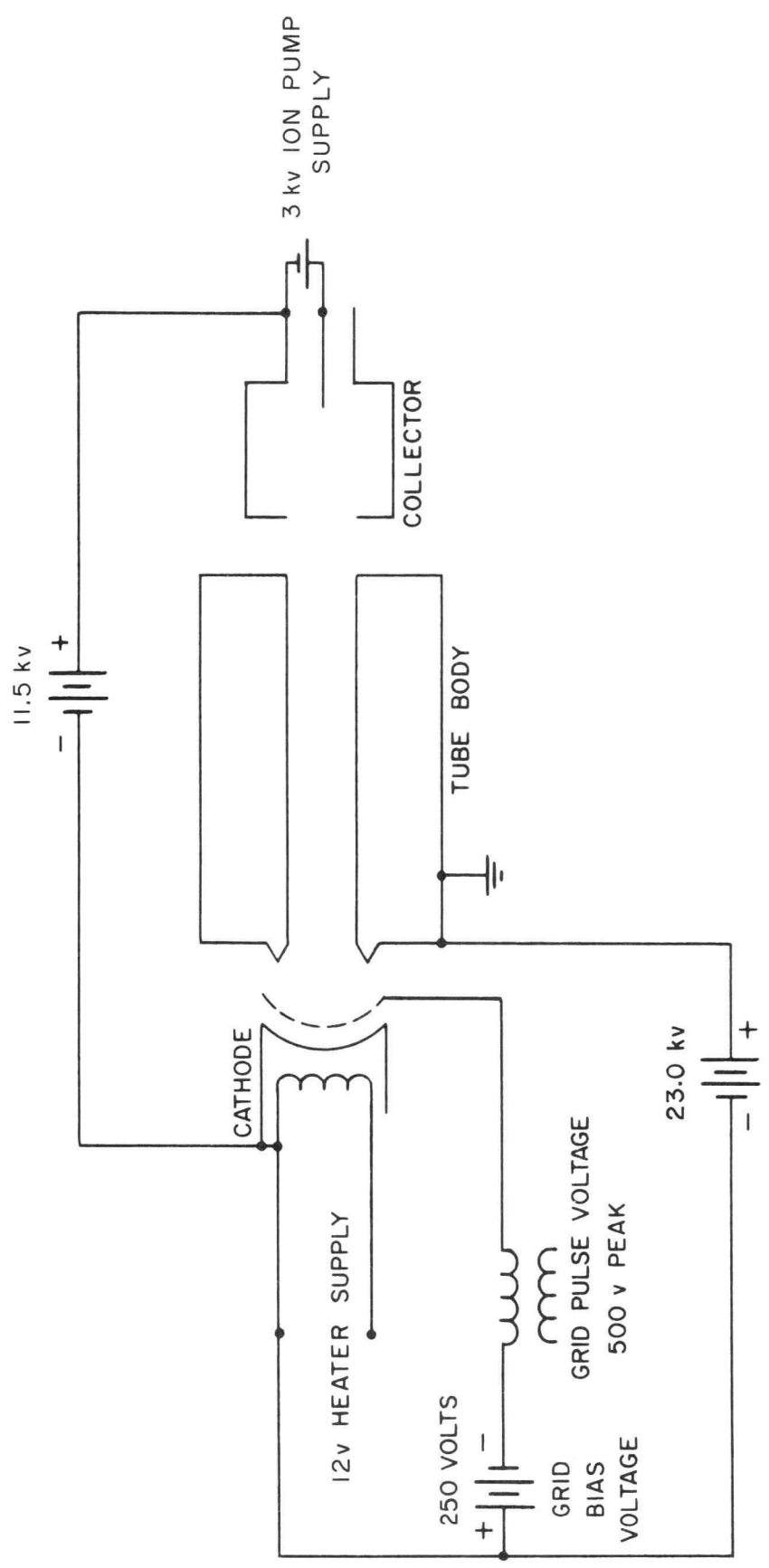

FIG. 4. WJ-228 C-BAND TRAVELING-WAVE AMPLIFIER CONNECTION DIAGRAM.



Vol. 8, No. 1, January 1966

WJ-340

1.0 TO 2.0 GHZ, GRIDDED, 1-KILOWATT TRAVELING-WAVE-TUBE

The WJ-340 is a high-power, octave-bandwidth traveling-wave-tube designed for operation in L-band. Of rugged, lightweight construction, the WJ-340 uses a brazed helix structure supported on beryllia wedges, with a metal-ceramic envelope. The gridded, solid-beam electron gun operates at a perveance of 5×10^{-6} . A high- μ grid permits beam modulation with a 275-volt pulse, with pulse durations down to less than 100 ns. Beam focusing is accomplished by means of a solenoid having a 15-inch field of 520 oersteds. The TWT and solenoid may be air-cooled as an integral unit, or the solenoid may be separately water-cooled. Overall dimensions of the tube are 1.5 inches in diameter and 18.25 inches in length (excluding connectors and solenoid). Dimensions details are outlined in Figure 1.

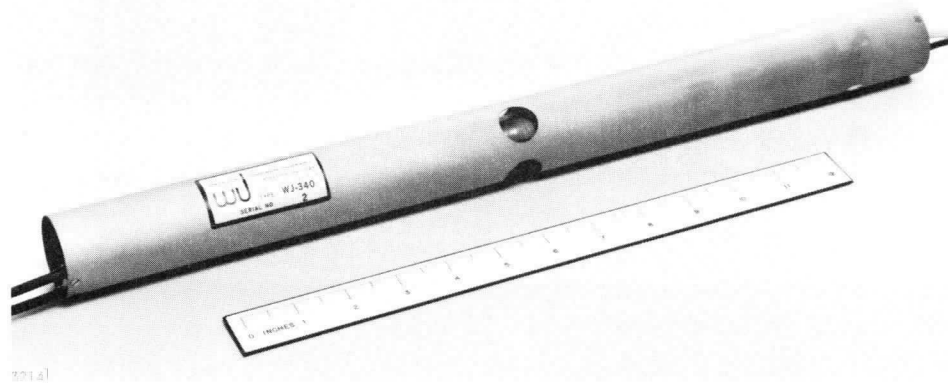

Typical power output and gain curves for the one-kilowatt tube are shown in Figure 2. Voltages, currents and other electrical data are shown in the attached Tentative Specification sheet. Tube performance can be altered somewhat by variation of the voltages and currents. A block diagram of a typical power supply for the WJ-340 is shown in Figure 3.

Although the basic WJ-340 is designed for operation at a duty cycle of 0.01, factory modified versions with higher duty cycle capability are available on special order. These special tubes have slightly modified collectors which may, or may not, require water cooling, depending on the specific duty cycle.

Additional information may be obtained through our representative in your area, or by contacting Watkins-Johnson Company, 3333 Hillview Avenue, Palo Alto, California. Inquiries to our Palo Alto facility should be addressed to the attention of Applications Engineering.

TENTATIVE SPECIFICATION

WJ-340, 1.0 TO 2.0 GHZ, GRIDDED, 1-KILOWATT TRAVELING-WAVE-TUBE

<u>PERFORMANCE</u>	<u>Typical</u>	<u>Guaranteed</u>
Frequency	1.0 - 2.0 GHz	1.0 - 2.0 GHz
Power output (pulsed)	1.2 Kw	1.0 Kw, min.
Gain at saturation	33 dB	30 dB, min.
Load VSWR	2:1	2:1, max.
Duty Cycle	0.01	0.01, max.
<u>ELECTRICAL REQUIREMENTS</u>		
Cathode voltage	5.0 Kv	4.7 - 5.2 Kv
Beam current	1.8 amps	1.7 - 2.0 amps
Heater voltage	7.5 volts	7.0 - 8.0 volts
Heater current	2.2 amps	2.0 - 2.4 amps
Grid pulse voltage	275 volts	250 - 300 volts
Grid bias voltage	-200 volts	-200 volts (fixed)
Grid current	0.5 amps	0.4 - 0.6 amps
Grid capacitance	50 pF	40 - 60 pF
Circuit voltage, anode & collector	Ground	Ground
Pulse duration	5 μ sec	0.1 - 10 μ sec
Magnetic field	525 gauss	600 gauss max.
Solenoid voltage	60 volts	55 - 65 volts
Solenoid current	8.0 amps	7.5 - 8.5 amps
<u>MECHANICAL</u>		
Tube length		18.25 inches
Tube diameter		1.5 inches
RF connections		TNC (female)
Dc connections		Flying leads
Cooling		Forced air
Tube weight		3 lbs.
Solenoid length		15 inches
Solenoid diameter		4.5 inches
Solenoid weight		15 lbs.

WATKINS-JOHNSON COMPANY
Stanford Industrial Park
3333 Hillview Avenue
Palo Alto, California

Telephone: (415) 326-8830
Teletype: (910) 373-1253

December 1965

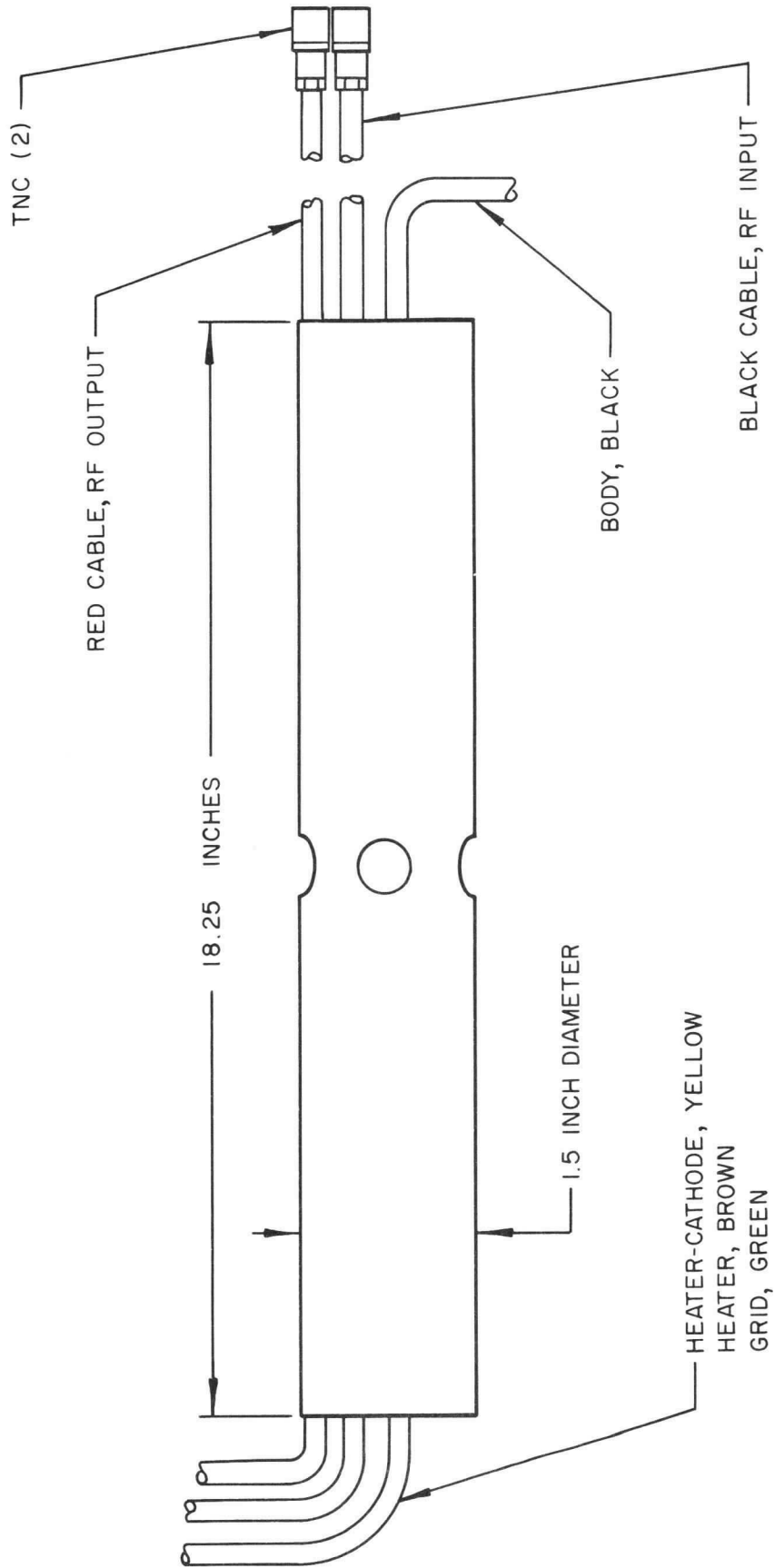

FIG. 1. OUTLINE DRAWING OF WJ-340 L - BAND TWT, EXCLUDING SOLENOID.

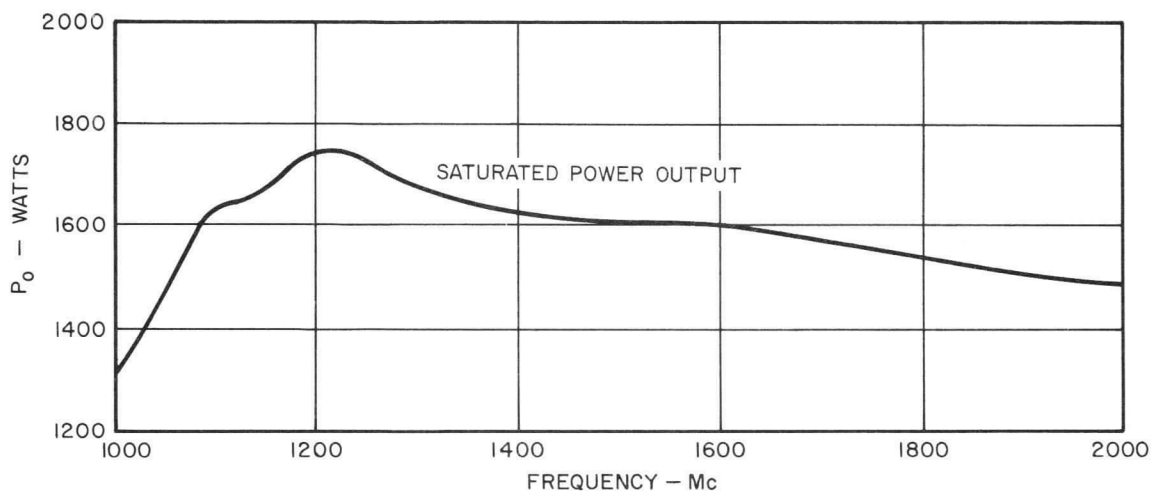
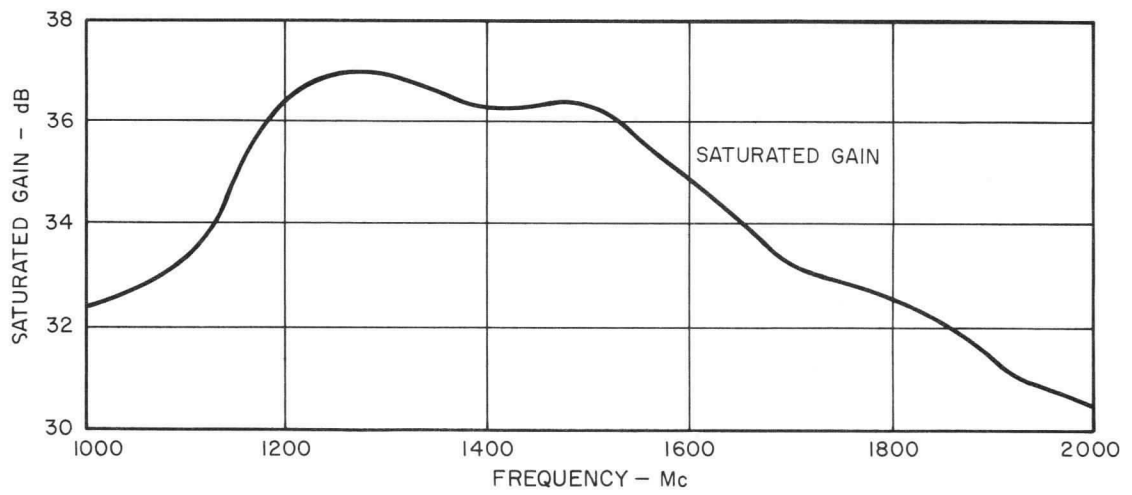
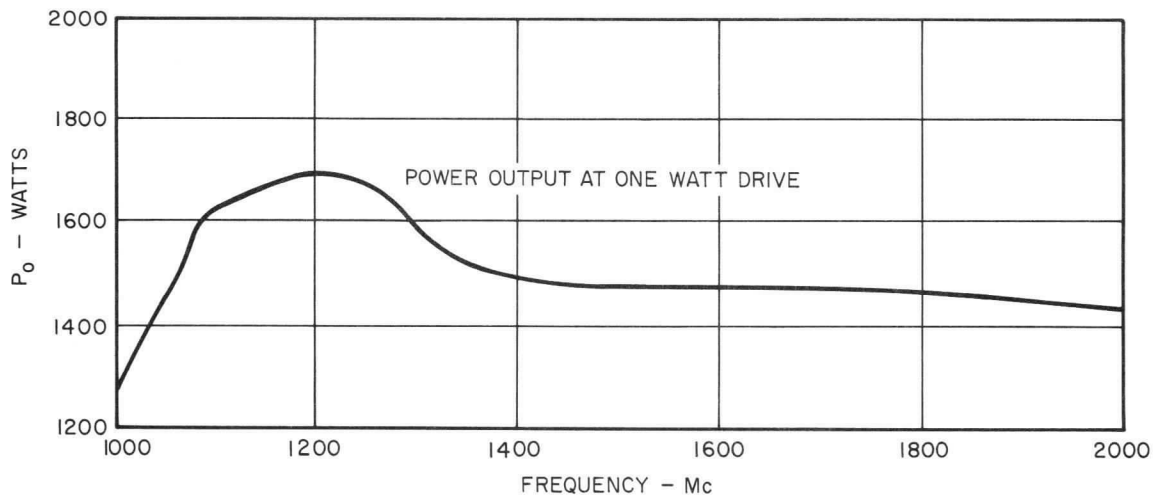

FIG. 2. TYPICAL POWER OUTPUT AND GAIN CURVES.

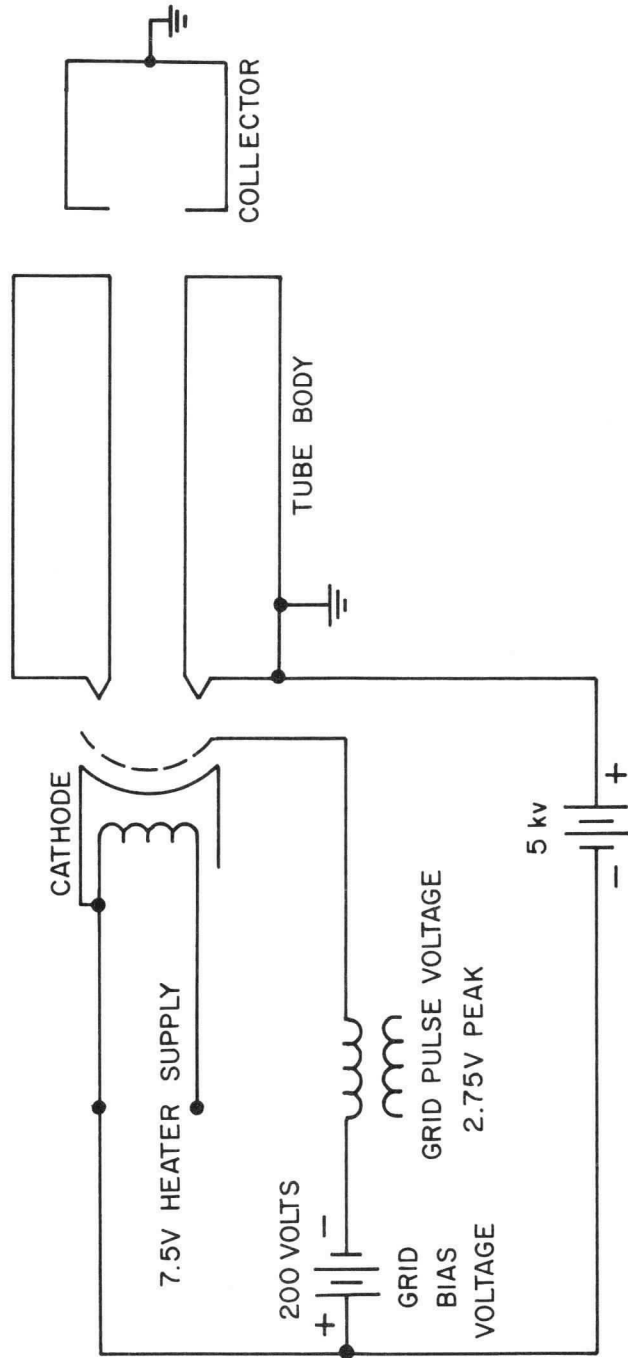

FIG. 3. BLOCK DIAGRAM OF TYPICAL POWER SUPPLY FOR WJ-340 TWT.



Vol. 8, No. 2, January 1966

WJ-341

5.3 TO 6.0 GHZ 1.0 KW CW TRAVELING-WAVE-TUBE AMPLIFIER
(SOLENOID FOCUSED)

The WJ-341 is a high power, low-gain, traveling-wave-tube amplifier for use in C-band. Providing one-kilowatt CW power output from 5.3 to 6.0 GHz, the WJ-341's rugged construction makes it suitable for use in airborne and other applications of severe environment. The design of this amplifier employs many of the techniques and components proven successful in earlier models of Watkins-Johnson high-power amplifiers.

Particular emphasis has been placed on conservative thermal design to preclude damage resulting from high temperatures generated within the WJ-341 amplifier. Coolant passages are provided for the slow-wave structure, collector, and focusing solenoid.

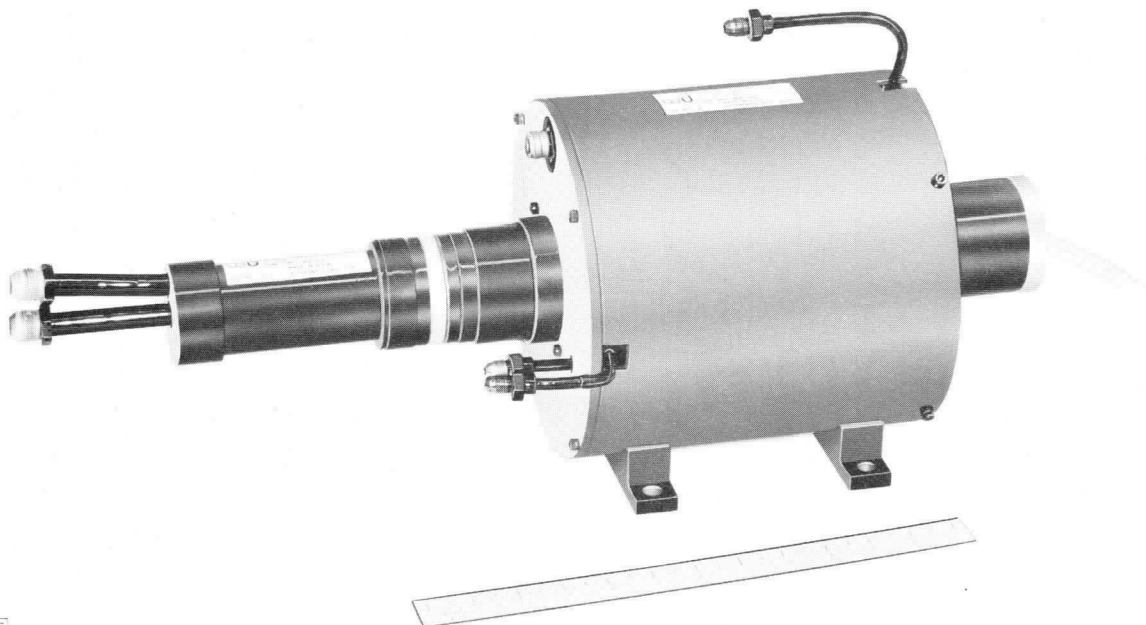

7595

The slow-wave structure is a coupled-cavity circuit similar to that used in several other high-power tubes manufactured by Watkins-Johnson Company. Cavity walls are constructed of copper to provide low-loss operation. Such construction also assures

adequate heat removal for power dissipated as a result of RF losses and intercepted beam current. The coolant passages for the slow-wave structure surround the cavities.

Straightforward mechanical design of the electron gun assures positive alignment of the various components within the tube, even when subjected to severe shock and vibration. Conservative design of the cathode has been accomplished to provide long-term operating life. The cathode is an impregnated dispenser type operating at 700 mA/cm^2 .

Focusing of the electron beam is done by a WJ-SL9 focusing solenoid which provides the necessary straight magnetic field. The WJ-SL9 was specifically designed for use with the WJ-341 TWT amplifier. Mounting attachments for the amplifier are contained within the solenoid core as shown in Figure 1. Transfer of heat away from the amplifier is aided by the integral coolant passages of the solenoid.

A typical power output curve is shown in Figure 2. Performance of the WJ-341 can be altered somewhat by operating at different voltages within the ranges shown on the attached Tentative Specification sheet.

Typical connections to the WJ-341 are shown in the diagram of Figure 3.

Additional information may be obtained through our representative in your area, or by contacting Watkins-Johnson Company, 3333 Hillview Avenue, Palo Alto, California. Inquiries to our Palo Alto facility should be addressed to the attention of Applications Engineering.

TENTATIVE SPECIFICATION

WJ-341

5.3 TO 6.0 GHZ 1.0 KW CW TRAVELING-WAVE-TUBE AMPLIFIER (SOLENOID FOCUSED)

PERFORMANCE

	<u>Typical</u>	<u>Guaranteed</u>
Frequency	5.3 - 6.0 GHz	5.45 - 5.85 GHz
Power output	1.30 kW CW	1.25 kW CW, min.
Gain	11 dB	10 dB, min.
VSWR, input or output	1.5:1	1.8:1, max.

ELECTRICAL REQUIREMENTS

	<u>Typical</u>	<u>Range</u> ¹
Cathode voltage	13.5 kV dc	13.0 - 14.0 kV dc
Cathode current	1.0 A	0.9 - 1.2 A
Circuit voltage	Grounded	Grounded
Circuit current	15 mA	5 - 50 mA
Collector voltage	Grounded	Grounded
Collector current	0.985 A	0.9 - 1.2 A
Filament voltage	12.0 V	10.0 - 14.0 V
Filament current	3.0 A	2.5 - 3.5 A
Solenoid voltage	45 V	40 - 50 V
Solenoid current	11.5 A	10 - 13 A

ENVIRONMENTAL CHARACTERISTICS

Temperature	0° - 50° C
Vibration, 0.10 inch, double amplitude	2 g, 1 - 33 c/s
Shock	2 g, 11 ms

MECHANICAL CHARACTERISTICS

Tube diameter (excluding connectors)	3.0 inches, max.
Tube length	24.0 inches, max.
Solenoid diameter (excluding water fittings & output connector)	8.0 inches, max.

MECHANICAL CHARACTERISTICS (continued)

Solenoid length (excluding input jack)	8.5 inches, max.
RF input connector	Type N, jack
RF output connector (waveguide flange)	UG-149/U
Coolant flow rates (water and ethylene glycol) ²	
Solenoid	1 gal/min
Circuit	1 gal/min
Collector	10 gal/min @
	20 lbs/in ²
Weight (including solenoid)	52 lbs, max.

¹Values in this column indicate minimum and maximum values for satisfactory operation of WJ-341 amplifier. Cathode voltage must be maintained within $\pm 1.0\%$, filament voltage within $\pm 5.0\%$, and solenoid current within $\pm 5.0\%$ of the values specified on the final data sheet(s) for each tube.

²Values are for CW operation and an inlet temperature of 140^oF.

WATKINS-JOHNSON COMPANY
Stanford Industrial Park
3333 Hillview Avenue
Palo Alto, California

Telephone: (415) 326-8830
Teletype: (910) 373-1253

December 1965

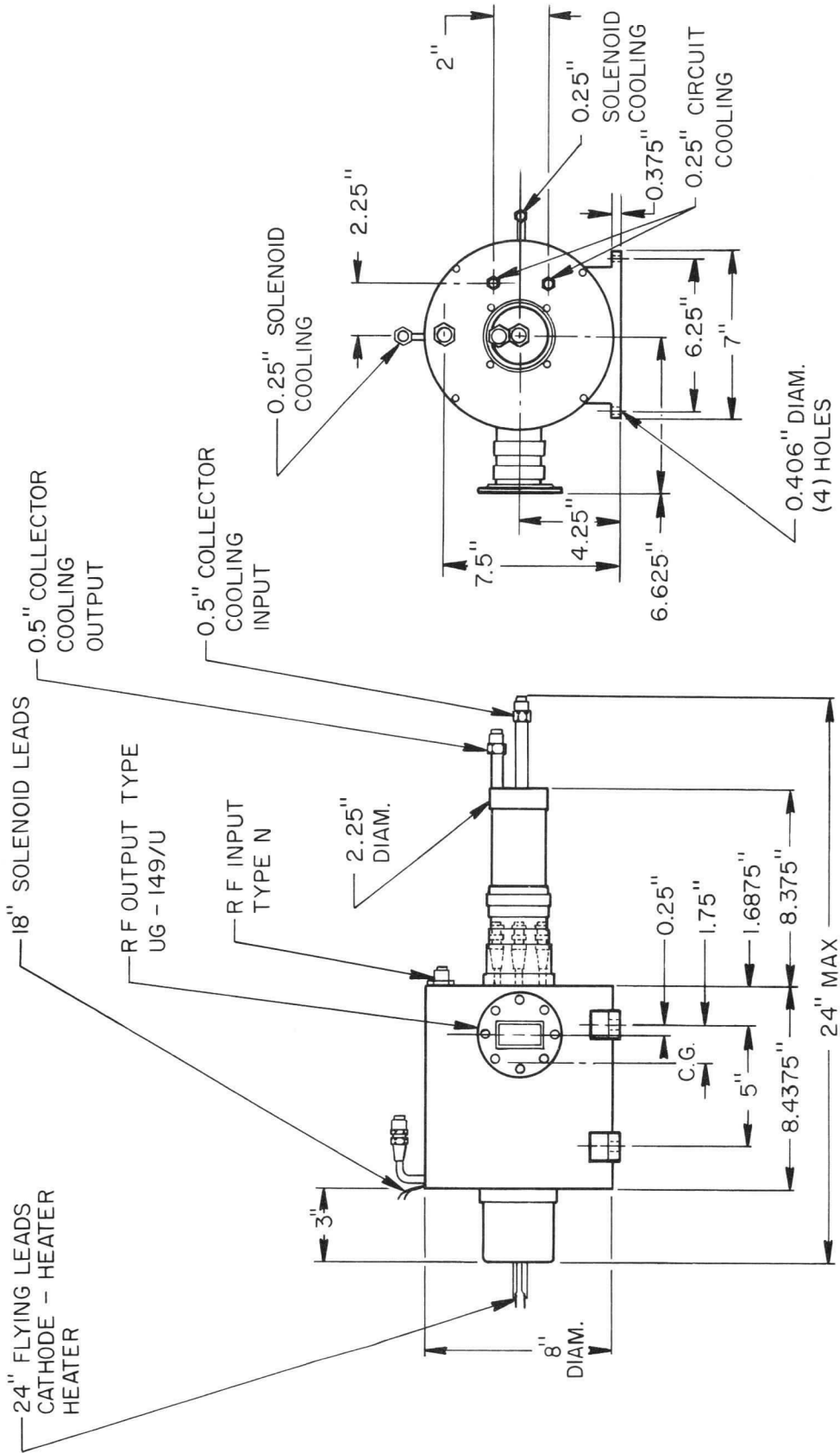

FIG. I. WJ - 341 MOUNTING ATTACHMENTS

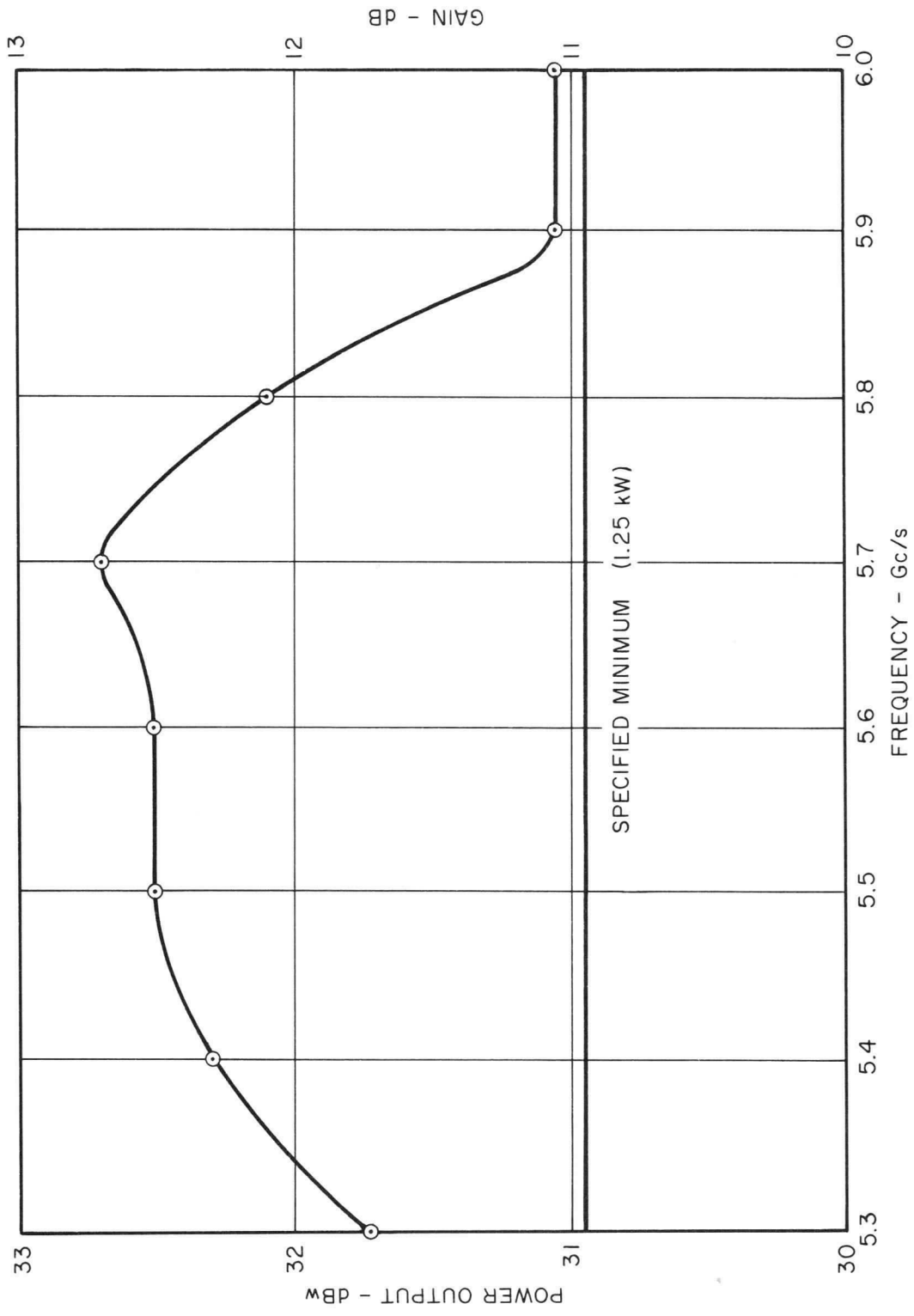

FIG. 2. WJ - 341 TYPICAL POWER OUTPUT

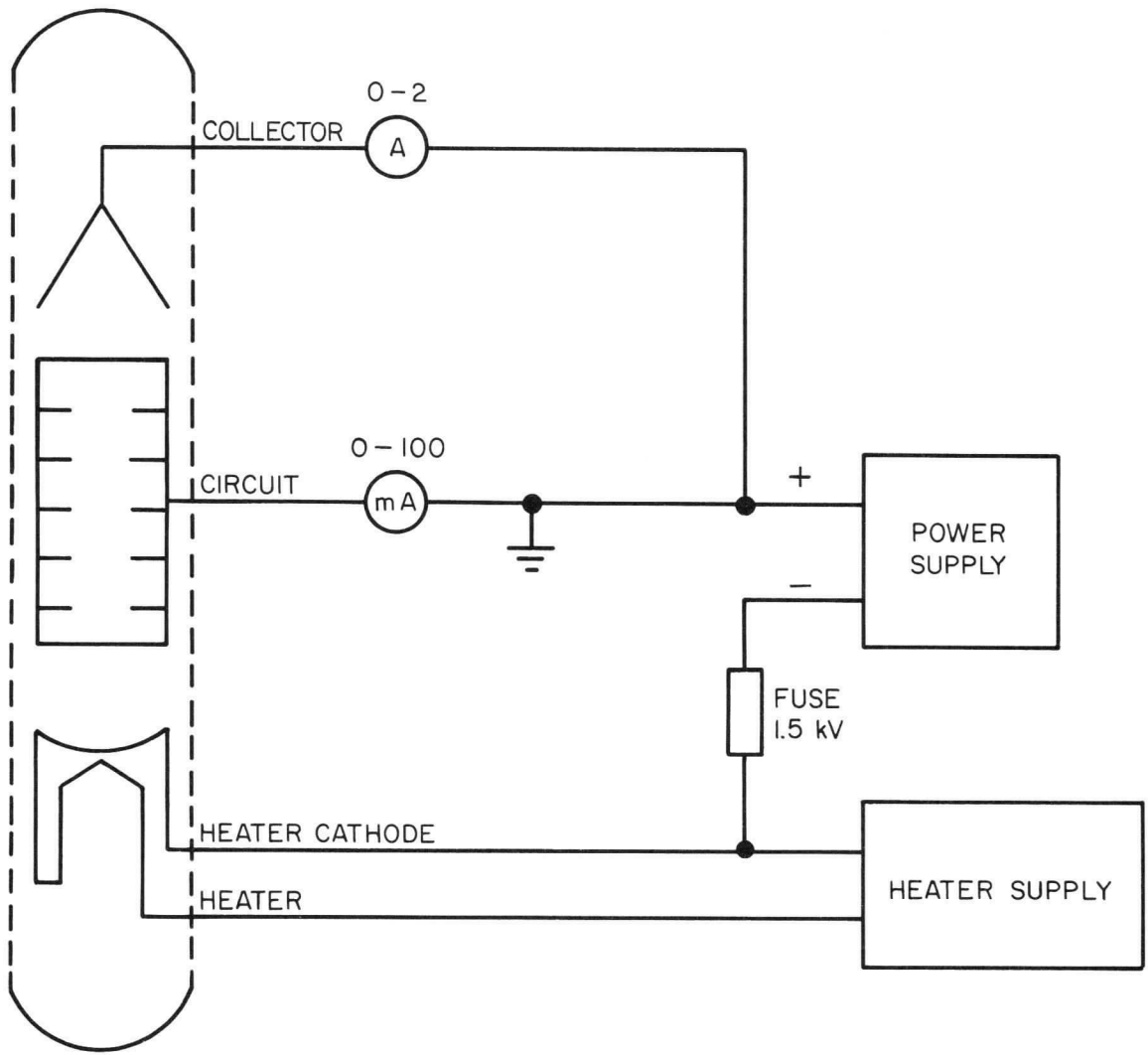

FIG. 3. WJ-341 TYPICAL POWER SUPPLY CONNECTIONS

ELECTRONICALLY TUNABLE FILTERS

QUICK
REFERENCE
CATALOG

March / 1965

YIG FILTERS

WATKINS | JOHNSON COMPANY



TYPE NUMBER (b)	RF PERFORMANCE							
	Tuning Range (Gc)	Off-resonance Isolation (db)	Directivity	Spurious Response (db)	Passband Ripple (db)	VSWR Input & Output	Limiting Level (dbm)	Selectivity (per 3 db bandwidth octave)
WJ-548	1.0- 2.0	60	reciprocal	- 25	1.0	1.5	- 18 (a)	12 db
WJ-549	2.0- 4.0	60	reciprocal	- 25	1.0	1.5	- 18 (a)	12 db
WJ-550	4.0- 8.0	60	reciprocal	- 25	1.0	1.5	+ 10	12 db
WJ-551	8.0-12.4	60	reciprocal	- 25	1.0	1.5	+ 10	12 db
WJ-552	8.0-12.4	50	30 db	- 25	1.0	1.5	+ 10	12 db
WJ-553	12.4-18.0	50	30 db	- 25	1.0	1.5	+ 10	12 db
WJ-560	1.0- 2.0	30	reciprocal	- 15	1.0	1.5	- 18 (a)	6 db
WJ-561	2.0- 4.0	30	reciprocal	- 15	1.0	1.5	- 18 (a)	6 db
WJ-562	4.0- 8.0	30	reciprocal	- 15	1.0	1.5	+ 10	6 db
WJ-563	8.0-12.0	30	reciprocal	- 15	1.0	1.5	+ 10	6 db

(a) + 10 dbm has been achieved in units with higher insertion loss.
 (b) Complete type number includes bandwidth suffix.

TYPICAL INSERTION LOSS vs 3 db BANDWIDTH
 WJ-549 (2 stage, S-band)

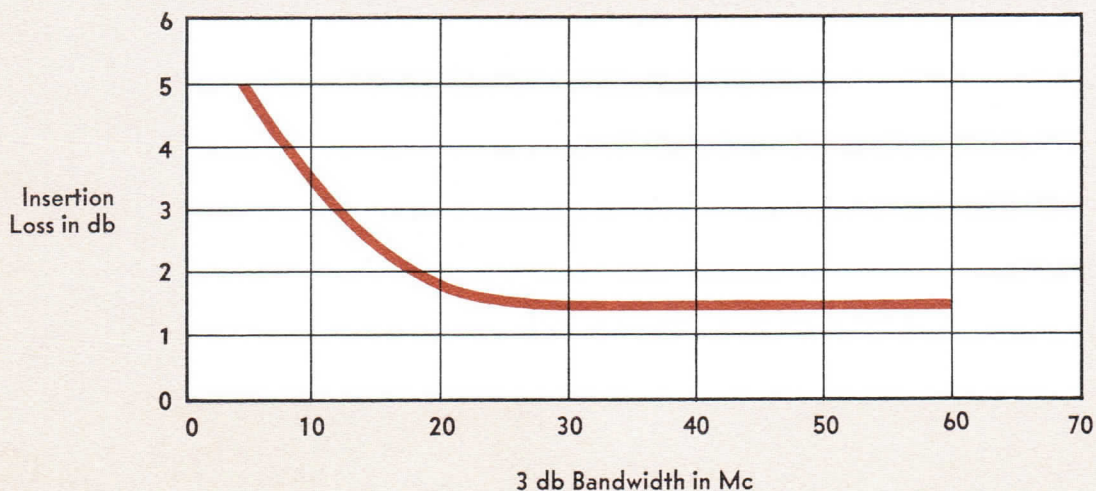

TYPICAL SPECIFICATIONS

TUNING CHARACTERISTICS							MECHANICAL		
Sensitivity (mc/ma)	Coil Resistance (ohms)	Coil Inductance (mh)	Tuning Time Constant (milli-seconds)	Deviation from Linear	Hysteresis	Temp. Coefficient (kc/oc)	Size (excluding connectors)	Weight	R.F. Conn.**
2.6	2	8.5	0.2	0.1%	0.1%	100	3.1" x 2.6" x 2.8"	25 oz.	Type N
2.6	2	8.5	0.2	0.15%	0.1%	100	3.1" x 2.6" x 2.8"	25 oz.	Type N
3.0	2	8.5	0.2	0.2%	0.1%	150	3.1" x 2.6" x 2.8"	25 oz.	Type N
3.0	2	8.5	0.2	0.4%	0.15%	150	3.1" x 2.6" x 2.8"	25 oz.	TNC
3.0	2	8.0	2.0	0.2%	0.1%	150	4.4" x 4.8" x 3.2"	4 lb.	UG39/u
3.0	2	8.0	2.0	0.25%	0.15%	150	4.4" x 4.8" x 3.2"	4 lb.	UG419/u
2.6	2	8.5	0.2	0.1%	0.1%	100	3.1" x 2.6" x 2.3"	25 oz.	N
2.6	2	8.5	0.2	0.15%	0.1%	100	3.1" x 2.6" x 2.3"	25 oz.	N
3.0	2	8.5	0.2	0.2%	0.1%	150	3.1" x 2.6" x 2.3"	25 oz.	N
3.0	2	8.5	0.2	0.4%	0.15%	150	3.1" x 2.6" x 2.3"	25 oz.	TNC

** TNC connectors available at no extra cost on all coaxial units.

OUTLINE—WJ-549
Showing Electrical Connections

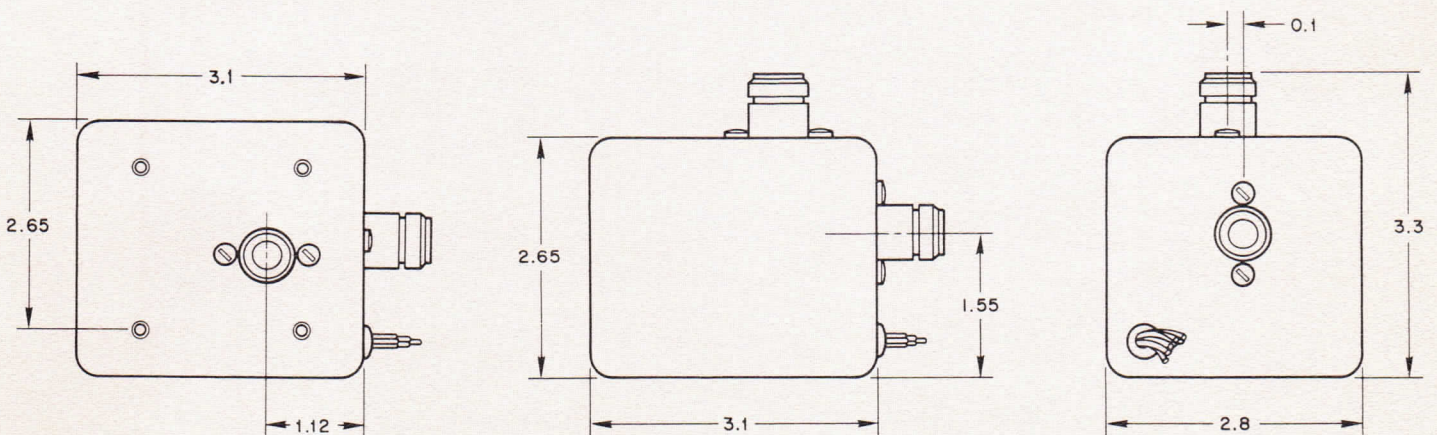

YIG FILTERS WITH INTEGRAL DRIVERS

TYPE	RF Performance Similar to WJ Type	CASE I			CASE II			SIZE *	WEIGHT
		CONTROL SIGNAL ²		Power Requirements	CONTROL SIGNAL ²		Power Requirements		
		Voltage ¹	Input Impedance		Voltage ¹	Input Impedance			
WJ-581	WJ-548	2-8 V	1 meg Ω	20 VDC @ 1 amp, 0.5% — 15 VDC @ 10 ma, 0.5%	2-8 V	10 k Ω	25 VDC @ 1 amp, 0.5%	3" x 2.8" x 4.25"	34 oz.
WJ-582	WJ-549	2-8 V	1 meg Ω	20 VDC @ 1 amp, 0.5% — 15 VDC @ 10 ma, 0.5%	2-8 V	10 k Ω	25 VDC @ 1 amp, 0.5%	3" x 2.8" x 4.25"	34 oz.
WJ-583	WJ-550	2-8 V	1 meg Ω	20 VDC @ 1 amp, 0.5% — 15 VDC @ 10 ma, 0.5%	2-8 V	10 k Ω	25 VDC @ 1 amp, 0.5%	3" x 2.8" x 4.25"	34 oz.
WJ-584	WJ-551	2-8 V	1 meg Ω	20 VDC @ 1 amp, 0.5% — 15 VDC @ 10 ma, 0.5%	2-8 V	10 k Ω	25 VDC @ 1 amp, 0.5%	3" x 2.8" x 4.25"	34 oz.

¹ Voltage range easily modified.

² DC to 100 cps ramp. Control voltage to r.f. frequency linearity 0.1%.

* Includes cooling fins. If conduction cooled, 4.25" dimension will be 3.25".

ADDITIONAL ADVANTAGES:

- Temperature control capability optional
- Faster switching available
- All units now magnetically shielded
- Militarized for rugged environments
- Repeatability of performance is guaranteed by virtue of the largest manufacturing capability of its kind in the world
- All the long-life capability of a quality-engineered passive solid-state device
- Units may be cascaded for additional selectivity

THE WATKINS-JOHNSON YIG CAPABILITY

In W-J's Solid State Laboratories, the standard units listed herein are under constant re-evaluation and development leading to even more useful and reliable devices.

The frequency selective limiting characteristic of YIG and YIG-type materials is being used to manufacture limiters for such applications as receiver anti-jam protectors.

The extremely linear tuning characteristics of the YIG make it useful as a tuning element not only in filters but also in such devices as parametric amplifiers, transistor oscillators, tunnel diode amplifiers and oscillators, and multipliers. Several of these devices can be tuned over octave bands by a single control voltage with little or no tracking error, even when substantial frequency off-sets are required between units in the system.

W-J solicits the opportunity of reviewing your technical requirements. We may have the solution, through a sound and conservative engineering approach to all delineated problems!

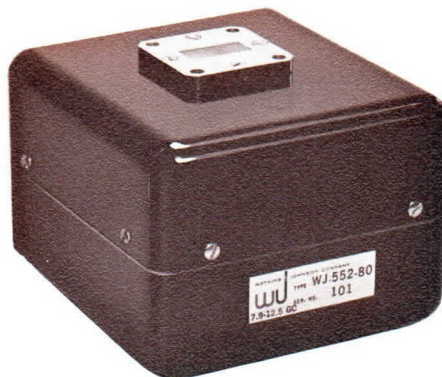
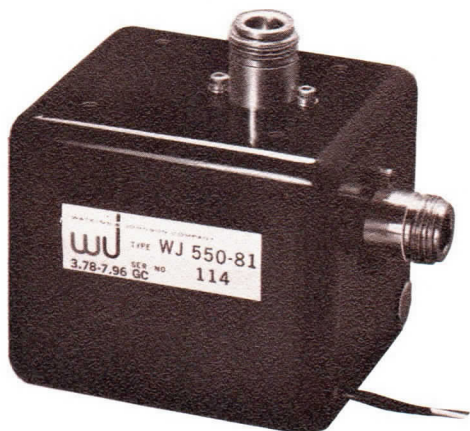



WATKINS-JOHNSON COMPANY was formed in December, 1957, to engage in research, development, and production of advanced electron devices and related electronic systems and equipments. It now occupies a 23-acre site in Stanford Industrial Park, adjacent to Stanford University, and the 30-acre site of its Stewart Division, near Santa Cruz, California. A major financial interest is owned by the Kern County Land Company, a major diversified organization incorporated in 1890.

Watkins-Johnson is deeply involved in advancing the state of the art in the fields of microwave electron-beam and solid-state devices, as well as optical-frequency devices. Programs range from low-noise to high-power and cover frequencies from 250 Mc through visible light. Production of low-noise traveling-wave tubes, YIG filters, medium-power traveling-wave tubes, and backward-wave oscillators accounts for a large part of the company's manufacturing effort.

NORTHWEST	Rush S. Drake Associates, Inc. 6133 Maynard Avenue South Seattle (Tel. 206-PA5-2700)	Eastern Instrumentation, Inc. 350 Northern Boulevard Great Neck, L.I. (Tel. 516-466-9505) 613 Cheltenham Avenue Philadelphia (Tel. 215-WA7-6269) 1002 Ingleside Avenue Baltimore (Tel. 301-RI4-3675)	EAST
WEST	Applications Engineering Watkins-Johnson Company 3333 Hillview Avenue Palo Alto (Tel. 415-326-8830)		
	Bennewitz Associates 8310 Cutler NE Albuquerque (Tel. 299-8651)	Ossmann Instruments, Inc. 3100 Monroe Avenue Rochester (Tel. 716-LU6-0380) 101 Pickard Drive Syracuse (Tel. 315-GL4-2461) Vestal Parkway East Vestal, N.Y. (Tel. 607-ST5-9947)	
SOUTHWEST	Kemco, Inc. 11520 Burdine Houston (Tel. 713-MO7-1409) P.O. Box 998 Irving, Texas (Tel. 214-BL3-6703)	M. J. McDonald Co., Inc. 310 West Third Street Burlington, N.C. (Tel. 919-226-7177) 2610 Seabreeze Court Orlando (Tel. 305-422-0039) Route No. 1 Pfafftown, N.C. (Tel. 919-924-2182) 1000 Airport Road, F-8 Huntsville, Ala. (Tel. 205-881-5043)	SOUTHEAST AND SOUTH
MIDWEST	Kemco, Inc. 6115 E. 13th Wichita, Kansas (Tel. 316-MU4-8224)		
	Scientific Sales Co. 7132 N. Harlem Avenue Chicago (Tel. 312-775-7595) 24 Pheasant Lane St. Paul (Tel. 612-484-8022)	Maurice I. Parisier Co. 741-745 Washington Street New York (Tel. 212-AL5-8900)	
	S. Sterling Co. 21250 10 1/2 Mile Road Southfield, Mich. (Tel. 313-442-5656)	Relations Techniques Intercontinentales 134 Avenue de Malakoff Paris XVI (Tel. Passy 43-09)	
NORTH CENTRAL	5827 Mayfield Road Cleveland (Tel. 216-HI2-8080)	Dale Electronics Limited 109, Jermyn Street London, SW1 (Tel. Whitehall 4856)	EXPORT
	3300 South Dixie Drive Dayton (Tel. 513-AX8-7573)	AB Nordiska Elektronik John Ericssongatan 12 to 14 Stockholm K (Tel. 08/24 83 40)	
	4232 Brownsville Road Pittsburgh (Tel. 412-TU4-5515)	A/S Nordisk Elektronik Danasvej #2 Copenhagen V (Tel. EVA 8285)	
	Lancer Associates 442 Marrett Road Lexington, Mass. (Tel. 617-VO2-7782)		

QUICK
REFERENCE
CATALOG

January / **1964**

YIG FILTERS

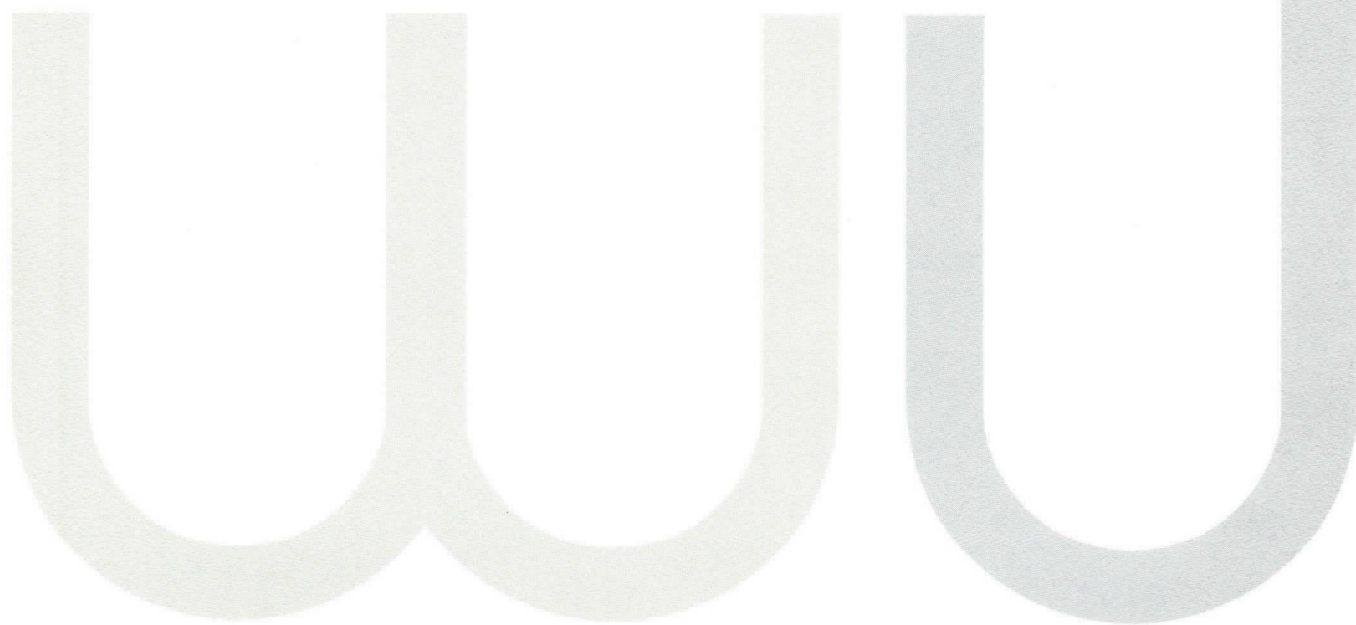

WATKINS-JOHNSON YIG

Fast, electrically tuned YIG filters are now available from 1 to 18 Gc for search-analyzer applications. If the specifications listed do not meet your requirements, your particular problem. Watkins-Johnson has also developed YIG filters for millimeter and YIG band-reject filters.

Type	Tuning Range —Gc—	Bandwidth —Mc—		Insertion Loss —db—		Off Resonance Isolation —db—		DC Tuning Power —W—		Switching Time Constant —mSec—		Selectivity db/octave
		Guar. Max.	Typical	Guar. Max.	Typical	Guar. Min.	Typical	Guar. Max.	Typical	Guar. Max.	Typical	
WJ-534	1-2	25	20	2	1	25	30	0.8	0.5	2	1	6
WJ-529	1-2	20	15	5	3	50	60	0.8	0.5	2	1	12
WJ-501-1	2-4	30	25	2	1	30	40	1.5	1.0	2	1	6
WJ-501-4	2-4	30	25	4	2	50	60	1.5	1.0	2	1	12
WJ-501-5	2-4	30	25	4	2	50	60	1.5	1.0	0.010	0.005	12
WJ-535	4-8	30	25	2	1	25	30	5	4	6	4	6
WJ-530	4-8	30	25	3	2	50	60	5	4	6	4	12
WJ-506	8.2-12.4	30	25	3	2	40	50	5	4	6	4	12
WJ-512	8.2-12.4	30	25	6	4	70	80	10	8	6	4	24
WJ-513-1	12.4-18.0	40	30	3.5	2.5	50	60	4.5	3.5	6	4	12
WJ-513	12.4-18.0	40	30	7	4.5	70	80	8	6	6	4	24

W-J YIG FILTERS CAN BE TUNED VERY RAPIDLY...THEY ARE EXTREMELY RUGGED...THEY

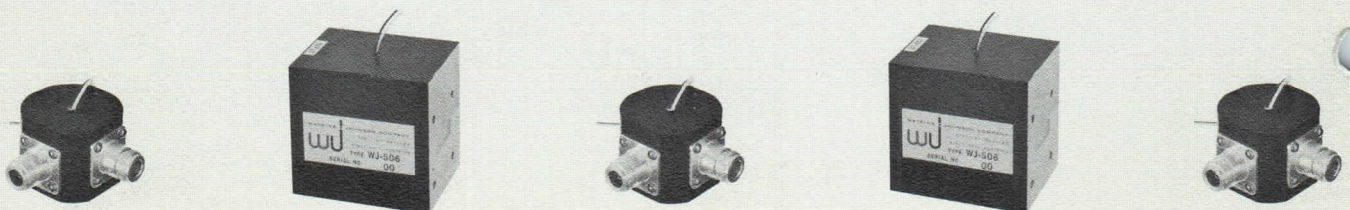

FILTERS

January 1964

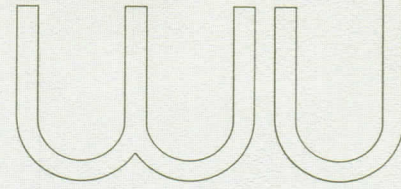

Receiver radar and spectrum-
product us for the solution to
er wavelengths, YIG limiters,

Response (No. of Stages)	Directivity —db—	Tuning Sensitivity —Mc/mA—		Frequency Resettability —Mc—		Spurious Response —db—		Passband Ripple —db—		Size —in—	Weight		
		Guar.	Typical	Guar. Max.	Typical	Guar. Min.	Typical	Guar. Max.	Typical				
One	Reciprocal	4-6	5.5	±1	±0.5	-15	-20	1	0.5	2Dx1½ L	9 oz.		
Two	Reciprocal	5-6	5.5	±1	±0.5	-20	-25	1	0.5	2Dx1½ L	9 oz.		
One	Reciprocal	5-6	5.5	±2	±1	-10	-15	1	0.5	2Dx1½ L	9 oz.		
Two	Reciprocal	5-6	5.5	±2	±1	-20	-25	1	0.5	2Dx1½ L	9 oz.		
Two	Reciprocal	0.4-1.0	0.6	±2	±1	-20	-25	1	0.5	2Dx1½ L	9 oz.		
One	Reciprocal	4-6	5.5	±5	±3	-10	-15	1	0.5	2¼ Dx1¾ L	14 oz.		
Two	Reciprocal	4-6	5.5	±5	±3	-20	-25	1	0.5	2¼ Dx1¾ L	14 oz.		
Two	Guar. Min.	20	30	5-7	5.5	±5	±3	-20	-25	1	0.5	2.1x2.6x3.0	2 lb.
	Typical												
Four	40	60	5-7	5.5	±5	±3	-40	-50	1	0.5	2.1x2.6x5.9	4 lb.	
Two	20	30	6-9	8	±7	±5	-20	-25	1	0.5	2.0x2.6x2.75	2 lb.	
Four	40	60	6-9	8	±7	±5	-40	-50	1	0.5	2.0x2.6x4.5	4 lb.	

CAN OPERATE OVER WIDE TEMPERATURE RANGE...THEY ARE SMALL AND LIGHT WEIGHT



QUICK REFERENCE CATALOG 1964 WATKINS-JOHNSON COMPANY YIG FILTERS



WATKINS-JOHNSON COMPANY was formed in December, 1957, to engage in research, development, and production of advanced electron devices and related electronic systems and equipments. It now occupies a 23-acre site in Stanford Industrial Park adjacent to Stanford University, and the 30-acre site of its subsidiary, **Stewart Engineering Company**, near Santa Cruz, California. A major financial interest is owned by the Kern County Land Company, a land and development organization incorporated in 1892 and well known in the West.

Watkins-Johnson is deeply involved in advancing the state of the art in the fields of micro-wave electron-beam and solid-state devices, as well as optical-frequency devices. Programs range from low-noise to high-power and cover frequencies from 250 Mc through visible light. Production of low-noise traveling-wave tubes, YIG filters, and medium-power traveling-wave tubes is now under way.

Starting in September, 1960, with the organization of a Systems Division, the widening base of technical activity has produced numerous sophisticated devices that have been employed at W-J as key elements in a variety of advanced equipments. Principal activities are in the fields of space communications, reconnaissance, surveillance, and countermeasures. Transmitters, power amplifiers, electronically tunable receivers, low-noise amplifiers, phase-stabilized receivers and transmitters, and ancillary equipment have been developed and delivered.

REPRESENTATIVES

WEST	Perlmuth Electronics 5057 West Washington Boulevard Los Angeles (Tel. 213-WE1-1041)	Lancer Associates 428 Marrett Road Lexington, Mass. (Tel. 617-VO2-7782)	EAST
	1285 Terra Bella Mountain View, Calif. (Tel. 415-961-2070)	Eastern Instrumentation, Inc. 350 Northern Boulevard Great Neck, L.I. (Tel. 516-466-9505)	
	8068 Engineers Road San Diego (Tel. 714-BR8-6230)	613 Cheltenham Avenue Philadelphia (Tel. 215-WA7-6269)	
SOUTHWEST	2859 East Thomas Road Phoenix (Tel. 602-AM4-4934)	808 Ingleside Avenue Baltimore (Tel. 301-RI4-3675)	SOUTHEAST AND SOUTH
	2745 San Mateo NE Albuquerque (Tel. 505-AM8-6797)	Ossmann Instruments, Inc. 3100 Monroe Avenue Rochester (Tel. 716-LU6-0380)	
MIDWEST	Kemco, Inc. 12019 Hillcroft Houston (Tel. 713-MO7-1409)	101 Pickard Drive Syracuse (Tel. 315-GL4-2461)	EXPORT
	P.O. Box 998 Irving, Texas (Tel. 214-BL3-6703)	Vestal Parkway East Vestal, N.Y. (Tel. 607-ST5-9947)	
NORTH CENTRAL	6427 East Kellogg Wichita, Kansas (Tel. 316-MU4-8224)	M. J. McDonald Co. 2610 Seabreeze Court Orlando (Tel. 305-422-0039)	EXPORT
	Scientific Sales Co. 8272 North Merrill Street Chicago (Tel. 312-825-1478)	Route No. 1 Pfafftown, N.C. (Tel. 919-924-2182)	
	S. Sterling Co. 21250 10 1/2 Mile Road Southfield, Mich. (Tel. 313-442-5656)	1000 Airport Road, F-8 Huntsville, Ala. (Tel. 205-881-5870)	
	5827 Mayfield Road Cleveland (Tel. 216-HI2-8080)	Maurice I. Parisier Co. 741-745 Washington Street New York (Tel. 212-AL5-8900)	
	3300 South Dixie Drive Dayton (Tel. 513-AX8-7573)	Relations Techniques Intercontinentales 134 Avenue de Malakoff Paris XVI (Tel. Passy 43-09)	
	4232 Brownsville Road Pittsburgh (Tel. 412-TU4-5515)		

ELECTRONICALLY-TUNABLE OSCILLATORS

TYPE	FREQUENCY RANGE	POWER OUTPUT	DC TUNING POWER	SIZE	WEIGHT	STATUS
WJ-523	1-2 Gc	50 μ w	1 w	1 1/2" Lx2" D	8 oz.	°
WJ-520	2-4 Gc	50 μ w	3 w	1 1/2" Lx2" D	8 oz.	°
WJ-524	4-6 Gc	50 μ w	3 w	1 1/2" Lx2" D	8 oz.	°
WJ-525	6-8 Gc	50 μ w	3 w	1 1/2" Lx2" D	8 oz.	°
WJ-526	8-10 Gc	50 μ w	3 w	1 1/2" Lx2" D	8 oz.	°

If none of the above devices exactly meets your specifications, we solicit your inquiry for a modification of these specifications or the development of a new device.

*Standard Catalog Item. †Under Development. °Feasibility Confirmed.

Further inquiries may be directed to Applications Engineering, or to our representative

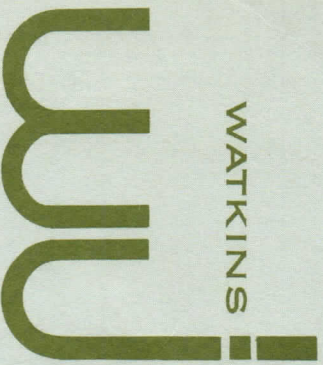

WATKINS JOHNSON COMPANY

electron devices
electronic systems

3333 HILLVIEW AVENUE
STANFORD INDUSTRIAL PARK
PALO ALTO, CALIFORNIA
(415) 326-8830

REPRESENTATIVES

- Perinuth Electronic Instrumentation**
5057 West Washington Boulevard
Los Angeles 16 (Tel. Webster 1-1041)
941 Charleston Road
Palo Alto (Tel. Davenport 1-5064)
8068 Engineers Road
San Diego (Tel. Browning 8-6230)
2859 East Thomas Road
Phoenix (Te. AMherst 4-4934)
2745 San Mateo, NE.
Albuquerque (Tel. AMherst 8-6797)
Denver (Tel. 757-3316)
Salt Lake City (Tel. ZEnith 879)
- Lancer Associates**
428 Marrett Road
Lexington 73, Mass.
(Tel. VOLunteer 2-7782)
- Edward A. Osmann & Associates**
830 Linden Avenue
Rochester 25 (Tel. LUDlow 6-4940)
101 Pickard Drive
Syracuse 11 (Tel. GLenview 4-2461)
149 Front Street
Vestal, New York (Tel. STILLwell 5-0296)
- Crossley Associates, Inc.**
2501 W. Peterson Avenue
Chicago 45, Ill. (Tel. BRoadway 5-1600)
- 2801 Far Hills Avenue
Dayton 19, Ohio (Tel. AXminster 9-3594)
3919 Meadows Drive
Indianapolis 5, Ind. (Tel. LLiberty 6-4891)
842 Raymond Avenue
St. Paul 14, Minn. (Tel. MIDway 6-7881)
- Eastern Instrumentation, Inc.**
613 Cheltenham Avenue
Philadelphia 26 (Tel. WAvenly 7-6269)
350 Northern Boulevard
Great Neck, Long Island (Tel. 466-9505)
808 Ingleaside Avenue
Baltimore 28, Md.
(Tel. RIDgeway 4-3675)
Silver Spring, Md. (Tel. JUniper 9-0100)
- EXPORT**
- Maurice I. Parisier & Co.**
741-745 Washington Street
New York 14
(Tel. ALgonquin 5-8900/5-8901)
- Relations Techniques Intercontinentales**
134 Avenue Malakoff
Paris 16, France
(Tel. Passy 08-36 and Kieber 54-82)

ELECTRONICALLY-TUNABLE BAND PASS FILTERS

TYPE	TUNING RANGE	Number of Channels	BAND WIDTH	INSERTION LOSS	RESONANCE ISOLATION	DC TUNING POWER	Switching Time, Sec.	SIZE	WEIGHT	TUNING SENSITIVITY	SELECTIVITY	Directivity	Status
WJ-509	1-2 Gc	1	30 Mc	3 db	>50 db	2 w	10-3	2" x2" x3 1/2"	3 lb.		24 db/oct.	>20 db	+
WJ-509-1	1-2 Gc	1	30 Mc	2 db	>40 db	2 w	10-3	2" x2" x2"	1.5 lb.		12 db/oct.	>20 db	+
WJ-501	2-4 Gc	1	12-25 Mc	2 db-0.5 db	>40 db	3 w	10-3	2 1/8" Lx2 3/4" D	1.8 lb.	2.5 Mc/ma	6 db/oct.	Recip.	*
WJ-501-1	2-4 Gc	1	<25 Mc	1.5 db	>40 db	0.5 w	10-1	1 1/2" Lx2" D	0.8 lb.		6 db/oct.	Recip.	*
WJ-501-2	2-4 Gc	1	20 Mc	2 db	>70 db	5 w	10-3	2 1/8" Lx2 3/4" D	1.8 lb.		6 db/oct.	Recip.	+
WJ-501-3	2-7.3.7 Gc	1	<10 Mc	3 db	>40 db	1 w	10-3	2 1/8" Lx2 3/4" D	1.8 lb.	2.5 Mc/ma	6 db/oct.	Recip.	*
WJ-510	2-4 Gc	1	30 Mc	3 db	>50 db	4 w	10-3	2" x2" x3 1/2"	3 lb.		24 db/oct.	>20 db	+
WJ-510-1	2-4 Gc	1	30 Mc	2 db	>40 db	2 w	10-3	2" x2" x2"	1.5 lb.		12 db/oct.	>20 db	+
WJ-505	5.4-5.9 Gc	1	25 Mc	2-3 db	>30 db	2 w	10-6	2 1/8" Lx2 3/4" D	1.8 lb.	2 ma/Mc	6 db/oct.	Recip.	*
WJ-505-1	5.4-5.9 Gc	1	3 Mc	10 db	>50 db	2 w	10-6	1 1/2" Lx2" D	8 oz.	2 ma/Mc	6 db/oct.	Recip.	+
WJ-511	4-8 Gc	1	30 Mc	3 db	>50 db	8 w	10-3	2" x2" x3 1/2"	3 lb.		24 db/oct.	>20 db	+
WJ-511-1	4-8 Gc	1	30 Mc	2 db	>40 db	8 w	10-3	2" x2" x2"	1.5 lb.		12 db/oct.	>20 db	+
WJ-508	7-10 Gc	20	50 Mc (ea.)	3 db	>50 db	3 w/1.5 Gc tuning (ea.)	10-3	2.1" x2.4" x2.4"	16 lb.		12 db/oct. (ea.)	>20 db	+
WJ-508-1	7-10 Gc	3	30 Mc (ea.)	2 db	>50 db	3 w (each)	10-3	2.1" x2.2" x6"	3 lb.		12 db/oct. (ea.)	>20 db	+
WJ-506	8.2-12.4 Gc	1	30 Mc	2 db	>60 db	5 w	10-3	2.1" x2.6" x2.8"	1.6 lb.		12 db/oct.	>20 db	*
WJ-512	8.2-12.4 Gc	1	30 Mc	3 db	>50 db	10 w	10-3	2.1" x2.6" x4.2"	3 lb.		24 db/oct.	>20 db	+
WJ-513	12-18 Gc	1	30 Mc	3 db	>50 db	10 w	10-3	2.1" x2.6" x4"	3 lb.		24 db/oct.	>20 db	+
WJ-521	18-26 Gc	1	50 Mc	2 db	>50 db	8 w	10-3	2.1" x2.6" x2.8"	1.5 lb.		12 db/oct.	>20 db	+
WJ-522	26-40 Gc	1	50 Mc	2 db	>50 db	10 w	10-3	2.1" x2.6" x2.8"	1.5 lb.		12 db/oct.	>20 db	+
WJ-502	70-85 Gc	1	200 Mc	2 db	>60 db	20 w	10-3	2" Lx3 1/2" D	4 lb.		12 db/oct.	Recip.	+

ELECTRONICALLY-TUNABLE BAND REJECT FILTERS

TYPE	TUNING RANGE	Number of Channels	BAND WIDTH	INSERTION LOSS	REJECTION (20dbm input)	DC TUNING POWER	TUNING SENSITIVITY	SIZE	WEIGHT	Directivity	Status
WJ-514	1-2 Gc	1	30 Mc	0.2 db	50 db	2 w		2" x2" x3 1/2"	3 lb.	>20 db	+
WJ-503	2-4.3 Gc	1	<20 Mc	0.2 db	>30 db	2 1/4 w	2 Mc/ma	3.2" x2.6" x1.5"	1.2 lb.	Recip.	*
WJ-515	2-4 Gc	1	30 Mc	0.2 db	50 db	4 w		2" x2" x3 1/2"	3 lb.	>20 db	+
WJ-518	2-4 Gc	4	30 Mc (ea.)	0.5 db	50 db (ea.)	4 w (each)		2" x2" x12"	10 lb.	>20 db	+
WJ-516	4-8 Gc	1	30 Mc	0.2 db	50 db	8 w		2" x2" x3 1/2"	3 lb.	>20 db	+
WJ-517	8.2-12.4 Gc	1	30 Mc	0.2 db	50 db	8 w		2.1" x2.6" x4.5"	3 lb.	>20 db	+

FREQUENCY-SELECTIVE LIMITERS

TYPE	FREQUENCY RANGE	LIMITING INPUT	LIMITING RANGE	BAND WIDTH	INSERTION LOSS	SIZE	Status
WJ-507-1	4-7.5 Gc	1 mw	>20 db	75 Mc	<4 db	2 1/8" Lx2 3/4" D	2 lb.
WJ-507-2	4-7.5 Gc	1 mw	>20 db	200 Mc	<2 db	2 1/8" Lx2 3/4" D	2 lb.
WJ-507-3	4-7.5 Gc	1 mw	>20 db	500 Mc	<1 db	2 1/8" Lx2 3/4" D	2 lb.
WJ-519	4.5-6.5 Gc	1 mw	>20 db	500 Mc	1 db	1 1/2" Lx2" D	10 oz.

* Standard Catalog Item.

+ Under Development.

° Feasibility Confirmed.



Vol. 6, No. 4; March, 1964

THE WJ-135 SERIES

CONTROLS FOR ELECTRICALLY-TUNED YIG DEVICES

Introduction

Electrically-tuned solid-state devices such as the YIG filter, YIG-tuned tunnel diode oscillator, and the YIG-tuned parametric amplifier all require a precisely controlled magnetic field for wide-band tuning. This magnetic field is provided by the combination of a permanent bias magnet and a tuning solenoid, in a single magnetic circuit. The bias magnet tunes the YIG device to the center of the band and thereby minimizes the solenoid power required to tune over wide bandwidths.

As a result of this basic design of the YIG devices, bi-directional tuning current is necessary. This control current is obtained by means of a complementary-symmetry power transistor driver. For convenience in control and operation of this driving amplifier, circuitry has been designed around the basic power amplifier to provide a fully direct-coupled operational power amplifier. This basic and different control problem has been solved by the amplifier design described in this text. In addition, specially designed sweep generator circuits are described. The sweep circuit is unique since it too is direct coupled and is therefore capable of slow as well as fast sweep rates. The sweep characteristics of the YIG devices require a recovery period at the end of the sweeping ramp and the necessary delay multivibrator, gate, and sweep start trigger are discussed.

The operational amplifier approach to the basic control problem makes the tracking of two or more electrically-tuned YIG devices feasible. By proper adjustment of input voltages at the amplifier summing network **several control functions are possible:** tracking of two or more filters from a single input voltage, tracking with frequency offset for simultaneous operation of two or more filters in different bands, tracking with frequency offset of a YIG-tuned tunnel diode oscillator and a YIG preselector in a superheterodyne receiver, and similar combinations needed for systems utilization of YIG devices. Additional techniques have been devised and proven in practice for compensation of second-order nonlinearities in the devices themselves, as well as for magnetic circuit interaction between miniaturized multi-stage YIG-tuned devices.

Direct-Coupled Operational Control Amplifier

The basic control amplifier consists of an output power amplifier in cascade with a differential voltage comparator. The complete control amplifier is shown in Fig. 1. The power amplifier is a direct-coupled, complementary-symmetry emitter follower which is arranged to deliver bi-directional output current to the YIG device solenoid. This amplifier is compensated in such a way that both transistors are in the "on" condition at all times so that crossover distortion and "dead band" are eliminated. The current from the YIG device is returned to ground through a current measuring resistor to produce a feedback voltage at the input. The direct-coupled, differential comparator amplifier acts in such a way as to sense this feedback voltage and make it always equal to and of the same polarity as the total input to the summing network. Overall, then, this is a true "operational" amplifier which behaves simply as a transconductance. For any chosen value of input voltage, the output current is a constant value determined by the stable, current measuring resistor in the feedback loop. For example, referring again to Fig. 1, if a YIG filter such as the WJ-501-1 has a tuning constant of 5.0 Mc/ma, then making the feedback resistor exactly 5.0 ohms sets the amplifier transconductance at precisely 200 ma/volt. The overall result is that an input change to the system of 1 volt moves the bandpass of the filter 1 Gc. All that is necessary is to set the proper dc level at the input and to add the sweep or other modulating voltages at the summing network.

A useful facility is provided to obtain a positive output voltage numerically equal to the filter frequency in Gc. As shown in Fig. 1, a zener diode and potentiometer are connected to the feedback resistor and this in turn is driven by a constant current generator. The voltage across the feedback resistor is directly proportional to the frequency of the device, but is set to change, typically, from -1 volt to +1 volt as the device is tuned from 2.0 Gc to 4.0 Gc respectively. Adding a positive voltage to this gives the direct readout of frequency in volts.

Sweep Generator and Display Circuits

The type of modulation most often employed in sweeping these devices is the linear ramp function. Certain control functions are specifically required by the nature of the YIG devices. For optimum performance a special ramp generator has been perfected and is described here in further detail.

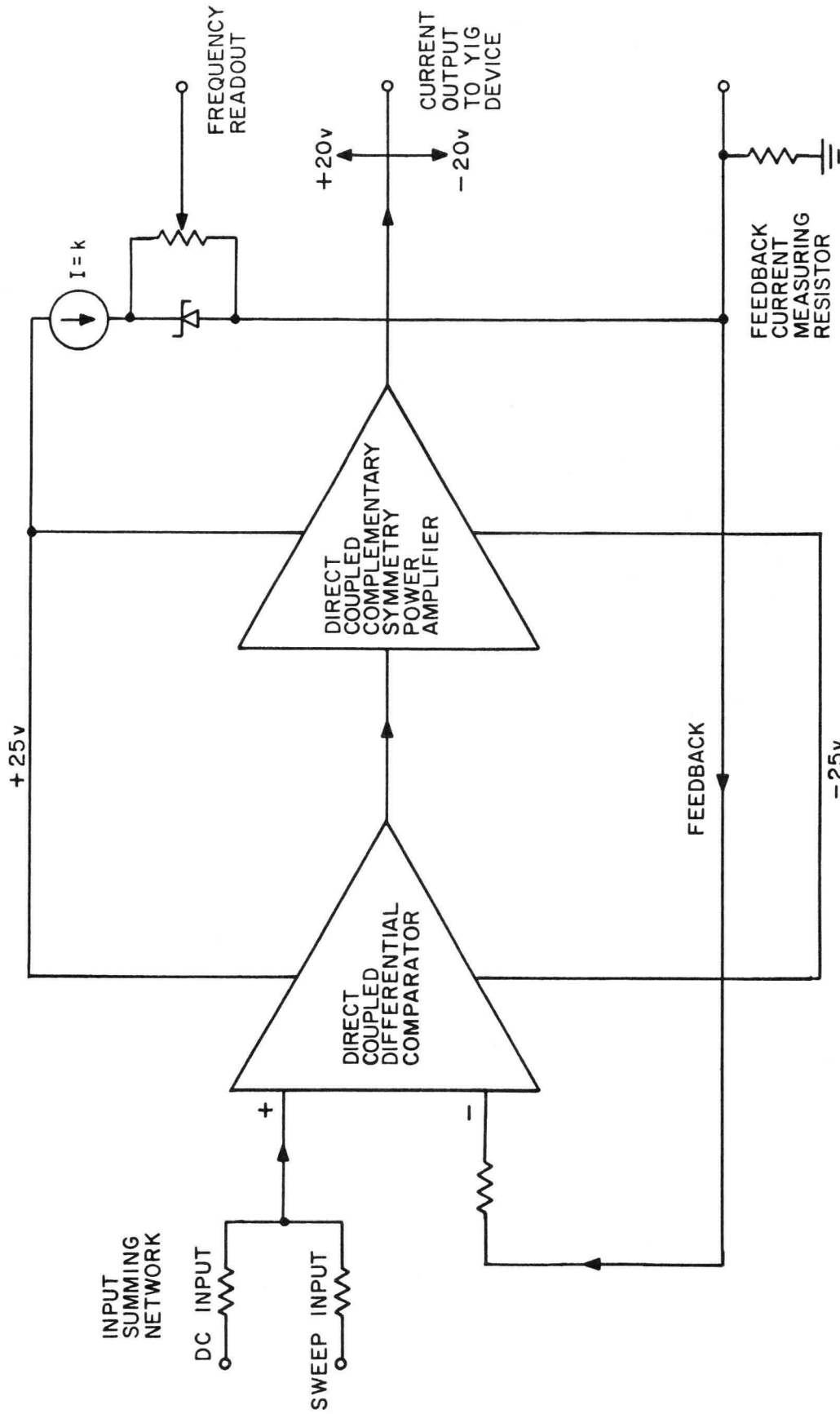

FIG. 1 DIRECT COUPLED OPERATIONAL CONTROL AMPLIFIER

The sweep generator must provide a voltage which linearly increases with time, followed by a fast recovery which includes a peaking function for enhanced recovery of the rf circuit of the YIG device, and simultaneous with this peaking, a delay before repeating the sweep cycle. A block diagram of the sweep circuitry is shown in Fig. 2. The basic sweep is generated by a bootstrap circuit which produces a ramp voltage by constant current charging of a capacitor. The start and stop of the sweep are controlled by a Schmitt trigger circuit which operates from feedback derived from the bootstrap. The amplitude of the sweep is controlled by the hysteresis of the Schmitt trigger which is stable with temperature. The start function triggers a one-shot multivibrator which is set to delay the start of the sweep allowing recovery of both the inductive magnetic circuit and the rf magnetic circuit. The one-shot controls the bootstrap through a switch which initiates the constant current charging of the sweep capacitor. Fast sweep recovery voltage is achieved by a switch in the stop channel to discharge the sweep capacitor.

Output circuits are provided for oscilloscope displays. A constant sweep output is derived independently of the sweep output which controls the YIG device, and this voltage may be applied directly to the external sweep of an oscilloscope. A trigger pulse at the start of each ramp is provided for synchronization, and the blanking output pulse may be used to disable display circuits during the recovery of the YIG device. Also, a special peaking circuit in the coupling between the sweep output and the control amplifier produces an overshoot of current in the device to enhance the rf recovery time.

Because of the fact that this sweep generator has been designed specifically for the modulation of YIG devices and is also fully direct coupled, a wide range of sweep rates is possible with excellent linearity. Sweeps are easily controlled to a linearity of 0.1 percent from 10 seconds to 100 per second. Functional convenience provides a variable sweep width about any center frequency in an octave band as well as the full octave band sweep.

System Applications

In addition to the basic control circuits described previously the question of tracking several devices requires discussion. If, as is true in many cases, two YIG devices behave linearly with tuning current to a typical accuracy of a few megacycles, it is a straightforward matter to operate as many control amplifiers as needed from a single dc or sweep control and thereby provide multiple tracking outputs to control several devices. These may be offset in frequency as required by the application typical of a superheterodyne receiver, multiple preselectors, simultaneous tuning over several bands, etc. All of these control functions may be obtained by combinations of resistor networks and bias inputs to the summing point of the control amplifiers.

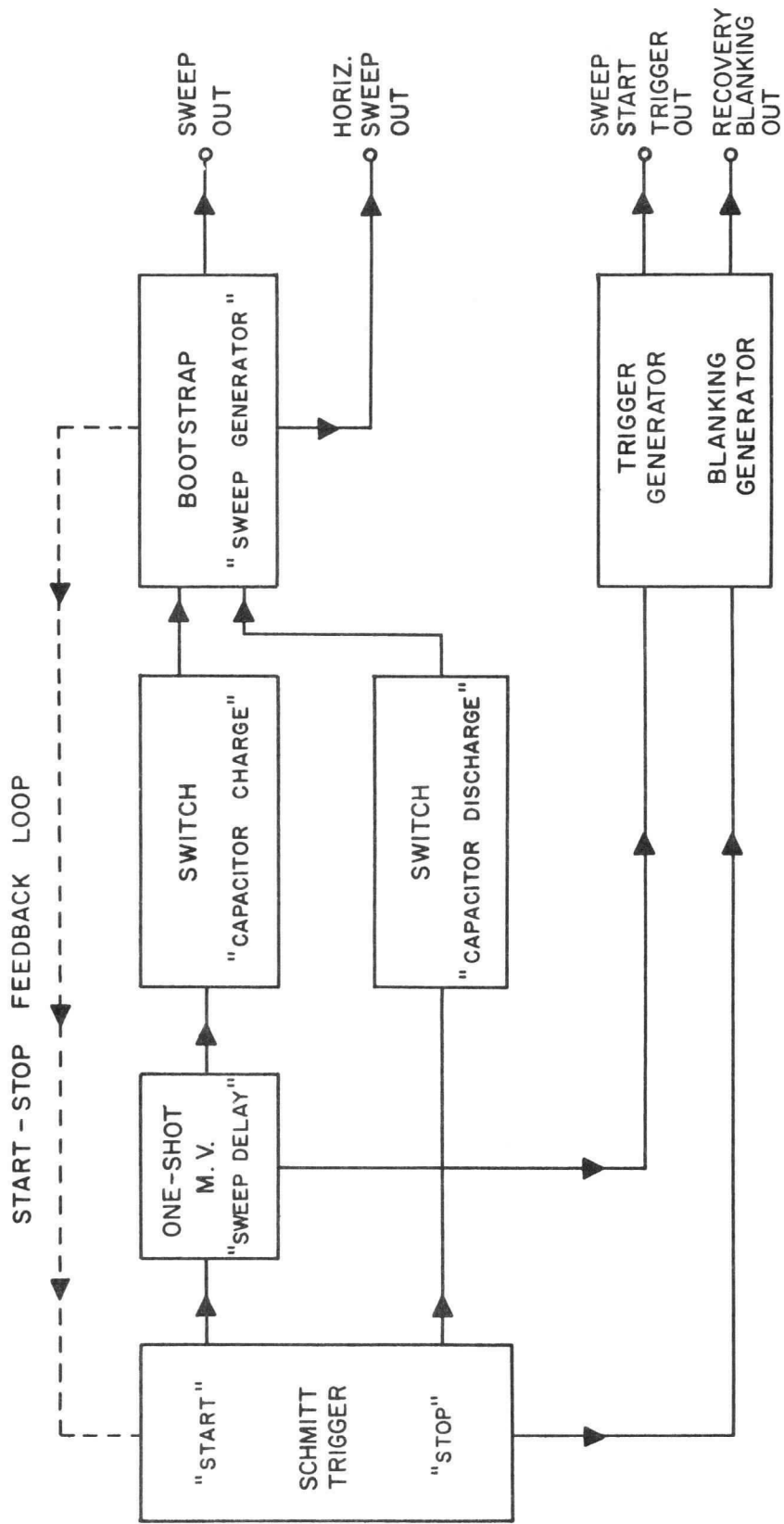

FIG. 2 BLOCK DIAGRAM OF SWEEP GENERATOR CIRCUITS

In some cases the YIG devices may exhibit nonlinearities in the order of one percent. If such is the case, tracking is more difficult to accomplish, but the problem may be conveniently solved by altering the feedback network of the control amplifier.

Nonlinearities may occur as a result of several causes: hysteresis in the magnetic circuit is one source of tracking difficulty, but this is in most cases small compared to the bandwidth (typically ± 1 Mc hysteresis at S-band) so that compensation need not be applied to the control amplifier. Magnetic circuit saturation is an effect which does often require correction in the control, especially with devices in the higher frequency ranges. A simple technique for the correction of this type of nonlinearity is shown in Fig. 3(a). Compensation may be applied at either or both ends of the band depending on the direction of the diodes. One or more correction circuits may be used if required. The diode marked (+) compensates for the positive or high frequency end of the band; the (-) for the negative or low frequency end. Other circuit connections may be used with bias or with zener diodes for sharper break points, finer control, etc.

Device nonlinearity may occur in a sense opposite to that described above and in that case shunting the device solenoid with diodes and compensating resistors may be used. In any of the cases cited above the purpose of the compensation is to reduce the system to a linear one overall, and such compensation is only required where the extremes of accuracy are desired for optimum tracking. Results with X-band filters show that with compensation a tracking accuracy of ± 5 Mc is typical.

Summary

Many of the techniques described above have been used in the WJ-135 series of controls for YIG-tuned devices. The basic circuit functions have been appropriately divided into power supply, regulator, amplifier, driver, trigger and sweep circuitry. Each functional part in turn has been designed to fit a standard 4" x 6" circuit card. By appropriate interconnection and control panel design, these building blocks have been arranged to control single filters, several devices in the same or different bands, swept crystal video receiver front ends, preselectors for use with low-noise traveling-wave tube preamplifiers, and many other device combinations. Reference to the attached Tentative Specification for the WJ-135 series is suggested, together with consultation from Watkins-Johnson Company Application Engineers on the specific needs of particular system designs.

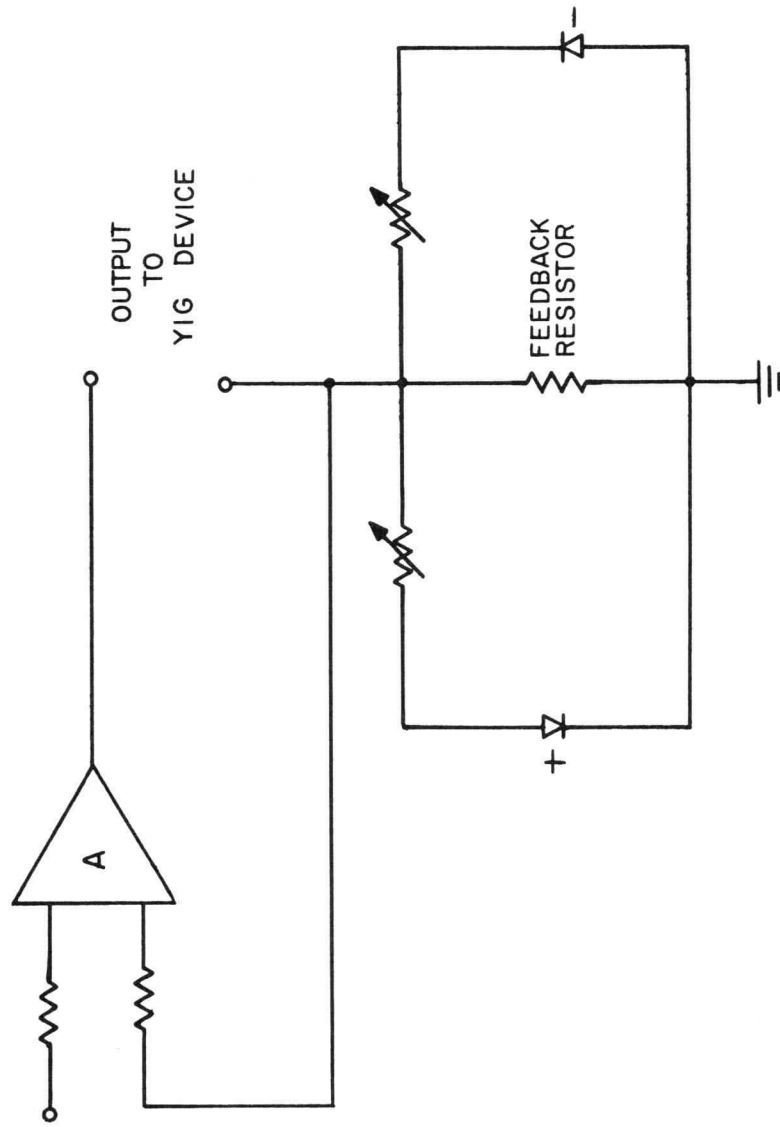

FIG. 3 TRACKING COMPENSATION — FOR MAGNETIC CIRCUIT NONLINEARITY

TENTATIVE SPECIFICATION

WJ-135 Series, Controls for Electrically Tuned YIG Devices

ELECTRICAL CHARACTERISTICS

Typical

Operational Control Amplifier

Output current	± 500 ma
Current stability	0.02 percent
Load resistance	10 - 30 ohms
Input control voltage	± 1 v
Frequency readout	+ v = Gc
dc voltages required	+ and - 25 v

Sweep Generator and Display Circuitry

Sweep rate	0.1 to 100 per sec
Sweep width	± 2 v max.
Horizontal sweep output	± 2.5 v max.
Sweep start synch output	+ 20 v, 5 μ s, max.
Blanking pulse output	+ 40 v, 2 ms
dc voltages required	+ and - 25 v

Regulated dc Power Supply

Input voltage	108 to 121 v ac
Line frequency	58 - 420 cps
Output voltages	+ and - 25 v
Output current	± 500 ma
Voltage stability	0.01 percent

ENVIRONMENTAL CHARACTERISTICS

Temperature range (operating)	-25°C to + 55°C
Altitude	0 to 50,000 ft.

TENTATIVE SPECIFICATION
(continued)

STANDARD TYPE NUMBERS AND OPTIONS AVAILABLE

<u>Type No.</u>	<u>Description</u>	<u>Purpose</u>
WJ-135-1	YIG filter sweep driver for crystal video receiver preselector	Power supply, control amplifier, and sweep generator in ATR, explosion proof package
WJ-135-2	Power supply and amplifier system for tracking L and X-band electronically tuned YIG filters	Power supply and two tracking control amplifiers for a double conversion superheterodyne receiver
WJ-135-3	Power supply and scanning generator for WJ-529-2 filter 1.0 - 2.0 Gc	Power supply, control amplifier, and sweep generator, rack mount, for RFI site surveillance
WJ-135-4	for WJ-501-1 filter 2.0 - 4.0 Gc	
WJ-135-5	for WJ-532 filter 4.0 - 8.0 Gc	
WJ-135-6	for WJ-506 filter 8.2 - 12.4 Gc	
WJ-135-7	Preselector control for two WJ-501-1 YIG filters	Power supply, and two control amplifiers with sweep generator for high image rejection superheterodyne receiver
WJ-135-8	Miniature control and sweeper for YIG filter	Power supply, control amplifier, and sweep generator in bench instrument package for laboratory use
WJ-135-9	YIG filter control	Power supply, control amplifier, and sweep generator with percent calibration for use with any WJ type YIG filter



Vol. 7, No. 2, June 1965

WJ-189 DIGITAL TUNING UNIT

- REMOTE OPERATION
- DIGITAL READOUT
- OCTAVE SCAN, SECTOR SCAN, IN DECIMAL INCREMENTS
- INFINITE HOLDING TIME
- SIGNAL LOCK-ON CAPABILITY TO ADJUSTABLE PRESET THRESHOLD
- NO MOVING PARTS
- THIN FILM AND INTEGRATED CIRCUIT CONSTRUCTION

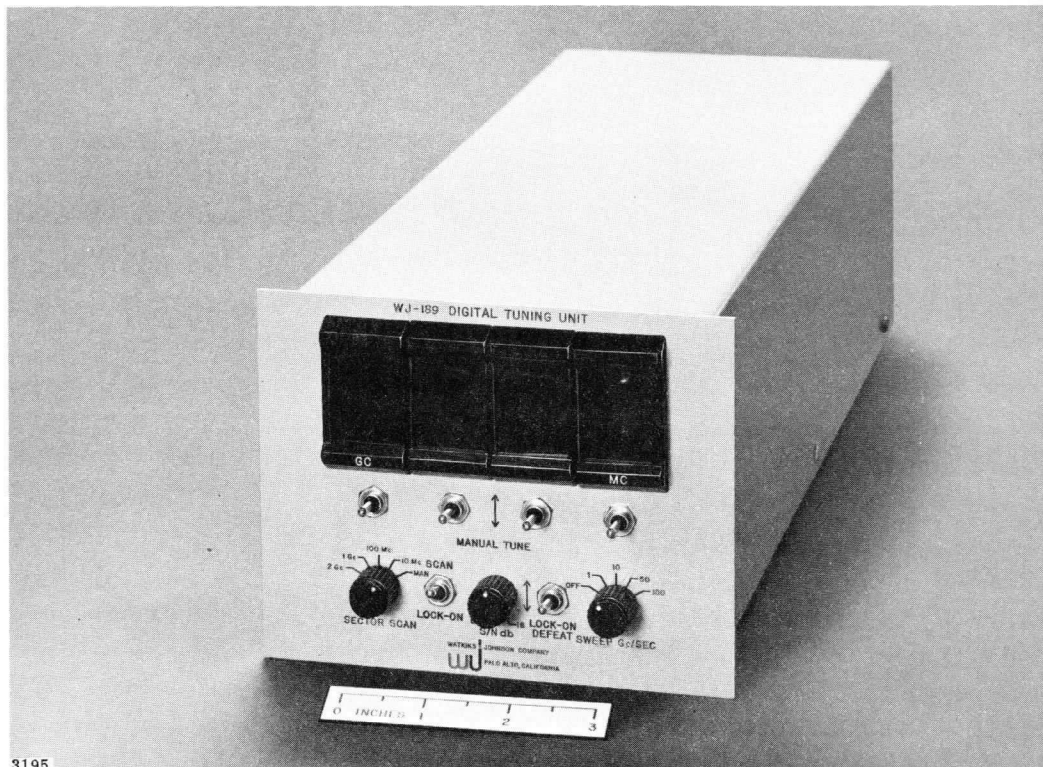

3195

The WJ-189 digital tuning unit provides precise digital control and flexibility to receiver components such as YIG preselectors, backward-wave oscillators or any voltage or current controlled tunable device. When operated in conjunction with a preselector-preamplifier tuning head, a closed loop control receiver results that is capable of performing a search-lock function for various types of signals based on a preset signal to noise threshold. Sectors of the band may be scanned 2 Gc, 1 Gc, 100 Mc or 10 Mc. portions.

Applications

1. Digital generator for driver amplifier.
2. Indicating and generating device for any sweep function
3. Driver control for voltage tuned devices, current tuned devices, YIG filters, backward-wave oscillator and VCO.
4. Digital sweep control for variable inductors and VCO.

A simplified block diagram of the digital control unit is shown in Figure 1.

The variable scan clock determines the sweep rates and is the basic sweep generator for the digital control unit. The sweep Gc/sec switch changes the sweep time within the variable scan clock. The output from the video threshold circuit, which obtains its drive from the video signal input, is coupled to the same "and" gate as the output of the variable scan clock. This signal when coupled is used to lock the digital control to that frequency as determined by the video signal in. When the video threshold is not used the variable scan clock will scan that frequency range as determined by the setting of the sector scan switch. The manual switches will determine the digital setting for the start of the sector scan except for the first position where the sweep is automatically the entire octave band. In the manual position of the sector scan the 1 PPS manual clock takes over the function of the variable scan clock and each digit may be varied by the manual switches to tune one digit per second.

The digital designation of frequency is by means of a Nixie tube readout.

The digital to analog converters supply the analog voltages for driving the operational amplifier which in turn couples the tuning voltage to the YIG or backward-wave oscillator or other voltage sensitive device.

Any further inquiries may be addressed to our Applications Engineering or to our representative in your area.

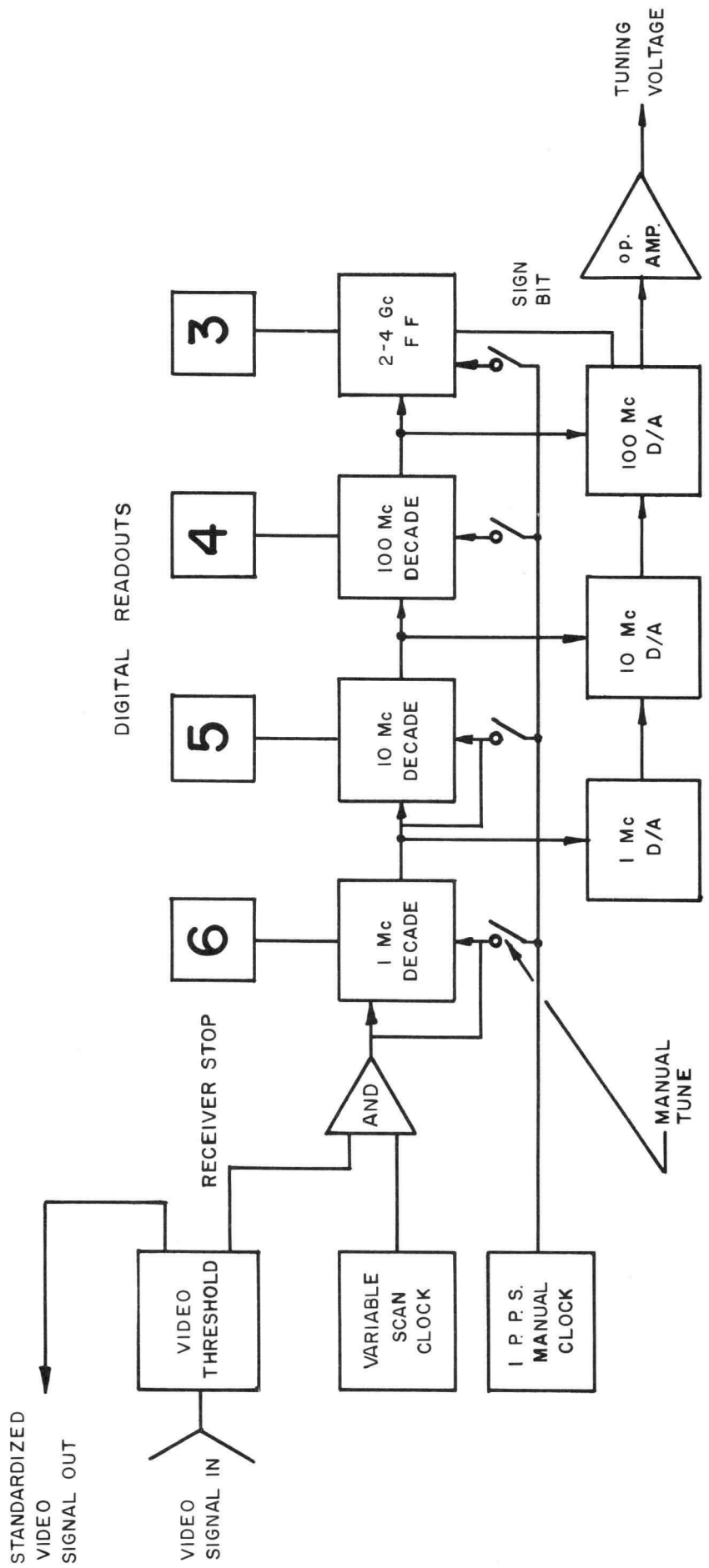

TENTATIVE SPECIFICATION

WJ-189 DIGITAL TUNING UNIT

ELECTRICAL

Input signal	Wideband video 1/2 to 5 v positive
Output signal	Standardized video at 4 v
Output tuning analog	2 mv/step staircase from -2 v to +2 v adjustable
Power input	20 w 115 v 60 cycle
Sweep rates	100 Gc/sec 50 Gc/sec 10 Gc/sec 1 Gc/sec
Scan sectors	2 Gc 1 Gc 100 Mc 10 Mc

WATKINS-JOHNSON COMPANY
Stanford Industrial Park
3333 Hillview Avenue
Palo Alto, California

Telephone: (415) 326-8830
Teletype: (910) 373-1253

1 June 1965



Vol. 7, No. 3, June 1965

WJ-191, 192, 193, 194

THE 1.0 TO 12.0 GC FREQUENCY RANGE PRESELECTOR-PREAMPLIFIER

- 1.0 to 12.0 GC COVERAGE
- 70 DB IMAGE REJECTION
- LOW-NOISE FIGURE
- OBJECTIVE OPERATION FROM -25°C to 71°C TEMPERATURE RANGE
- RFI TIGHT PACKAGE
- STABLE
- SMALL LIGHT WEIGHT
- LONG LIFE FIELD RELIABLE

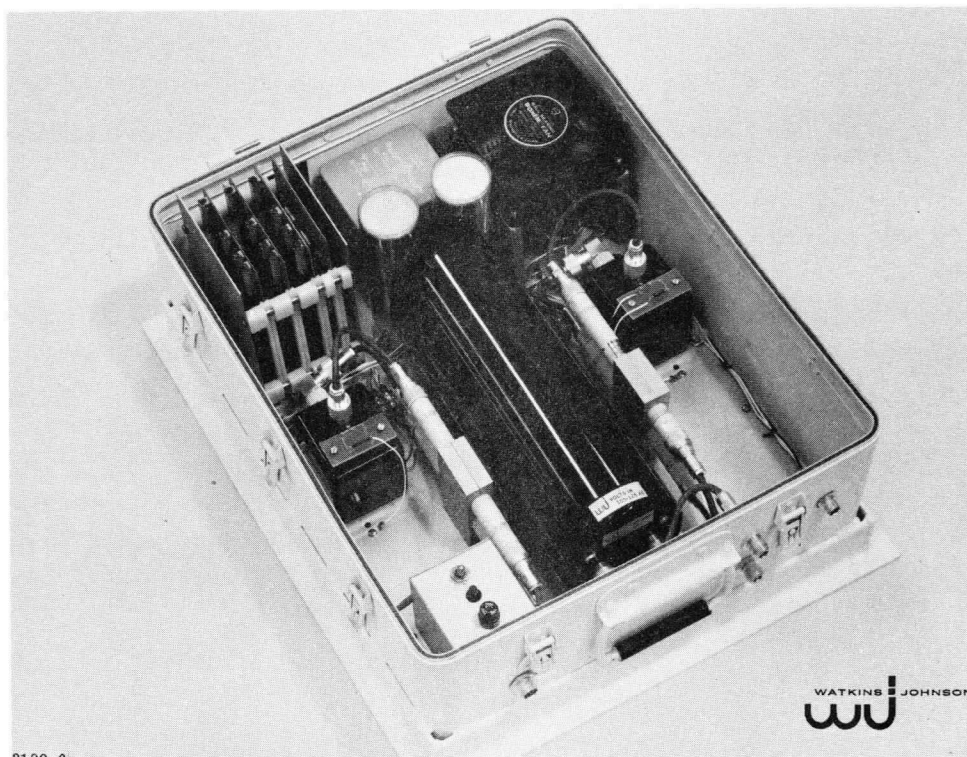

3199-6

The WJ-191 through WJ-194 equipments are compact units containing a Watkins-Johnson Company electrically tuned YIG filter in series with the input and output of a Watkins-Johnson Company ultra low-noise traveling-wave tube amplifier. All necessary power supplies and tuning circuitry for adjustment-free operation of the traveling-wave tube and filters are integrally packaged with the preselector-preamplifier. The units are

specifically designed for weatherproof operation and are packaged in RFI tight cases. The package configuration has been designed for high shielding effectiveness to allow its use in the proximity of high frequency transmitting devices and the internal magnetic components have been designed for a high level of shielding effectiveness in low frequency induction fields. The design is such that unaffected operation in the presence of high magnetic fields caused by power lines and high current servo devices can be accomplished. The maintenance of the equipment has been simplified in that a modular construction has been utilized.

In addition, the outside package has an automatic pressure differential valve to allow for any type of air transportation or operation at high altitude.

Applications

1. Avoids rf loss due to long runs of antenna cable. The preselector-preamplifier may be mounted directly at the antenna because of its weathertight construction.
2. Will extend the sensitivity of any standard receiver and allow greater range of measurements for spectrum and harmonic analysis, shielding effectiveness, antenna pattern analysis and propagation studies.
3. Converts a wide open receiver to an equipment with better than 50 db spurious rejection.
4. Allows normal operation of any receiver in the presence of strong signal because of added out of band signal rejection.
5. Allows accurate determination of frequency when used with appropriate control unit.
6. Measurement of low noise figure microwave devices.

As normally supplied, the preselector-preamplifiers are connected with one YIG-tuned filter in the input line and the second in the output as illustrated in the block diagram. The specifications for these units in the 1.0 to 12.0 Gc range are attached. This arrangement has the advantage of maximum reduction of spurious-modulation resulting from the presence of several strong signals in the band and eliminates the effects of unwanted saturating signals outside the passband.

As a customer-specified alternate, the preselector-preamplifiers can also be supplied with both YIG filters connected in series in the output line. For applications in which saturating input signals are not a problem, this arrangement has the advantage of lower noise figure, since the insertion loss of one YIG filter is removed from the input. The image rejection and passband specifications remain the same.

Tuning the passband may be accomplished in three ways: (1) Electrically swept over the full frequency band by means of a 0 to 10 volt tuning signal; (2) Manually tuned by means of a potentiometer connected to the tuning receptacle; and (3) Electrically swept over a sector of the full frequency band with desired center frequency set by an external manual tuning potentiometer.

The YIG drivers incorporated in the integrated preselector-preamplifiers are factory adjusted for exact frequency tracking. A tuning signal supplied to the high impedance input is sufficient for full band coverage for all units.

The preselector-preamplifiers are ruggedly designed to the requirements of MIL-E-5400. For specific applications, the equipments can be built to withstand the extended temperature range, (Class II) of -54°C to $+71^{\circ}\text{C}$.

Details of electrical and mechanical characteristics are given on the attached specification sheet.

Any further inquiries may be addressed to our Applications Engineering or to our representative in your area.

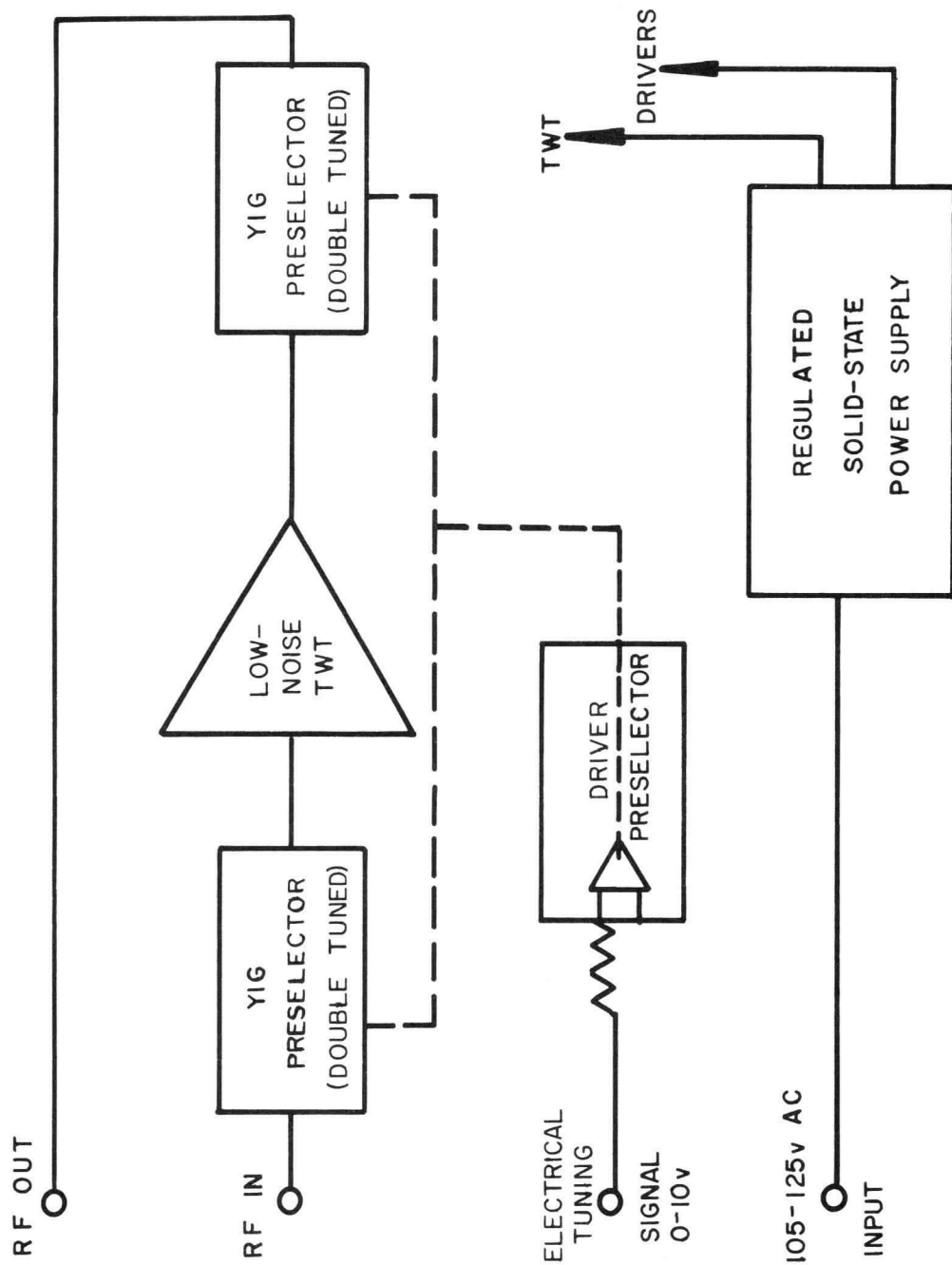



FIG. 1 - BLOCK DIAGRAM OF PRESELECTOR - PREAMPLIFIER

TENTATIVE SPECIFICATION

1.0 TO 12.0 GC FREQUENCY RANGE PRESELECTOR-PREAMPLIFIER

Frequency ¹ Gc	Model No.					Minimum Sat. Power Output dbin	Bandwidth Mc ±20%
		Noise Figure		Noise Figure*			
		Typical	Max. ²	Typical	Max. ²		
1.0-2.0	WJ-191	8.5	9.5	4.5	5.5	-25	12
2.0-4.0	WJ-192	7.0	9.0	4.5	6.0	-20	16
4.0-8.0	WJ-193	7.5	9.0	5.5	7.0	-5	18
8.0-12.0	WJ-194	9.0	11.0	7.0	9.0	-5	20

*YIG's after preamp, source VSWR less than 1.5

ELECTRICAL REQUIREMENTS

Primary voltage	105-125 v ac
Primary frequency	48-420 cps
Primary power	65-110 w
Tuning signal	0 to +10 v
Tuning signal input impedance	50 k ohms
Tuning signal sweep rate (full octave)	0 to 50 cps (L-, S-band) 0 to 30 cps (C-, X-band)
Tuning accuracy at nominal room temperature (linearity and resetability)	.25%
Tuning accuracy, -25°C to 71°C	±0.5%
Image rejection ³	70 db
Maximum spurious in frequency band	50 db
Gain	20 db min.
Pass-band ripple	3 db

ENVIRONMENTAL CHARACTERISTICS (all units)

Temperature	-25°C to +71°C
Vibration	
0.10 inch, double amplitude	5 to 30 cps
5 g, single amplitude	30 to 2000 cps
Altitude	70,000 feet

MECHANICAL CHARACTERISTICS (all units)⁴

Package length	22.0 inches, max.
Package cross-section	16.5 x 9 inches
Weight	60 pounds
RF connectors (50 ohm, nominal)	Type N, jack
Mounting	Barry mounts

NOTES:

1. These units are available for many frequency requirements between the ranges of 0.5 Gc to 18.0 Gc. Typical variations are 0.55 to 1.1 Gc, 1.0-2.6 Gc, 2.3 to 4.45, 4.3 to 7.35, and 7.05 to 10.75 Gc. Units capable of providing other electrical characteristics available upon request.
2. Wider bandwidth and lower noise figure can be obtained for specific applications.
3. Signal must be on the high side of L.O. to get 70 db, IF = 120 Mc.
4. Size and weight can be reduced based on electrical specification modifications.

WATKINS-JOHNSON COMPANY
Stanford Industrial Park
3333 Hillview Avenue
Palo Alto, California

Telephone: (415) 326-8830
Teletype: (910) 373-1253

1 June 1965



Vol. 7, No. 4, July 1965

WJ-195, 196, 197, 198

FAMILY OF VOLTAGE CONTROLLED MICROWAVE TUNERS

- TOTAL VOLTAGE CONTROL
- 80 DB IMAGE REJECTION
- 0.1% FREQUENCY LINEARITY
- 0.3% FREQUENCY ACCURACY
- 30 DB GAIN
- 80 DB SPURIOUS REJECTION
- NO MECHANICAL TRACKING
- LOWEST NOISE FIGURE IN ALL BANDS
- FOUR PASSIVE ELECTRICALLY TUNED PRESELECTOR STAGES
- 25 MC MINIMUM BANDWIDTH

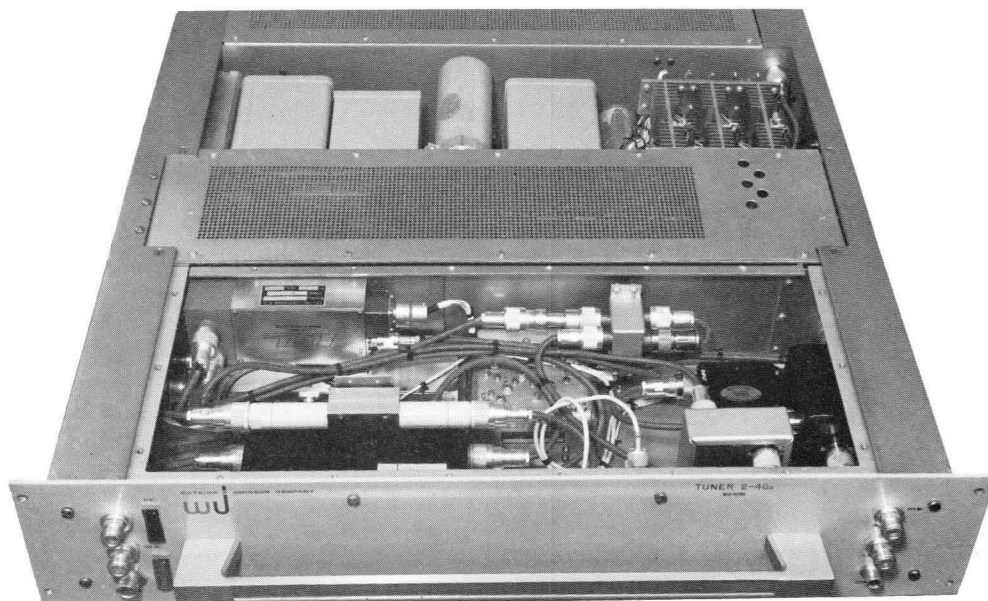

3199-22

The WJ-195 to WJ-198 is a family of voltage controlled microwave tuners designed to replace mechanically tuned converters with their inherent problems of backlash, mechanical instability and low reliability. The equipment is supplied in four bands operating from 1 Gc to 12 Gc with all power supplies completely self-contained.

A linear sawtooth voltage supplied to the high impedance input will simultaneously tune two double YIG preselectors and a backward-wave oscillator over a selected sector scan or over an octave bandwidth. Sweep frequencies as high as 50 cps may be obtained. A controlled dc voltage allows an operator to tune manually over the frequency band. Image¹ and spurious rejection greater than 80 db may be obtained in any mode of operation. The total voltage control tuner is packaged in an RFI tight enclosure to allow its use in the proximity of high power transmitting devices. The units may be obtained in ATR type enclosures or in weatherproof packages when specified in your order.

Applications

1. Converts wide open front end receiver to selective voltage tuned microwave receiver.
2. Converts IF, second detector and display to a sensitive, spurious free, microwave receiver.
3. Measurements of receiver local oscillator radiation.
4. Measurement of transmitter harmonics.
5. Measurements of rf leakage and shielding effectiveness.
6. General purpose surveillance receiver.

Equipment inputs are rf signal, + 10 volt high-impedance tuning signal, and 105-125 volt 48-420 cps single phase power. The equipment output is at an IF of 21.4 Mc.

Four models cover the following frequency bands:

<u>Model No.</u>	<u>Frequency Gc</u>
WJ-195	1.0-2.0
WJ-196	2.0-4.0
WJ-197	4.0-8.0
WJ-198	8.0-12.0

¹ Greater than 80 db image rejection is obtained for IF frequencies of 120 Mc or greater and for bandwidths up to 25 Mc.

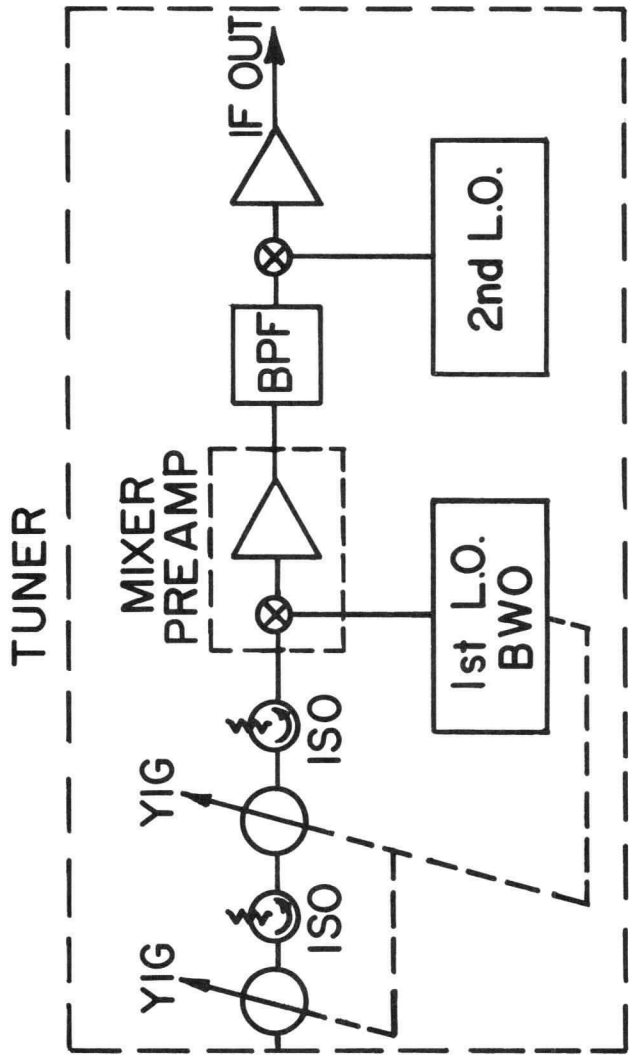

TOTAL VOLTAGE CONTROL TUNER
BLOCK DIAGRAM

These models are identical in size and therefore interchangeable.

A block diagram of the total voltage control tuner is shown in Figure 1. The rf input signal is coupled to the input, two-ball, YIG, then to the isolator and to the second, two-ball, YIG filter. This is equivalent to four cascaded tuned circuits and will yield a minimum 80 db¹ image rejection with an overall bandwidth of 25 Mc.

The signal is then coupled to the mixer, mixed with local oscillator injection, and converted to the IF frequency of 160 Mc. The backward-wave oscillator and the tuned frequency of the YIG preselectors are linear functions of the tuning voltage and are resettable to within 0.3 percent.

The IF frequency of 160 Mc is mixed with a second local oscillator operating at 138.6 Mc which is then converted to 21.4 Mc. This 21.4 Mc IF signal is amplified and is available at the IF output jack.

Any further inquiries may be addressed to our Applications Engineering or to our representative in your area.

TENTATIVE SPECIFICATION

WJ-195, 196, 197, AND 198

1.0 TO 12.0 GC FAMILY OF TOTAL VOLTAGE CONTROL TUNERS

PERFORMANCE

Input frequency band	
WJ-195	1-2 Gc
WJ-196	2-4 Gc
WJ-197	4-8 Gc
WJ-198	8-12 Gc
Overall bandwidth	25 Mc max.
Noise figure (single sideband)	
WJ-195	22 db max.
WJ-196	22 db max.
WJ-197	22 db max.
WJ-198	22 db max.
Image rejection ¹	80 db max.
Output intermediate frequency	21.4 Mc
Mixer input level	-15 dbm max.
Tuning accuracy	± 0.3 percent
Operating modes:	
(octave sweep)	Pan-full
(Δf about dial center frequency)	Pan-sector manual
Width of pan-sector mode	0 to ±250 Mc max.
Frequency readout	4 digit counter
Local oscillator short term stability (5 min.)	0.01% max.
Local oscillator incidental FM	30 kc peak-to-peak max.
Sweep rate	20 sweeps per sec. max.
Sweep recovery time	3 msec max.
Horizontal sweep output	±2.5 v max.
Sweep start trigger output	+20 v, 10 μ sec nom.
Retrace blanking output	+20 v, 3 msec nom.
Local oscillator frequency monitor output	-10 dbm min

ELECTRICAL REQUIREMENTS

Primary voltage	105-125 v
Primary frequency	48-420 cps
Primary power	200 w max.
Tuning signal	-10 to + 10 v
Tuning signal input impedance	50,000 ohms

ENVIRONMENTAL CHARACTERISTICS

Temperature	-25°C to +71°C
Vibration	
0.1 inch double amplitude	5 to 30 cps
5 g	30 to 2000 cps
Shock	15 g 11 ms
Altitude	Up to 70,000 ft max.

MECHANICAL CHARACTERISTICS²

Length	22 in. max.
Width	24 in. max.
Height	5 in. max.
Weight	100 lbs. max.
RF connectors (50 ohm nom.)	Type N Jack

¹ Greater than 80 db image rejection is obtained for IF frequencies of 120 Mc or greater and for bandwidths up to 25 Mc.

² Size and weight can be reduced based on electrical specification modification.

WATKINS-JOHNSON COMPANY
Stanford Industrial Park
3333 Hillview Avenue
Palo Alto, California

Telephone: (415) 326-8830

Teletype: (910) 373-1253

15 June 1965



Vol. 6, No. 7; July, 1964

WJ-165, 166, 167, 168

**PRESELECTOR-PREAMPLIFIER COVERING
THE 1.0 TO 12.0 GC FREQUENCY RANGE**

The WJ-165 through WJ-168 equipments are compact, weatherproof units containing a Watkins-Johnson Company electrically tuned YIG filter in series with the input and output of a Watkins-Johnson Company ultra-low-noise traveling-wave tube amplifier. All necessary power supplies and tuning circuitry for adjustment-free operation of the traveling-wave tube and filters are integrally packaged with the preselector preamplifier.

Equipment inputs are rf signal, ± 2 volt high-impedance tuning signal, and 105-125 volt, 48-400 cycle, single phase power.

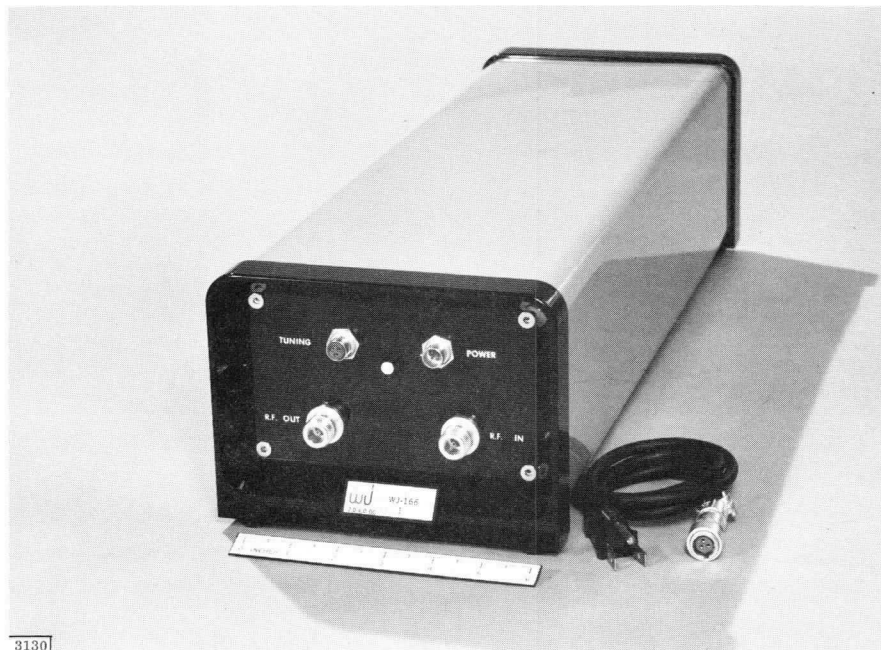

Equipment output is a tunable rf bandpass, nominally 30 Mc, with input terminal noise figure of less than 10 db.

Four identically-sized and interchangeable units cover the following frequency bands:

<u>Model No.</u>	<u>Frequency, Gc</u>
WJ-165	1.0 - 2.0
WJ-166	2.0 - 4.0
WJ-167	4.0 - 8.0
WJ-168	8.0 - 12.0

A block diagram of the preselector-preamplifier is shown in Fig. 1.

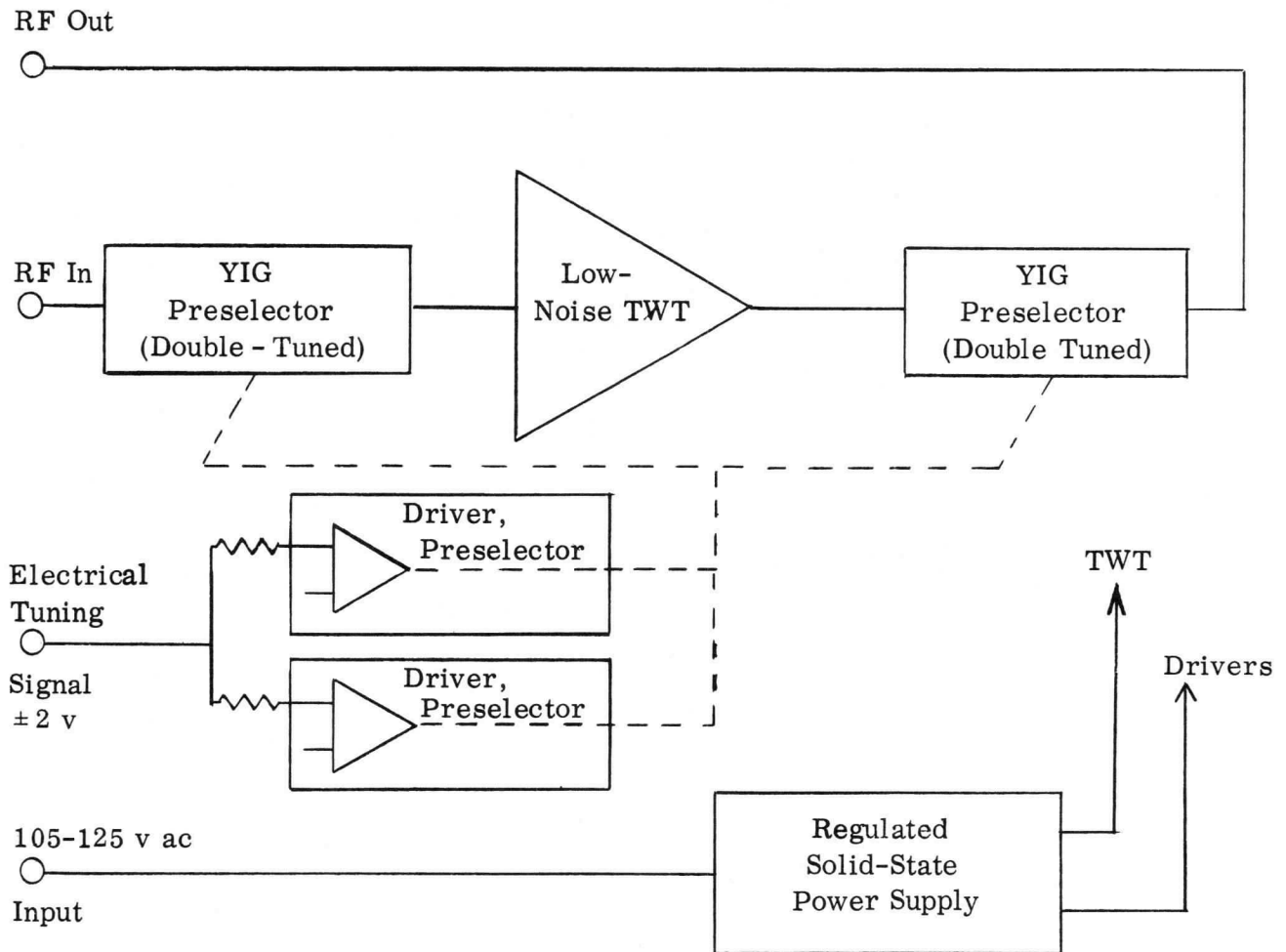

Fig. 1 - Block diagram of preselector-preamplifier

The outstanding performance features of the preselectors are low-noise figure, and when used in a superheterodyne receiver, a minimum image rejection of 80 db¹ with a maximum half-power bandwidth of 30 Mc. Typically this passband can be tuned over an octave bandwidth at sweep rates up to 50 cycles per second. The preselector frequency is a linear function of the tuning voltage and is resettable to within $\pm 0.1\%$.

The minimum gain of all units is 20 db, and the maximum noise figure ranges from 8 db in L-band to 10 db at X-band.

The greatest advantage of these units is realized when they are operated near the receiver antenna to minimize rf input line loss. They are therefore ruggedly designed for antenna tower mounting. The 5.5 x 7.5 x 22.0 inch sealed and shielded enclosure is mounted on the front and rear panel base by means of four quarter-inch fasteners. The unit may be mounted in any position. All of the electrical connections are provided at one end for a simplified cable layout.

As normally supplied, the preselector-preamplifiers are connected with one YIG-tuned filter in the input line, and the second in the output as illustrated in the block diagram. The specifications for these units in the 1.0 to 12.0 Gc range are attached. This arrangement has the advantage of maximum reduction of spurious-modulation resulting from the presence of several strong signals in the band, and eliminates the effects of unwanted saturating signals outside the passband.

As a customer-specified alternate, the preselector-preamplifiers can also be supplied with both YIG filters connected in series in the output line. For applications in which saturating input signals are not a problem, this arrangement has the advantage of lower noise figure, since the insertion loss of one YIG filter is removed from the input. The guaranteed maximum noise figure is reduced by 2 db for each band with this variation in construction. The image rejection and passband specifications remain the same.

Tuning the passband may be accomplished in three ways: (1) Electrically swept over the full frequency band by means of a ± 2 volt tuning signal; (2) manually tuned by means of a potentiometer connected to the tuning receptacle; and (3) electrically swept over a sector of the full frequency band with desired deviation center frequency set by an external manual tuning potentiometer. The connections for each method are illustrated in Fig. 2.

¹ Greater than 80 db image rejection is obtained for IF frequencies of 120 Mc or greater and for bandwidths up to 30 Mc. Consult Applications Engineering for recommended IF frequencies to obtain optimum image rejection.

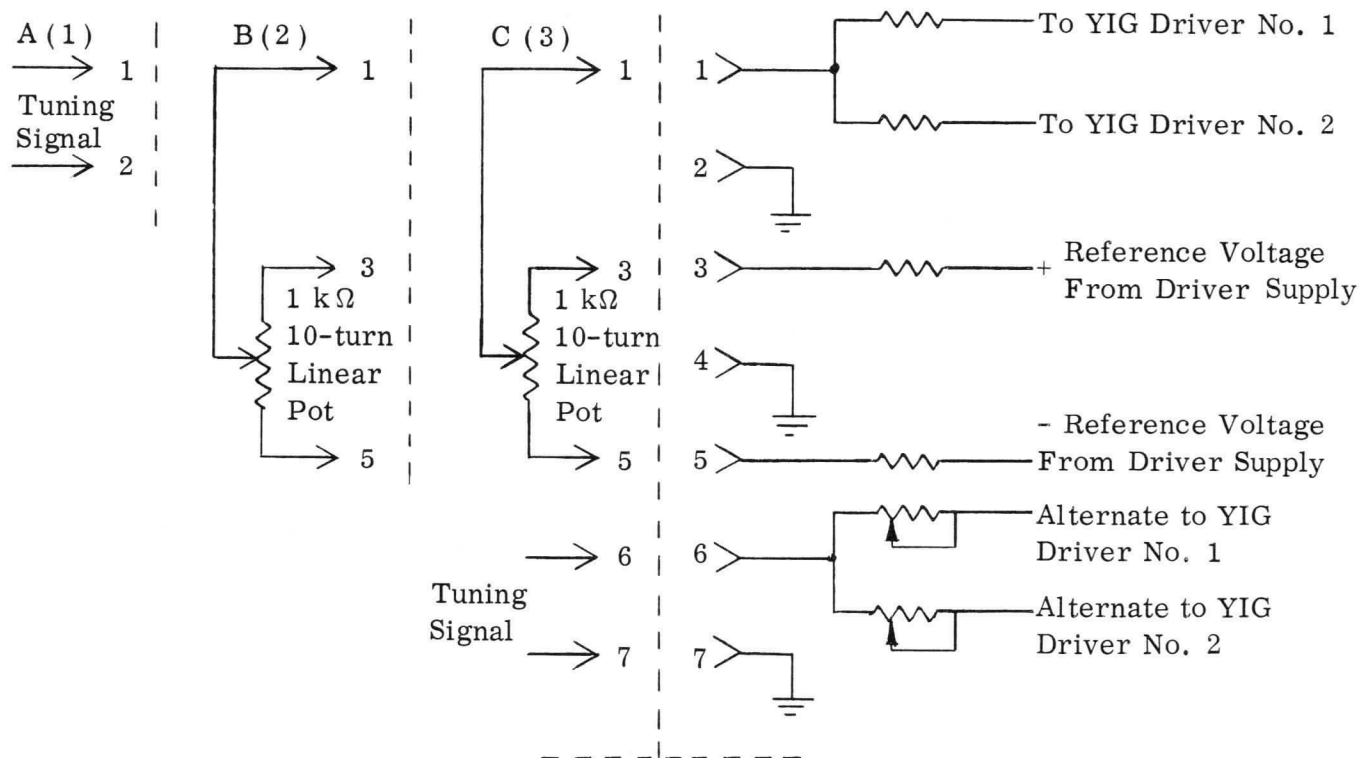

Deutsch Receptacle, DM 9601-75

Connection A (1)

External tuning signal supplied to pins 1 and 2, from a swept source for rapid full-band coverage.

Connection B (2)

External potentiometer derives manual tuning voltage from pins 3 and 5 for application to pin 1.

Connection C (3)

External tuning signal supplied to pins 6 and 7 and external potentiometer to pins 3 and 5. Internal summing network allows tuning signal to sweep any desired deviation about a frequency set by the manual control.

Fig. 2 - Connections for tuning the preselector-preamplifier.

The YIG drivers incorporated in the integrated preselector-preamplifiers are factory adjusted for exact frequency tracking. A ± 2 volt tuning signal supplied to the high impedance input is sufficient for full band coverage for all units. With zero signal, the passband is tuned to the band center. For example, the WJ-166 is tuned to 3000 ± 3 Mc with a zero tuning signal, and the exact voltages for tuning to the band edges, 2000 ± 2 Mc and 4000 ± 4 Mc are -2.0 and $+2.0$ volts respectively. Frequencies between these limits are linear with voltage within $\pm 0.1\%$ at nominal room ambient conditions. Over the extended temperature range of -25°C to $+71^{\circ}\text{C}$, the units are linear and resettable to within $\pm 0.5\%$.

The preselector-preamplifiers are ruggedly designed to withstand vibrational forces of 5 g up to 2000 cps and shocks in excess of 15 g, 11 millisecond duration. They may be operated up to 70,000 feet altitude. These environmental performance characteristics meet or exceed the respective requirements of MIL-E-5400. For specific applications, the equipments can be built to withstand the extended temperature range, (Class II) of -54°C to $+71^{\circ}\text{C}$.

Details of electrical and mechanical characteristics are given on the attached specification sheet.

Further inquiries may be addressed to our application engineering, or to our representative in your area.

TENTATIVE SPECIFICATION

1.0 TO 12.0 GC FAMILY OF YIG-TUNED PRESELECTOR PREAMPLIFIERS WITH INTEGRAL DRIVERS AND POWER SUPPLY

GUARANTEED PERFORMANCE

Frequency Gc	Model No.	Noise Fig. db (max.)	Gain db (min.)	Max. Bandwidth		Image ¹ Rejection db	Min. Sat. Power Out. dbm	Max. Spur. Passband Response
				(3 db) Mc	(40 db) Mc			
1.0-2.0	WJ-165	8	20	30	100	>80	-25	-50 db
2.0-4.0	WJ-166	8	20	30	100	>80	-20	-50
4.0-8.0	WJ-167	9	20	30	100	>80	-5	-50
8.0-12.0	WJ-168	10	20	30	100	>80	-5	-50

ELECTRICAL REQUIREMENTS

	<u>Range</u>
Primary Voltage	105-125 v ac
Primary Frequency	48-420 cps
Primary Power	30-40 watts
Tuning Signal ²	-2.0 to +2.0 v
Tuning Signal Input Impedance	1 megohm, min.
Tuning Signal Sweep Rate (full octave)	0 to 50 cps
Tuning Accuracy at Nominal Room Temperature (linearity and resettability)	±0.1%
Tuning Accuracy, -25°C to 71°C	±0.5%

¹ Greater than 80 db image rejection is obtained for IF frequencies of 120 Mc or greater and for bandwidths up to 30 Mc. Consult Applications Engineering for recommended IF frequencies to obtain optimum image rejection.

² For all models, the preselector is tuned to the exact mid-band point with zero volts applied to the tuning voltage input. The lower band edge is tuned with -2.0 volts in, and the upper limit with +2.0 volts.

TENTATIVE SPECIFICATION

1.0 TO 12.0 GC FAMILY OF YIG-TUNED PRESELECTOR PREAMPLIFIERS WITH INTEGRAL DRIVERS AND POWER SUPPLY

GUARANTEED PERFORMANCE

Frequency Gc	Model No.	Noise Fig. db (max.)	Gain db (min.)	Max. Bandwidth		Image ¹ Rejection db	Min. Sat. Power Out. dbm	Max. Spur. Passband Response
				(3 db) Mc	(40 db) Mc			
1.0-2.0	WJ-165	8	20	30	100	>80	-25	-50 db
2.0-4.0	WJ-166	8	20	30	100	>80	-20	-50
4.0-8.0	WJ-167	9	20	30	100	>80	-5	-50
8.0-12.0	WJ-168	10	20	30	100	>80	-5	-50

ELECTRICAL REQUIREMENTS

	<u>Range</u>
Primary Voltage	105-125 v ac
Primary Frequency	48-420 cps
Primary Power	30-40 watts
Tuning Signal ²	-2.0 to +2.0 v
Tuning Signal Input Impedance	1 megohm, min.
Tuning Signal Sweep Rate (full octave)	0 to 50 cps
Tuning Accuracy at Nominal Room Temperature (linearity and resettability)	±0.1%
Tuning Accuracy, -25°C to 71°C	±0.5%

¹ Greater than 80 db image rejection is obtained for IF frequencies of 120 Mc or greater and for bandwidths up to 30 Mc. Consult Applications Engineering for recommended IF frequencies to obtain optimum image rejection.

² For all models, the preselector is tuned to the exact mid-band point with zero volts applied to the tuning voltage input. The lower band edge is tuned with -2.0 volts in, and the upper limit with +2.0 volts.

ENVIRONMENTAL CHARACTERISTICS

Temperature	-25°C to +71°C
Vibration	
0.10 inch, double amplitude	5 to 30 cps
5 g, single amplitude	30 to 2000 cps
Shock	15 g, 11 ms
Altitude	70,000 feet

MECHANICAL CHARACTERISTICS

Package length	22.0 inches, max.
Package cross-section	5.5 x 7.5 inches, max.
Weight	40 pounds, max.
Primary power connector, Deutsch receptacle	DM 9601-3P
RF connectors (50 ohm, nominal)	Type N, jack
Tuning control connector, Deutsch receptacle	DM 9601-7S

WATKINS-JOHNSON COMPANY
Stanford Industrial Park
3333 Hillview Avenue
Palo Alto, California

1 July 1964

Telephone: (415) 326-8830
Teletype: (910) 373-1253



Vol. 3, No. 10; September, 1961*

THE WJ-501

Electronically-Tuned Microwave Filters

In many microwave system applications it is desirable to have a relatively narrow instantaneous rf bandwidth which can be tuned quickly and easily over a wide range of frequencies. Prior to May, 1961, when the Watkins-Johnson Company first announced the development of the WJ-501, there had been no satisfactory method of accomplishing this with a passive device. The WJ-501 is the first microwave preselector filter which can be tuned electronically over a wide range of frequencies with relatively low insertion loss. This filter uses the principle of low-loss gyromagnetic resonance in a single-crystal yttrium iron garnet (YIG) to achieve a high-Q resonant structure whose resonant frequency can be changed by means of a DC magnetic field.

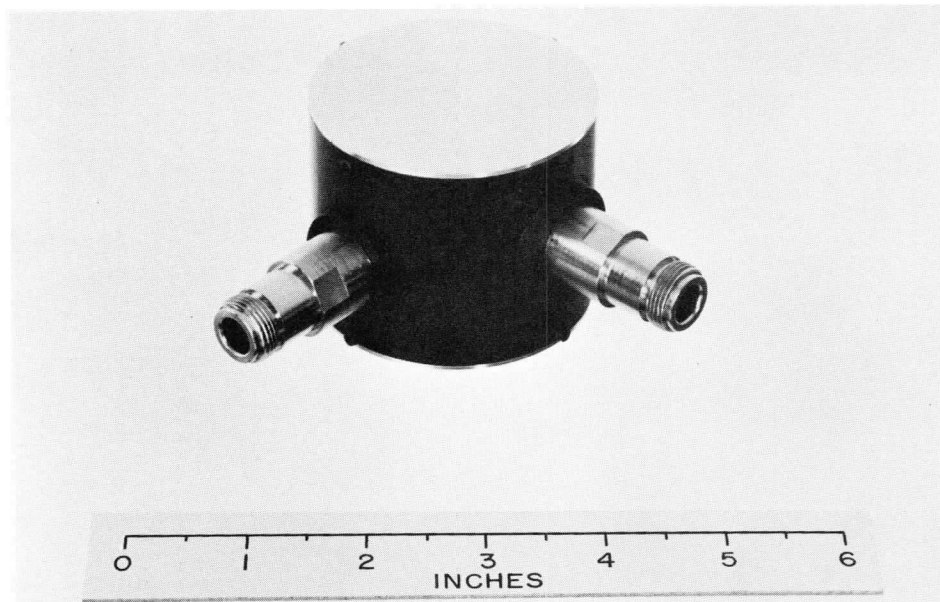

2287

The WJ-501 is a single-tuned filter designed to operate over an entire octave range from 2000 to 4000 Mc. A combination of permanent-magnet and solenoid tuning is used to minimize the size, weight, and power consumption of the filter. The complete filter weighs less than 2 pounds, including the magnetic structure, and consumes only 3 watts of low-voltage DC power. Typical curves of insertion loss and bandwidth as a function of frequency are shown in Figs. 1 and 2.

* This Technical Bulletin presents up-to-date information on the WJ-501 first described in Vol. 2, No. 3; May, 1960.

An additional feature of the WJ-501 is its low-power limiting properties. Below about 3.5 kMc the filter saturates at less than a milliwatt of input power. As the power is increased above this limiting value, very little increase in transmitted power is observed. The balance of the power is largely reflected, protecting the filter and succeeding stages of the system from damage or saturation. Fig. 3 shows typical limiting power levels for the WJ-501 Electronically-Tuned Microwave Filter.

The WJ-501 was not specifically designed for very high tuning rates and hence the inductance of the tuning coil is higher than necessary. Inquiries are invited regarding the design of filters capable of higher tuning rates, as well as for filters in other frequency ranges or with different bandwidths.

If greater selectivity is desired, double-tuned units can also be supplied in similar configurations.

Any further inquiries may be addressed to our Applications Engineering or to our representative in your area.

TENTATIVE SPECIFICATION

WJ-501, 2-4 Gc Electronically-Tuned Microwave Filter

ELECTRICAL

Frequency range	2000-4000 Mc
Typical insertion loss at resonance	1.7 db-0.7 db
Typical bandwidth (3 db), 50 ohm load	15 Mc-25 Mc
VSWR	< 2.0
Off-resonance isolation in band	> 40 db
DC current for \pm 1000 Mc tuning around 3 Gc	400 ma (at 7 volts)
Tuning coil inductance	8 mh
Tuning sensitivity	2.5 Mc/ma

MECHANICAL

Diameter (excluding connectors)	2 3/4 inches
Height	2 1/8 inches
Weight	1.8 pounds
RF connectors	Type N

WATKINS-JOHNSON COMPANY
Stanford Industrial Park
3333 Hillview Avenue
Palo Alto, California
Telephone: Davenport 6-8830

5/1/62
(Revision of Sept., 1961
revision)

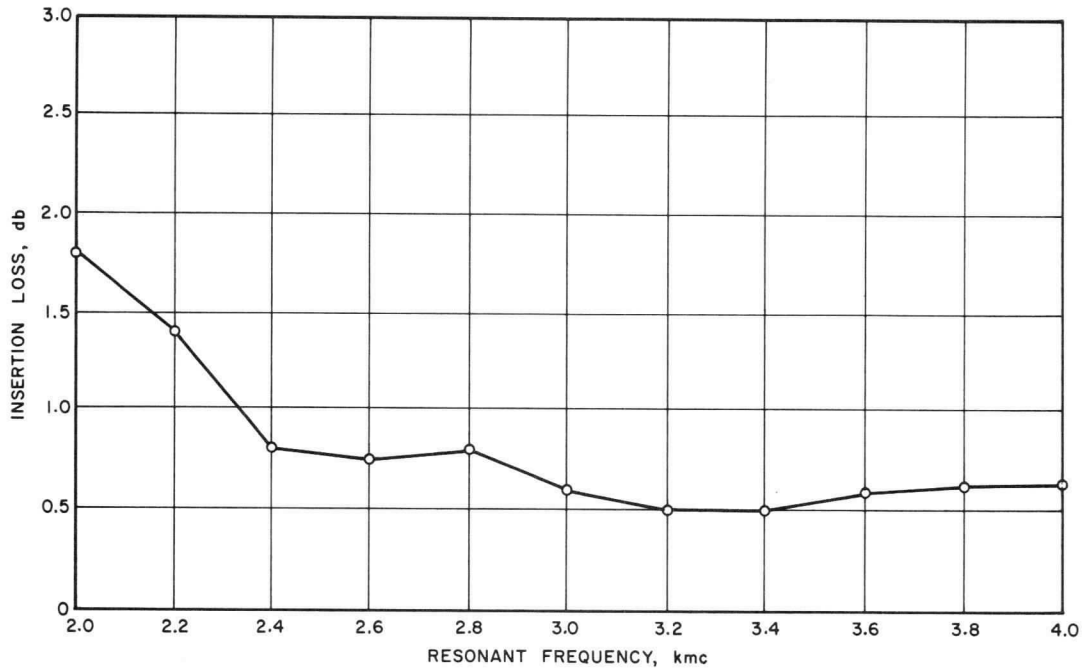

FIG. 1 - THE WJ-50I INSERTION LOSS DECREASES AS THE RESONANT FREQUENCY IS RAISED AS INDICATED ABOVE.

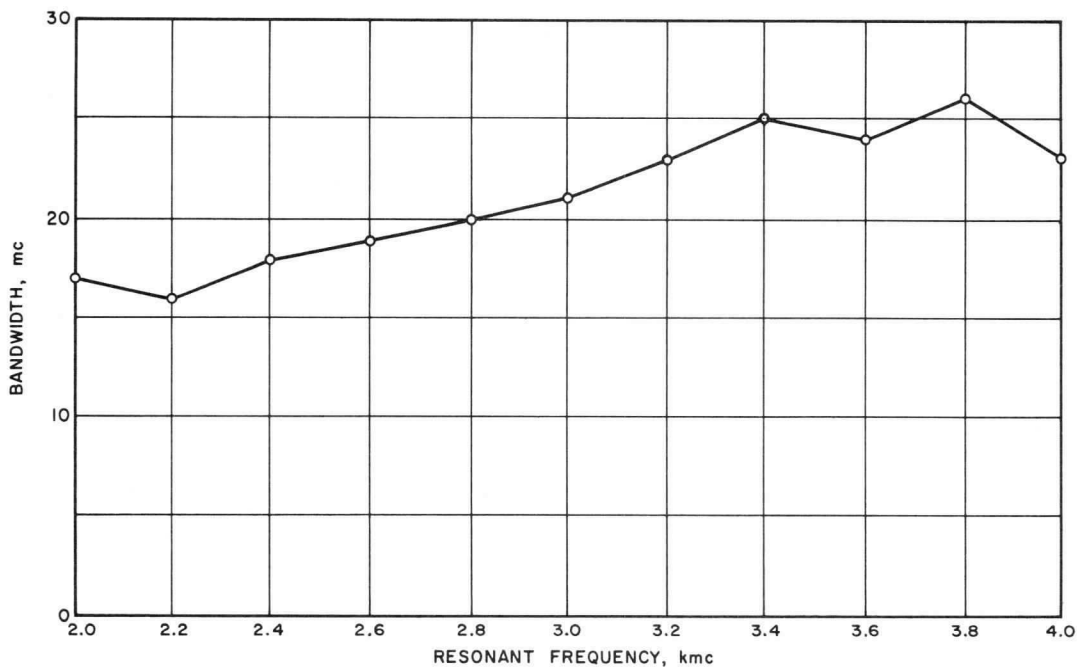

FIG. 2 - THE WJ-50I 3db BANDWIDTH INCREASES ONLY SLIGHTLY WITH FREQUENCY. THE DATA IN FIGS. 1 AND 2 WERE TAKEN IN 50 OHM SYSTEMS.

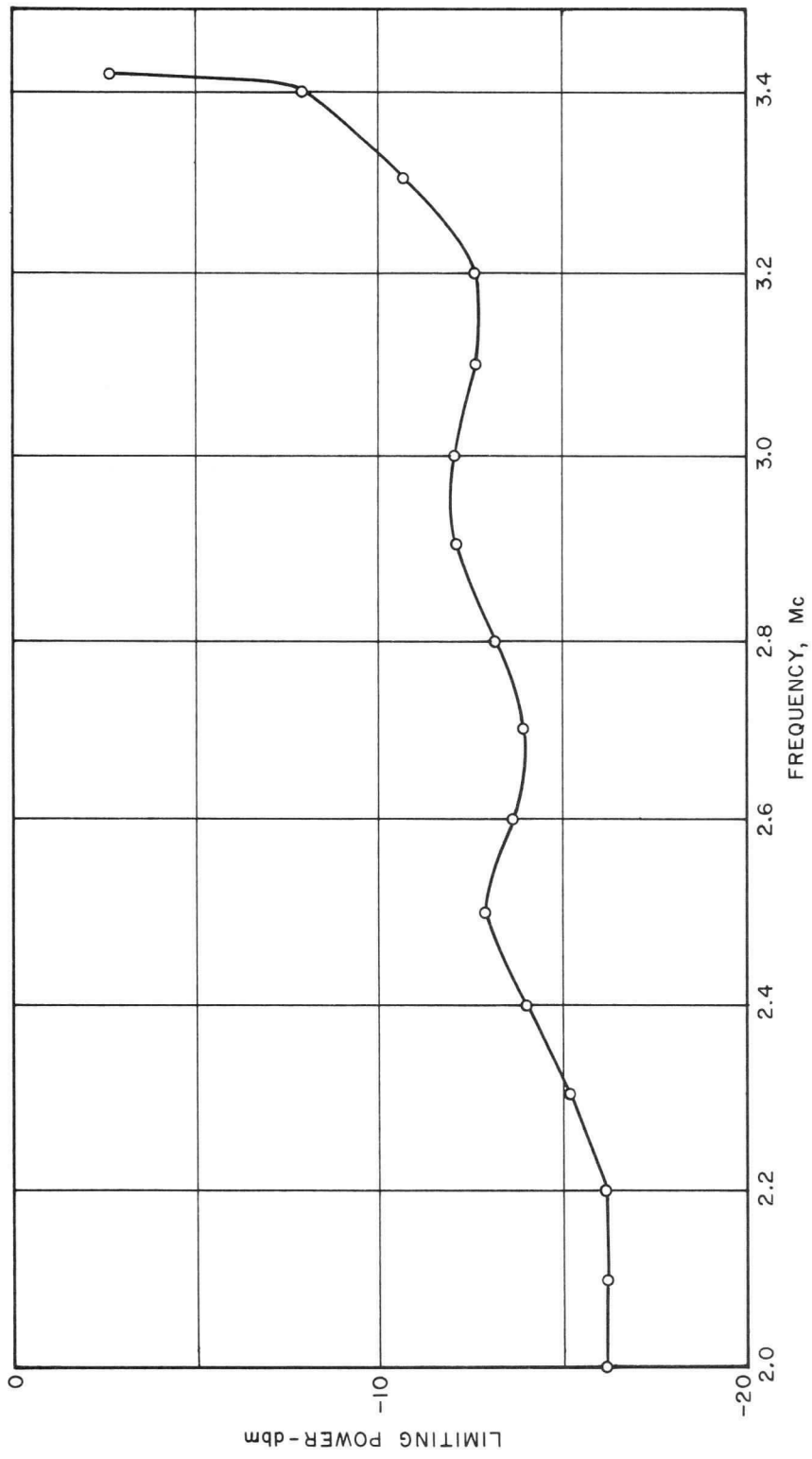

FIG. 3 - TYPICAL LIMITING POWER LEVEL OF THE WJ-501 ELECTRONICALLY-TUNED MICROWAVE FILTER.



Vol. 4, No. 5; June 1962

THE WJ-505

Electronically-Tuned Microwave Filters with Rapid-Switching Capabilities

Ferrite components are considered as basically slow switching devices. This is in large measure due to the presence of substantial stored energy in the required magnetic field; to change this stored energy rapidly, large amounts of switching power are required. It therefore follows that if a fast switching device is required, the magnetic stored energy must be minimized. In a YIG filter, the magnetic field requirements are specified by the operating frequency and tuning range. Therefore little can be done to minimize tuning power in YIG filters from this standpoint other than in using a permanent magnet to bias the filter to the nominal center operating frequency. However, since the YIG resonator is typically very small, it is possible greatly to minimize the stored magnetic energy by reducing the volume over which the required magnetic field exists.

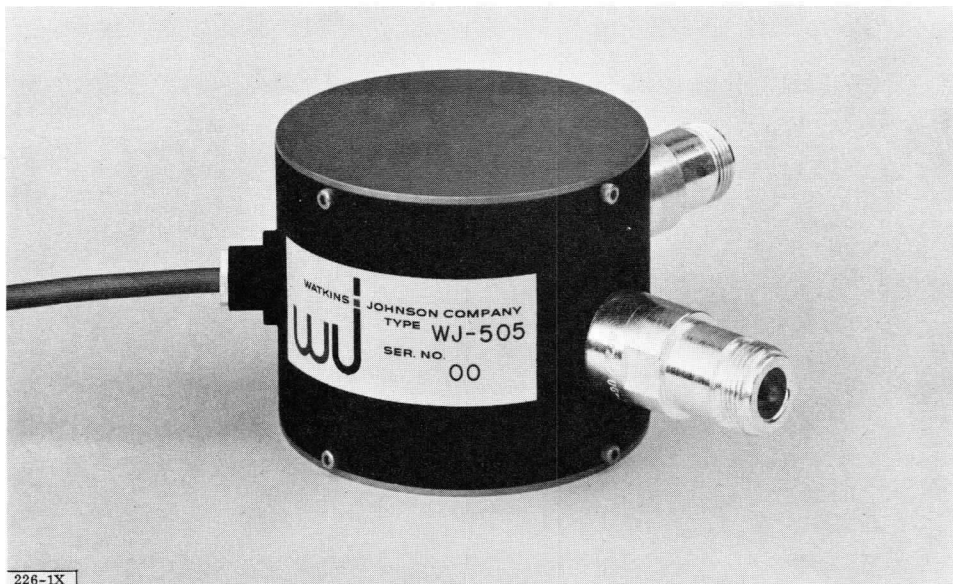

But even if the stored magnetic energy is greatly reduced, fast switching is not necessarily obtained. A further consideration is the shielding effects introduced by metallic surfaces in the vicinity of the tuning coil and YIG resonator. The presence of such conducting material results in attenuation of the high-frequency components of the switching magnetic field.

To obtain a fast switching YIG filter, it is therefore necessary both to minimize the stored magnetic energy in the switching circuit and the shielding effects due to metallic surfaces.

Employing such concepts, Watkins-Johnson Company has developed a YIG filter structure capable of fast switching at reasonable drive power levels. This circuit is useful in single-tuned bandpass configurations at operating frequencies up to approximately 7000 Mc.

Typical characteristics of the most recently designed tuning circuits are an inductance of 10^{-5} h with a tuning constant of 1.5 ma/Mc. Thus to tune such a filter 500 Mc in one microsecond, the calculated peak switching power is about 6 watts. This is independent of the particular microwave operating frequency of the filter. An example of such a unit is the WJ-505 (See Tentative Specification attached).

The ultimate limit to the tuning speed of these devices appears to be the "ringing" time of the filter, (which is inversely proportional to its instantaneous bandwidth), together with the dissipation capabilities of the tuning coil. To date, the shortest switching time which has been measured at Watkins-Johnson Company is less than 100 nanoseconds for a change of 100 Mc. Further improvement should be possible with additional refinement of the filter structure and driver.

Any further inquiries may be addressed to our Applications Engineering or to our representative in your area.

TENTATIVE SPECIFICATION

WJ-505, C-Band High-Speed Electronically-Tunable Filter

<u>PERFORMANCE</u>	<u>Typical</u>	<u>Guaranteed</u>
Maximum frequency	5.9 Gc	5.9 Gc
Minimum frequency	5.4 Gc	5.4 Gc
Insertion loss	1.0-2.0 db	3.0 db
<u>ELECTRICAL PROPERTIES</u>	<u>Typical</u>	<u>Range</u>
Center frequency with zero applied current	5.65 Gc	5.60-5.70 Gc
Filter bandwidth, 3 db	25 Mc	10-30 Mc
DC tuning constant	2 ma/Mc	1-4 ma/Mc
Switching time ¹	1 μ sec	0.1-10.0 μ sec
DC coil inductance	10 μ h	5-20 μ h
DC coil resistance	1.8 ohms	1-4 ohms
<u>MECHANICAL PROPERTIES</u>		
Diameter (excluding connectors)	2 3/4 inches	
Height	2 1/8 inches	
Weight	1.8 pounds	
RF connectors	Type N	
<u>MAXIMUM RATINGS²</u>	<u>Maximum</u>	
Peak tuning coil voltage	100 v	
Tuning coil dissipation	2 w	

- Notes: 1. For definition of "switching time" see Fig. 1.
2. Not to be exceeded or the unit may be permanently damaged.

WATKINS-JOHNSON COMPANY
Stanford Industrial Park
3333 Hillview Avenue
Palo Alto, California
Telephone: Davenport 6-8830

21 June 1962

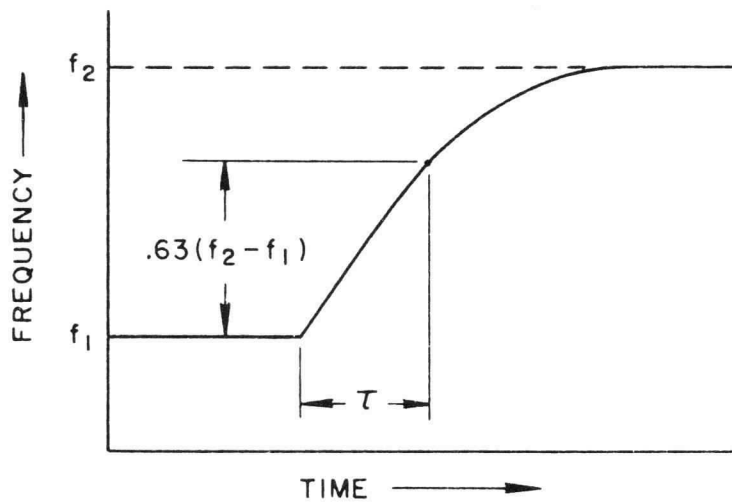
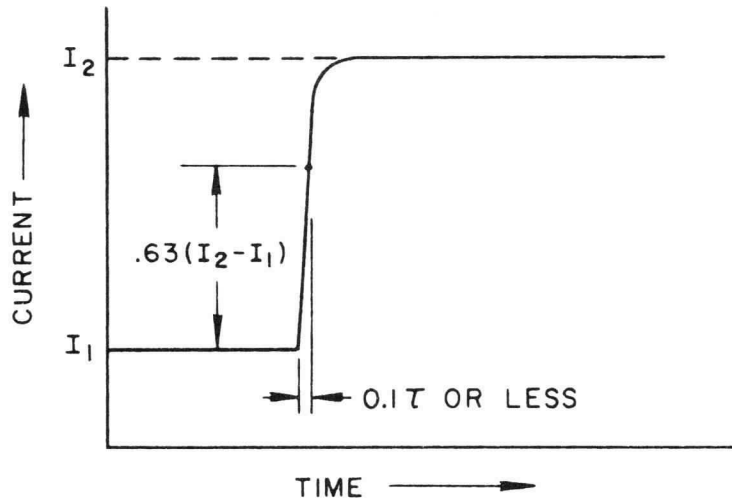

FIG.1- THE SWITCHING TIME τ IS DEFINED IN TERMS OF FILTER RESPONSE TO A STEP CHANGE OF CURRENT. IF THE CURRENT RISE TIME IS SHORT COMPARED TO THE FILTER SWITCHING TIME, THEN THE TIME REQUIRED FOR THE FILTER TO ACHIEVE 63 PERCENT OF ITS FREQUENCY CHANGE IN RESPONSE TO THE CURRENT INPUT STEP IS EQUAL TO τ .



Vol. 4, No. 8; October, 1962

THE WJ-506

Electronically-Tuned Bandpass Filter

The WJ-506 is an electronically-tuned bandpass filter designed to cover the entire frequency range of WR-90 waveguide (8.2 to 12.4 Gc). It possesses the selectivity of a double-tuned resonant circuit with good suppression of spurious resonances. The insertion loss is less than 2 db over the full tuning range with a 3 db bandwidth less than 30 Mc.

One of the unique features of the WJ-506 is its nonreciprocity. A passband transmission characteristic of low insertion loss is present only in one direction through the filter; energy traveling in the opposite direction is greatly attenuated. This configuration also allows the utilization of internal resistive terminations, which results in matched input and output impedances both on and off resonance, without increase in filter insertion loss. The WJ-506 is thus electrically equivalent to a bandpass filter with an isolator before it, and a second isolator following it.

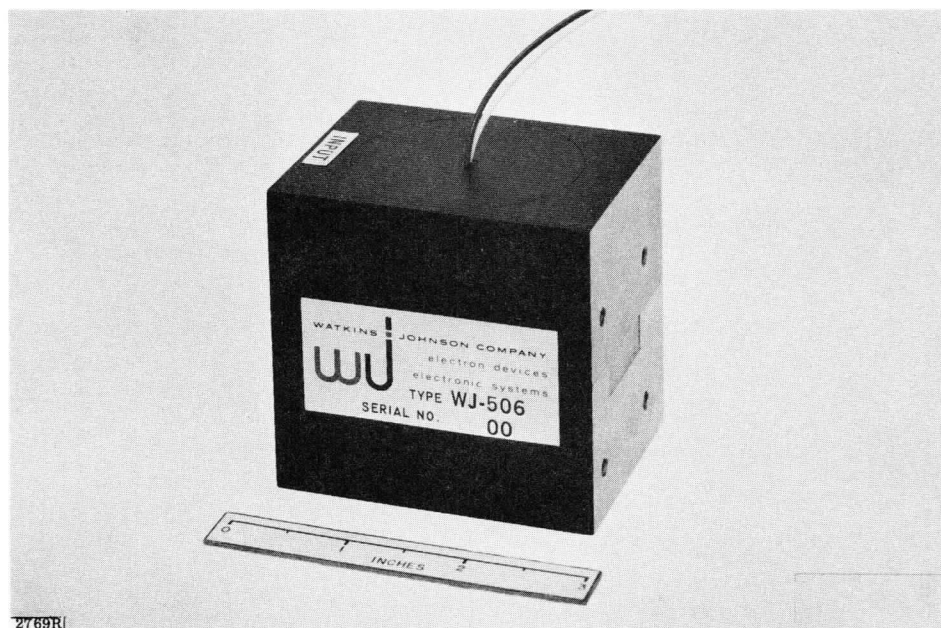

The WJ-506 incorporates a permanent magnet which simultaneously biases two yttrium iron garnet (YIG) spheres to resonance to obtain a synchronously-tuned bandpass response centered at approximately 10.2 Gc. The filter is then tuned to other frequencies by supplying the proper current to a set of tuning coils incorporated within the unit. Proper tracking of the two garnet resonators is maintained over the entire tuning range. As an added convenience, a second set of tuning coils is incorporated which enables the user to

electronically de-tune the two resonators without changing the center frequency of the pass-band. Thus some degree of electronic passband control is possible.

The WJ-506 measures only 2.1 inches wide by 2.6 inches high and is less than 3 inches long. The waveguide input and output are parallel, which makes its incorporation into a waveguide system extremely simple. The construction is rugged, resulting in a unit which can operate over a wide range of environmental conditions.

DEVELOPMENTAL SPECIFICATION

WJ-506, 8.2-12.4 Gc Non-Reciprocal Electronically Tunable Filter

This Developmental Specification is subject to change without notice. It should not be used without the advice of Watkins-Johnson Applications Engineering regarding the current technical status of the item described.

ELECTRICAL PERFORMANCE

Frequency range	8.2-12.4 Gc
Insertion loss at resonance	< 2 db
Bandwidth (3 db)	30 Mc
Skirt selectivity	12 db/octave
VSWR (on and off-resonance)	< 2.0
Off-resonance isolation in band	> 50 db
Spurious level	-30 db or better
Directivity	> 25 db
DC power for ± 2 Gc tuning	3 watts

MECHANICAL

Size	2.1" x 2.6" x 2.75"
Weight	1.6 lb
RF connection	RG-52/U flange
DC connection	Flying leads

WATKINS-JOHNSON COMPANY
3333 Hillview Avenue
Palo Alto, California

Davenport 6-8830

1 October 1962



Vol. 4, No. 2; March 1962

LOW-POWER FERRITE LIMITERS

There are many occasions where the performance of an electronic system can be improved by the utilization of passive low-power (milliwatt range) microwave limiters. Protection from burn-out in a sensitive receiver is one application which is well known. A limiter can also be used to level the input power to a device which works well only over a small dynamic range. A more recent application which has become practical is receiver protection against blocking by a strong interfering signal.

In these and other applications, passive ferrite limiters which operate at low power levels possess several unique and highly useful characteristics. The important characteristics of low-power limiters are:

- 1) Low insertion loss. When operating in the linear range, a low-power ferrite limiter can have an insertion loss of less than one db since the intrinsic unloaded Q of the ferrite is usually quite high.
- 2) Magnetic tuning. Such limiters can have narrow instantaneous bandwidth (on the order of one percent) and be magnetically tunable over wide ranges in frequency, or have wider bandwidths (about ten percent) in fixed-tuned configurations.
- 3) Low-power limiting threshold. Between approximately 2000 Mc and 3500 Mc the limiting threshold is typically on the order of 0.1 mw or less. Over the range 4000 Mc to about 7500 Mc the limiting threshold is on the order of one milliwatt.
- 4) Large dynamic range. Greater than 20 db of limiting range can be achieved.
- 5) Minimum phase distortion at limiting. The limiting mechanism produces very little change in phase in the limiting region. Measurements at spot frequencies have indicated phase changes of less than $\pm 10^\circ$ over a 20 db limiting range.
- 6) Frequency-selective limiting characteristics. The usual amplitude limiter, such as a diode clipper, has the property that suppression of a small signal will occur when the limiter is limiting on a large signal. In practice this means that a single large signal anywhere within the pass band of a receiver will "block" the receiver over the entire band. This can be particularly troublesome with broadband receivers such as those employing traveling-wave tubes. One solution to this problem is to put a narrow-band tunable pre-selector filter ahead of the receiver, but then, of course, the receiver cannot simultaneously receive signals at several widely-

separated frequencies. Another solution is to use a limiter which does not suppress a small signal while limiting a large signal. Such a limiter can be termed a frequency-selective limiter since individual frequency components are selectively limited. A low-power ferrite limiter is just this type of device.

PRINCIPLES OF OPERATION

The low-power ferrite limiters under discussion use the principle of coupling to a single-crystal sample of either yttrium iron garnet or lithium ferrite which is biased by a magnetic field to resonance. Below the limiting threshold, these devices act as linear passive band-pass filters, either reciprocal or nonreciprocal. At large signal levels, these ferrites exhibit a rather complicated behavior. Perhaps the most definitive treatment in this area is that due to Suhl¹. His analysis treats three major saturation effects which can occur; these are saturation of the main resonance, the appearance of a subsidiary absorption, and a condition involving the coincidence of the main and subsidiary resonance. All of these large signal effects are caused by coupling of energy from the uniform precession mode to so-called spin waves, but there is a large variation between them in the power levels at which the nonlinearity becomes evident. Suhl's analysis shows that the lowest threshold power occurs for the mode in which there is coincidence of the main and subsidiary responses. It is this mode of limiting which is utilized in the low-power limiters under discussion.

Frequency Range

The frequency range over which this type of limiting will occur is determined primarily by the saturation magnetization, and also by the geometry of the sample. For a particular material, a frequency range of somewhat less than an octave can be achieved. YIG, for example, shows coincidence limiting from about 1800 Mc to 3500 Mc, while lithium ferrite shows such limiting from about 4000 Mc to 7500 Mc. Significant extension of this mode of limiting to other frequency ranges must await further development of suitable materials.

Minimum Phase Distortion

Two important properties of low-power ferrite limiters are minimum phase distortion while limiting, and frequency-selective limiting. Both of these properties can be explained by considering the ferrite limiter as a passive parametric limiter of the type described by Siegman². Siegman shows that such a limiter need not have any phase distortion while limiting; this property has indeed been observed in ferrite limiters with typical values of phase distortion being less than $\pm 10^\circ$ over a 20 db limiting range.

Frequency-Selective Limiting

The frequency-selective limiting feature arises from the fact that a ferrite resonator will behave as an array of parametric limiters operating in parallel in such a fashion as to produce independent limiting of signals which are separated in frequency by an amount comparable to the bandwidth of any single limiter³. Curves which illustrate typical results in S-band are shown in Fig. 1 and 2. In this experiment, two signals were used, one a cw signal at a power level above limiting, and a square-wave modulated signal below limiting. The amplitude of the modulated signal was then observed as the frequency of the large signal was varied. The bandwidth of the filter was about 9 Mc and the insertion loss was about 1.5 db.

Fig. 1 shows the frequency separation required between the two signals in the experiment in order to suppress the small signal by 3 db. As the large signal power is increased, greater separation is required to avoid suppression of the small signal. Figure 2 shows how a small signal at 2700 Mc is suppressed as the frequency and power of the large signal is varied. Quite high suppression occurs when the two signals coincide.

Similar results have been obtained with filters of wider bandwidths, both in S-band and C-band. Examples of such devices are the WJ-507 series, presently being developed at Watkins-Johnson Company.

The performance of the WJ-507-2 is illustrated by the three oscillograph displays of Fig. 3. In the top display is shown the frequency response of the WJ-507-2 as obtained with a sweeping oscillator, together with a reference display of the output of the sweeping oscillator. The small-signal characteristics of the unit displayed are 200 Mc bandwidth and 1 db insertion loss at 5.85 Gc. In the second and third displays a cw signal above limiting threshold has been added at band center. The power level of this signal in the center display is 10 db above limiting threshold, while that of the bottom display is 25 db above threshold. These drawings vividly show how the small signal is suppressed only in the immediate vicinity of the large signal, even at extremely high over-load conditions.

REFERENCES

1. H. Suhl, "The Nonlinear Behavior of Ferrites at High Microwave Signal Levels", Proc. IRE, vol. 44, pp. 1270-1284; October, 1959.
2. A. E. Siegman, "Phase-Distortionless Limiting by a Parametric Method", Proc. IRE, vol. 47, pp. 447-448; March, 1959.
3. K. L. Kotzebue, "Frequency-Selective Limiting in YIG Filters", Jour. Appl. Phys.; to be published.

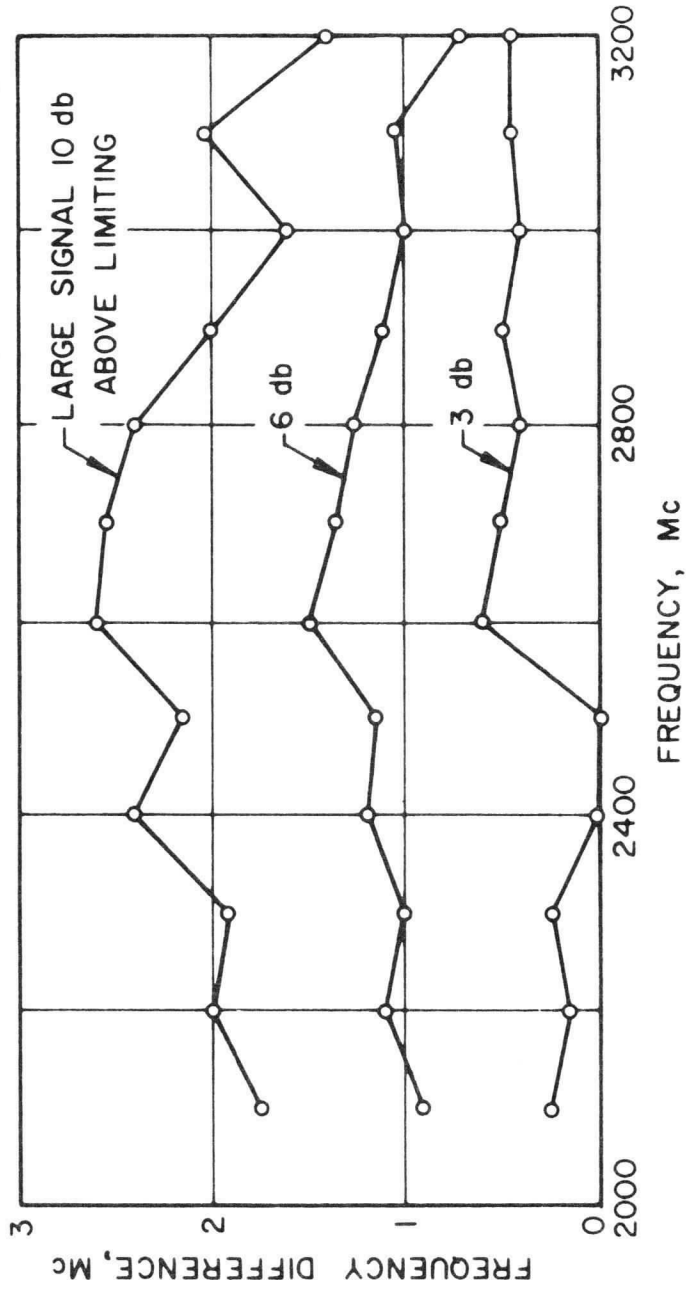

FIG. 1 - FREQUENCY DIFFERENCE REQUIRED BETWEEN A LARGE AND SMALL SIGNAL TO PRODUCE 3db SUPPRESSION OF THE SIGNAL BELOW LIMITING THRESHOLD.

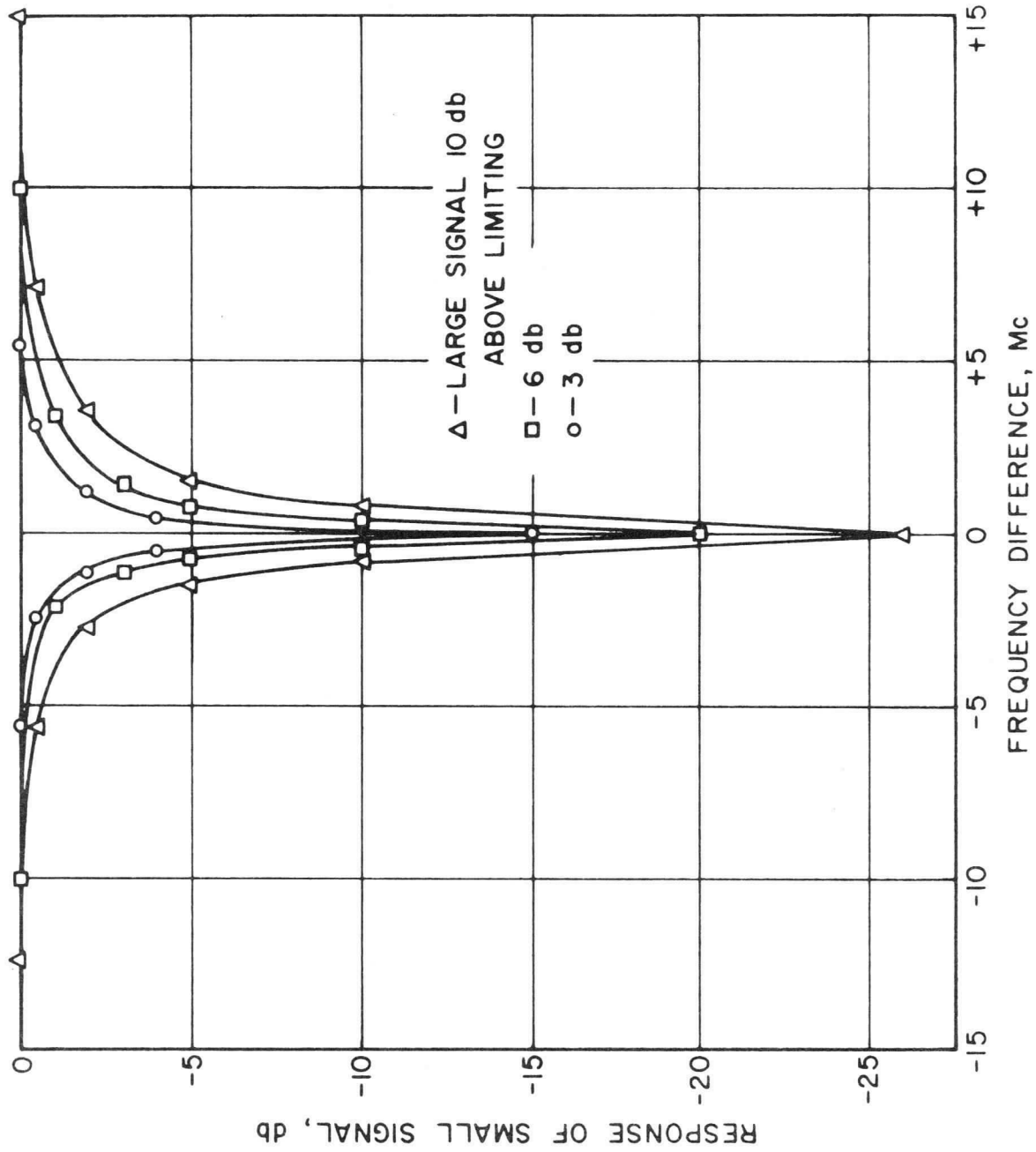

FIG. 2 - SMALL - SIGNAL SUPPRESSION AT 2700 Mc AS A FUNCTION OF FREQUENCY DIFFERENCE AND LARGE SIGNAL POWER LEVEL.

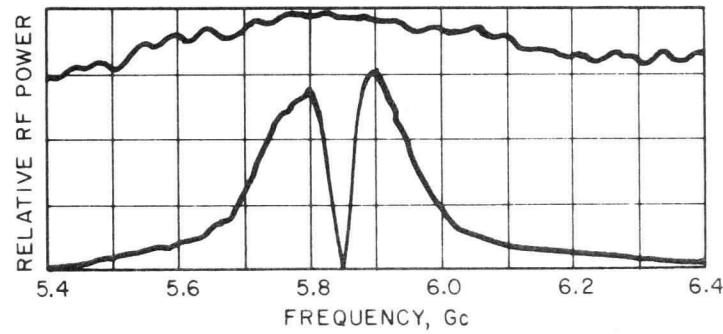
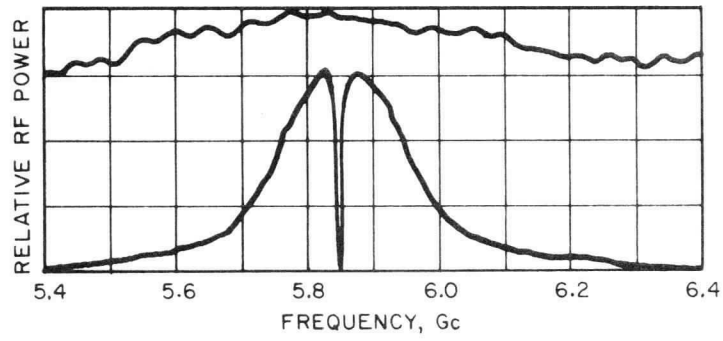
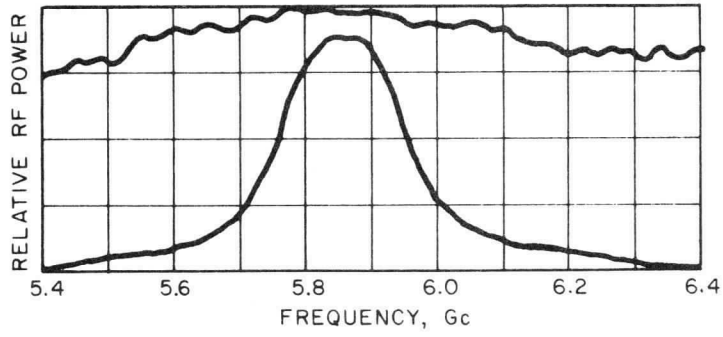

FIG. 3 - DISPLAYS OF THE PERFORMANCE OF A WJ-507-2 AT 5.85 Gc.

DEVELOPMENTAL SPECIFICATION

WJ-507-1

50 to 100 Mc bandwidth frequency-selective, phase-distortionless limiter, electrically tunable over 500 Mc, in 4 to 7.5 Gc range

These specifications have been derived from initial test results and should be used as criteria for planning purposes only.

ELECTRICAL

Center frequency	Anywhere within 4.0 to 7.5 Gc
Instantaneous bandwidth (3 db)	50 to 100 Mc
Low-level insertion loss at band-center	< 4 db
Input power at limiting	Approx. 1 mw
Limiting range	> 20 db
Frequency separation required for independent limiting of signals*	Approx. 4 Mc
Maximum phase variation over 20 db limiting range for a signal frequency at band center	$\pm 10^\circ$ objective

MECHANICAL

Diameter (excluding connectors)	2 3/4 inches
Height	2 1/8 inches
Weight	2 lbs
RF connectors	Type N

* Small signal reduced 3 db by large signal 3 db above limiting threshold.

Any further inquiries may be addressed to our Applications Engineering or to our representative in your area.

WATKINS-JOHNSON COMPANY
3333 Hillview Avenue
Palo Alto, California
DAvenport 6-8830

March 1962

DEVELOPMENTAL SPECIFICATION

WJ-507-2

200 Mc bandwidth frequency-selective limiter, fixed tuned in 4 to 7.5 Gc range

These specifications have been derived from initial test results and should be used as criteria for planning purposes only.

ELECTRICAL

Center frequency	Anywhere within 4.0 to 7.5 Gc (fixed tuned)
Instantaneous bandwidth (3 db)	200 Mc
Low-level insertion loss at band-center	< 2 db
Input power at limiting	Approx. 1 mw
Limiting range	> 20 db
Frequency separation required for independent limiting of signals*	Approx. 4 Mc

MECHANICAL

Diameter (excluding connectors)	2 3/4 inches
Height	2 1/8 inches
Weight	2 lbs
RF connectors	Type N

* Small signal reduced 3 db by large signal 3 db above limiting threshold.

Any further inquiries may be addressed to our Applications Engineering or to our Representative in your area.

WATKINS-JOHNSON COMPANY
3333 Hillview Avenue
Palo Alto, California
DAvenport 6-8830

March 1962

DEVELOPMENTAL SPECIFICATION

WJ-507-3

500 Mc bandwidth frequency-selective limiter, fixed-tuned in 4 to 7.5 Gc range

These specifications have been derived from initial test results and should be used as criteria for planning purposes only.

ELECTRICAL

Center frequency	Anywhere within 4.0 to 7.5 Gc (fixed tuned)
Instantaneous bandwidth (3 db)	500 Mc
Low-level insertion loss at band-center	< 1 db
Input power at limiting	Approx. 1 mw
Limiting range	> 20 db
Frequency separation required for independent limiting of signals *	Approx. 4 Mc

MECHANICAL

Diameter (excluding connectors)	2 3/4 inches
Height	2 1/8 inches
Weight	2 lbs
RF connectors	Type N

* Small signal reduced 3 db by large signal 3 db above limiting threshold.

Any further inquiries may be addressed to our Applications Engineering or to our Representative in your area.

WATKINS-JOHNSON COMPANY
3333 Hillview Avenue
Palo Alto, California
Davenport 6-8830

March 1962



Vol. 4, No. 10, October, 1962

THE WJ-519

Low-Power Ferrite Limiters

The WJ-519 is a low-power ferrite limiter designed for operation in C band. It utilizes the so-called coincidence mode of limiting in single-crystal lithium ferrite which results in limiting thresholds in the region of 1 milliwatt. Below this limiting threshold, the WJ-519 behaves as a bandpass filter with an insertion loss of about 1 db and a 3 db bandwidth of 500 Mc. The center frequency, which is fixed by a permanent magnet within the unit, can be set anywhere in the frequency range of 4500 to 6500 Mc.



Above the limiting threshold, frequency-selective limiting occurs. This is in contrast to the usual amplitude limiter which behaves as an instantaneous peak clipper, and thus has a peak output which is independent of the number and frequency distribution of the signals present. The frequency-selective ferrite limiter, however, will independently limit signals of different frequencies and will thus have a total output power which does depend on the number and frequency distribution of the signals present.

One important consequence of this frequency-selective property is that the presence of a large saturating signal in the pass-band of the limiter will not cause suppression of an adjacent small signal, as long as the two signals are separated by a few megacycles. This characteristic can be useful in microwave receivers since it would be very difficult to "block" such a receiver by a single strong signal in the pass-band.

Another consequence of this frequency-by-frequency limiting characteristic is that sum and difference frequencies are not generated when two large signals are simultaneously limited. Again the two signals must be separated by a few megacycles for this to be true.

Yet another useful characteristic of the WJ-519 is its minimum phase distortion above limiting threshold. Measurements at spot frequencies have indicated phase changes of less than $\pm 5^\circ$ over a 20 db limiting range.

Any further inquiries may be addressed to our Applications Engineering or to the representative in your area.

DEVELOPMENTAL SPECIFICATION

WJ-519

500 Mc bandwidth miniaturized frequency-selective limiter,
fixed-tuned in 4.5 to 6.5 Gc range

This Developmental Specification is subject to change without notice. It should not be used without the advice of Watkins-Johnson Applications Engineering regarding the current technical status of the item described.

ELECTRICAL

Center frequency	Anywhere within 4.5 to 6.5 Gc (fixed-tuned)
Instantaneous bandwidth (3 db)	500 Mc
Low-level insertion loss at band center	1 db
Input power at limiting	Approx. 1 mw
Limiting range	> 20 db
Frequency separation required for independent limiting of signals*	Approx. 4 Mc

MECHANICAL

Diameter (excluding connectors)	2 inches
Height	1.5 inches
Weight	10 oz.
RF connectors	Type N

* Small signal reduced 3 db by large signal 3 db above limiting threshold

WATKINS-JOHNSON COMPANY
Stanford Industrial Park
3333 Hillview Avenue
Palo Alto, California
Telephone: DAveport 6-8830

14 October 1962



Vol. 9. No 1; January 1967

WJ-569

YIG-TUNED L-BAND TRANSISTOR OSCILLATOR

The WJ-569 YIG-tuned transistor oscillator establishes a new family of lightweight, long-life, solid-state tunable oscillators. Extensive knowledge acquired in developing and producing the complete line of YIG (yttrium-iron-garnet) filters, covering the frequency range 0.5 to 18.0 GHz, is reflected in the advanced design of this oscillator.

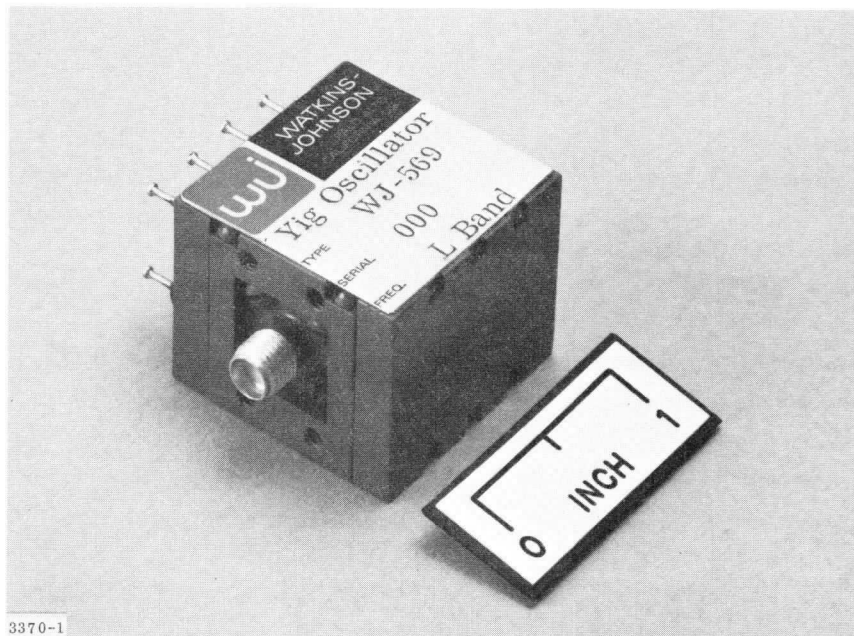

The WJ-569 is an extremely compact solid-state microwave signal source which is electronically tuned to cover a frequency range from 1.0 to 2.0 GHz. Differing from other tunable oscillators, the WJ-569 is YIG-tuned, thus enabling excellent linearity over the full octave while maintaining high temperature stability. YIG-tuned oscillators with wider bandwidth, greater power output, less power variation, greater sweep rate, and other special features can be made to order.

The frequency determining element of the WJ-569 oscillator is a YIG resonator. The resonant frequency of this device is directly proportional to the applied magnetic field. It is tuned by superposition of the field of a permanent magnet with that of an electromagnet. The permanent magnet determines the zero-current frequency of the oscillator which is normally set at band center. A bi-directional current through the electromagnet coils is used to vary the frequency from the zero-current value. The WJ-569 is magnetically shielded by means of a re-entrant magnetic assembly, producing

a negligible external magnetic field that is unaffected by severe magnetic environments.

A YIG-driver supply is available which allows voltage tuning of the oscillator from a high-impedance, low-voltage source. For applications requiring maximum frequency stability, a control circuit can be supplied which provides constant temperature at the YIG resonator over a large ambient temperature range. A small heating element and a temperature-sensing thermistor are mounted inside the assembly close to the YIG resonator.

Additional information on the WJ-569 may be obtained through our representative in your area, or by contacting Watkins-Johnson Company, 3333 Hillview Avenue, Palo Alto, California. Inquiries to our Palo Alto facility should be addressed to the attention of Applications Engineering.

TENTATIVE SPECIFICATION

WJ-569

YIG-TUNED L-BAND TRANSISTOR OSCILLATOR

<u>RF PERFORMANCE</u>	<u>Typical</u>	<u>Guaranteed</u>
Nominal Frequency Band	1.0 - 2.0 GHz	
Power Output into Load VSWR = 1.25	15 - 40 mW	10 mW, min.
Power Output Variation	4 dB	6 dB, max.
Fine Gain, Variation		1.5 dB/50 MHz, max.
Spurious Oscillation		
Ratio of Signal to 2nd Harmonic Output	30 dB	20 dB, min.
Ratio of Signal to all other Spurious Outputs	60 dB	50 dB, min.
Output Impedance	50 ohms	
Sensitivity to Supply Voltage	0.3 MHz/V	1 MHz/V, max.
Residual FM, Peak to Peak	5 kHz	10 kHz, max.
Frequency Drift, -30°C to 65°C	5 MHz	10 MHz, max.
Pulling Figure, VSWR 1.5:1 at any phase	5 MHz	12 MHz, max.
 <u>TUNING CHARACTERISTICS</u>		
Sweep Rate	100 Hz	
Tuning Power, Center Biased		0.4 W, max.
Tuning Linearity	± 0.1%	± 0.3%, max.
Zero-Current Frequency	1.5 GHz	
Tuning Sensitivity	300 MHz/100 mA	200 MHz/100 mA, min.
Tuning Voltage	2.0 V	3.0 V, max.
 <u>ELECTRICAL REQUIREMENTS</u>		
Oscillator Voltage	20 V	25 V, max.
Oscillator Current	40 mA	50 mA, max.
YIG Heater Power at -30°C	4 W	6 W, max.

TENTATIVE SPECIFICATION (cont'd)

MECHANICAL CHARACTERISTICS

Size, Excluding RF Connector, (width x length x height)	1.2 x 1.2 x 1.0 inches, max.
Weight, Including Magnetic Shielding	5 ounces, max.
RF Output Connection	OSM Female
Power Input	Solder Terminals, with RFI shielding.

WATKINS-JOHNSON COMPANY
Stanford Industrial Park
3333 Hillview Avenue
Palo Alto, California

Telephone: (415) 326-8830
Teletype: 910-373-1253
Telex: 348-415

January, 1967

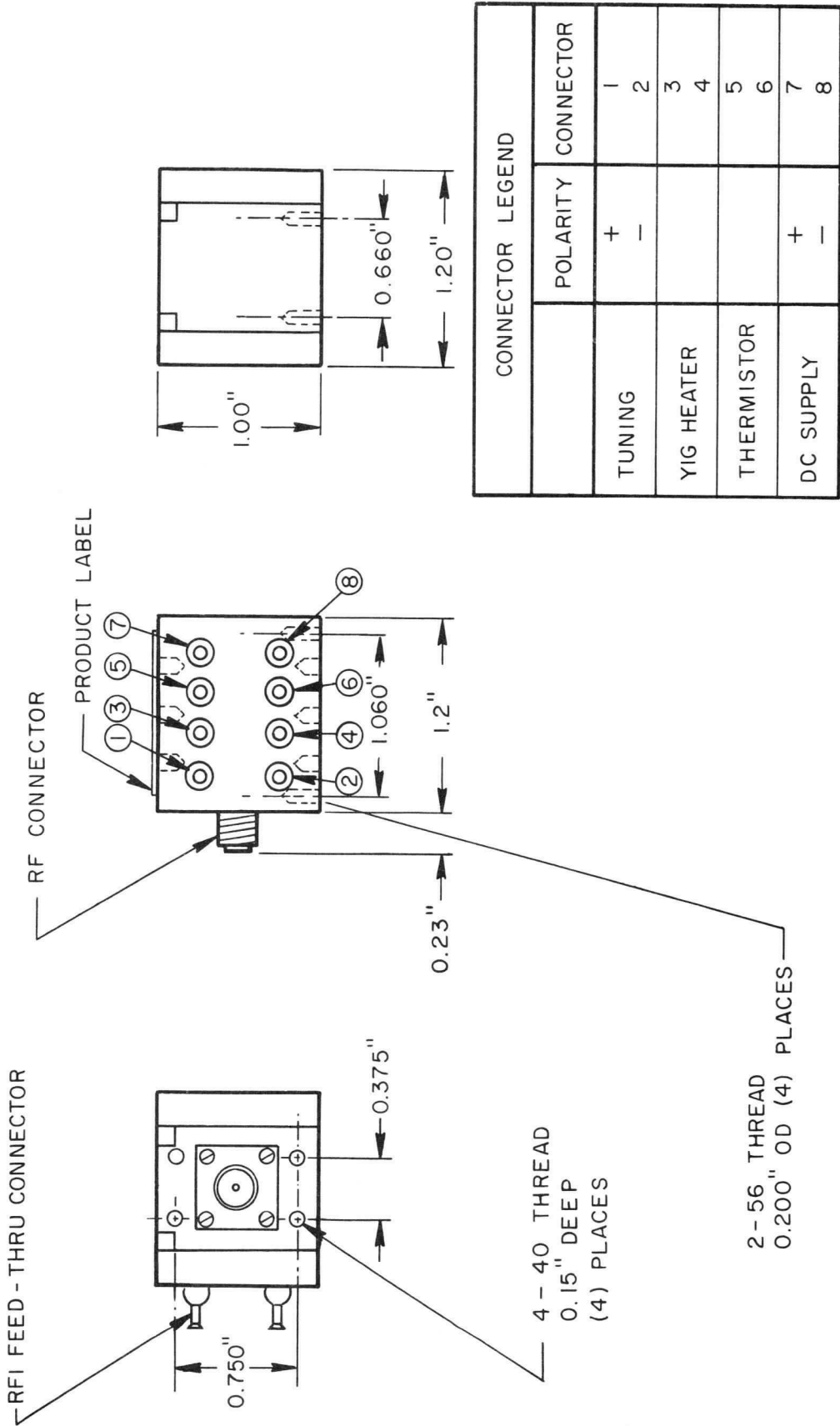
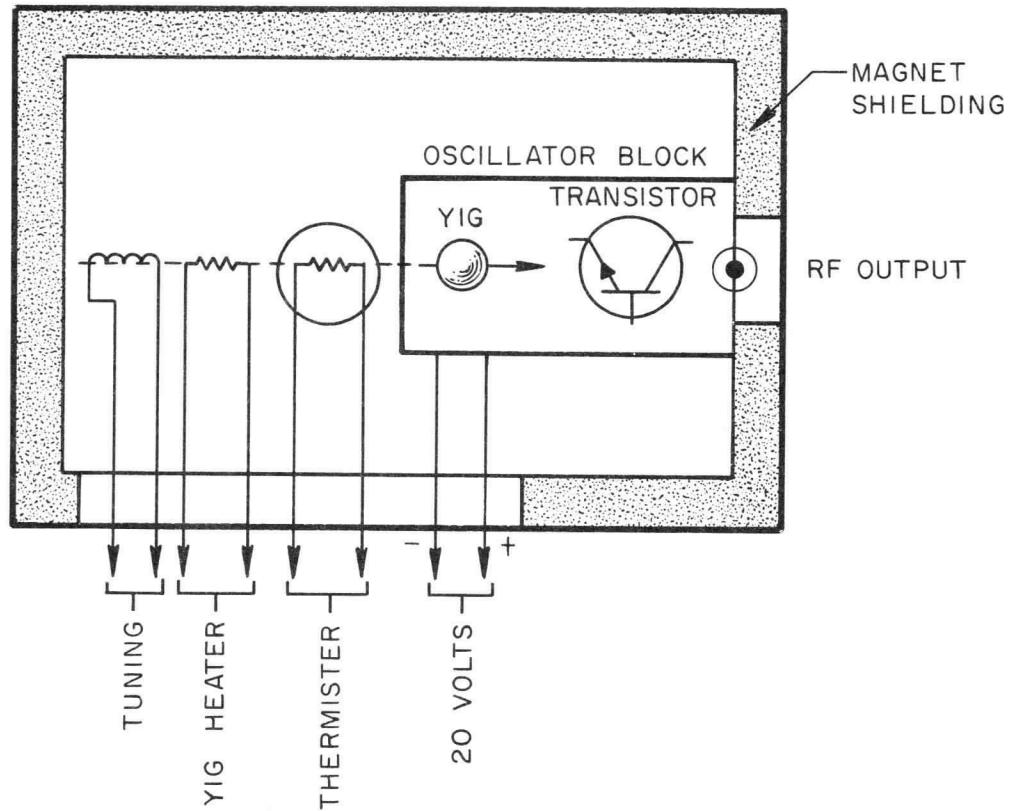
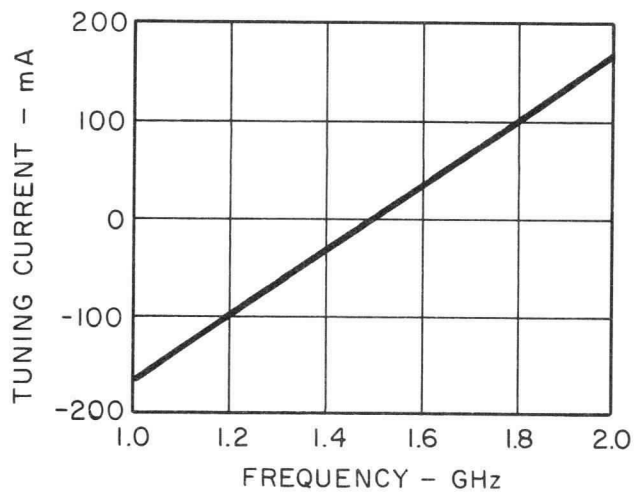

FIG. 1. WJ - 569 OUTLINE DRAWING AND MOUNTING DIMENSIONS



SCHEMATIC DIAGRAM



TUNING CURRENT

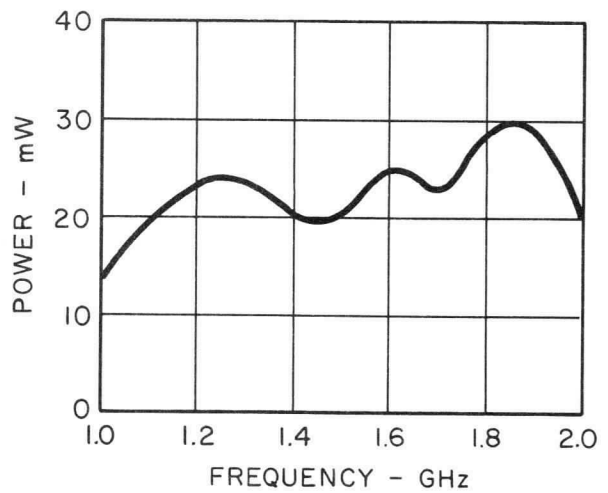

POWER OUTPUT

FIG. 2. WJ-569 TYPICAL POWER OUTPUT, TUNING CURRENT, AND SCHEMATIC DIAGRAM

TENTATIVE SPECIFICATION

Watkins-Johnson Part No. WJ-913

High Power, Water-Cooled, K_a-Band Attenuators

Attenuation	0 to 30 db (to customer's specification)
Calibration accuracy	±5 percent
Maximum power capability	2 kw CW or 500 kw peak pressurized to 2 atmospheres
Frequency range	26-40 Gc
Waveguide	RG-96/U with UG 599/U flanges
VSWR	1.15:1 max.
Coolant flow rate	0.3 GPM nominal (Can be varied for calorimetric power measurements)
Length	12 inches - flange to flange



Vol. 8, No. 3, January 1966

WJ-1016

FALLING RASTER DISPLAY

Watkins-Johnson's WJ-1016 Falling Raster Display provides a direct view, three-dimensional panoramic presentation of receiver signals. Designed for use with a scanning search receiver, the WJ-1016 makes use of a raster scan and beam intensity modulation to provide signal information of frequency, time, and amplitude. This information is displayed simultaneously on a ten-inch controlled-persistence cathode-ray-tube. This tube, as used in the WJ-1016, enables dynamic erasure of stored information variable over a range from 5 seconds to 10 minutes.

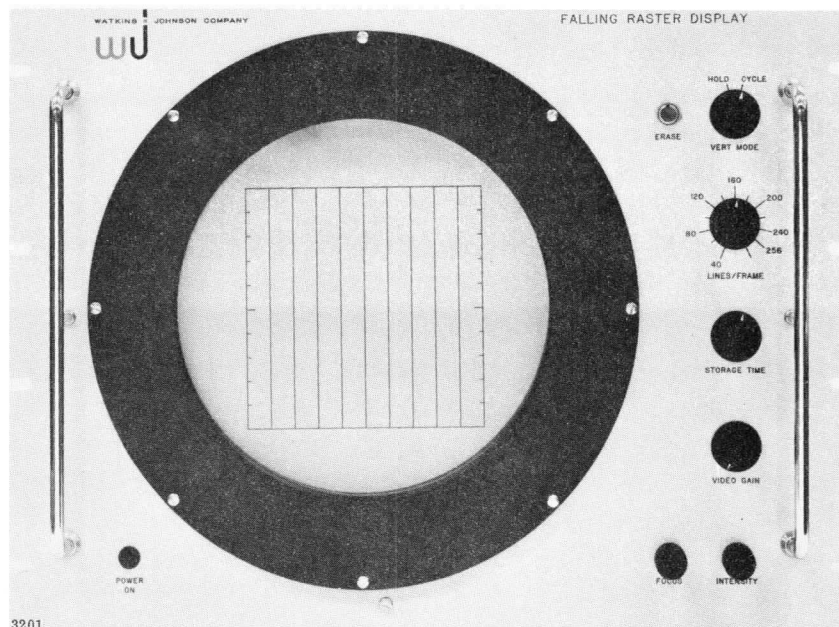

Horizontal sweeping and triggering of the Falling Raster Display are required from a scanning receiver. The WJ-1016's vertical sweep is synchronized to the horizontal sweep in such a manner that at the end of each horizontal sweep, a trigger pulse from the scanning receiver "steps" the electron beam vertically by a small amount. The stepping process is repeated after each horizontal sweep until a vertical staircase is created across the 5.25-inch field of the CR tube's graticule. The stepping magnitude is adjustable from 40 to 256 line-pairs (vertically) across the CR tube screen, yielding a maximum resolution of approximately 50 line-pairs/inch. In order to assure highly

stable and repeatable sweeping that is independent of the horizontal sweeping rate, generation of the vertical sweep voltage is accomplished through D-A conversion of the output from a 9-bit flip-flop counter.

The raster automatically recycles to the "top" of the staircase at the end of each cycle unless acted upon by the WJ-1016's holding function. This holding function, as well as the magnitude of incremental stepping, is under control of the operator. A positive 2-volt pulse, supplied from the scanning receiver, blanks out the video presentation during retrace of both horizontal and vertical sweeps.

Video information is applied as beam intensity modulation in a manner such that signal amplitudes are presented as shades of beam intensity. The use of the controlled-persistence CR tube permits integration of signals out of noise. This SNR enhancement is a result of the vertical sweep repeatability coupled with the inherent integrating properties of the CR tube. Appropriate circuitry is included to give the WJ-1016 equipment a dynamic signal range of 20 dB without visual indication of spurious response or signal overloading.

All functional units of the Falling Raster Display, except the CR tube, are solid-state. The use of conservatively-rated components, including all silicon transistors, assures the same reliable long-term operation characteristic of all Watkins-Johnson electronic systems and devices.

Additional information on the WJ-1016 may be obtained through our representative in your area, or by contacting Watkins-Johnson Company, 3333 Hillview Avenue, Palo Alto, California. Inquiries to our Palo Alto facility should be addressed to the attention of Applications Engineering.

TENTATIVE SPECIFICATION
WJ-1016
FALLING RASTER DISPLAY

<u>DISPLAY CHARACTERISTICS</u>	<u>Minimum</u>	<u>Maximum</u>
Calibrated Display Area	27.6 in ²	
Resolution (adjustable)	7.6 line-pairs/inch	49.7 line-pairs/inch
Brightness (adjustable)	0 fL	400 fL
Storage Time (adjustable)	5 sec	10 min
Erase Time	400 ms	
Dynamic Input (video) Range	20 dB	
 <u>INPUT REQUIREMENTS</u>		
<u>Typical</u>		
Horizontal Sweep		
Amplitude	2.0 V p-p	
Rate	0.017 - 100 c/s	
Rise Time	6.0 μ sec	
Linearity	1%	
Retrace Time	100 μ sec	
Impedance	2,000 ohms	
Master Trigger Pulse		
Amplitude	10.0 V p-p	
Duration	2.0 μ sec	
Impedance	50 ohms	
Blanking Pulse Amplitude	+2.0 V into 50-ohm load	
Video Signal		
Amplitude	+2.0 V into 93-ohm load	
Bandwidth	10 c/s to 500 kc/s	
Dc Voltages*	+30 \pm 0.5 V @ 1.5 A	
	-30 \pm 0.5 V @ 0.8 A	
	+100 \pm 1.0 V @ 0.4 A	
	+6.3 \pm 0.3 V @ 1.5 A	
Ac Voltage*	115 \pm 10 V @ 0.1 A	
 <u>MECHANICAL</u>		
Dimensions (for rack mounting)	14" high x 19" wide x 21-1/2" deep	
Weight	50 pounds	
Controls	POWER ON, FOCUS, INTENSITY, VIDEO GAIN, STORAGE TIME, LINES/ FRAME, VERT MODE, and ERASE	
Connectors	Dc Input: Deutsch DM9702-12P Ac Input: Deutsch DM9702-3P Video Input: Deutsch DM9702-12P All Other Inputs: BNC	

* These voltages can be supplied by the optional WJ-1017 Display Power Supply unit.

WATKINS-JOHNSON COMPANY
Stanford Industrial Park
3333 Hillview Avenue
Palo Alto, California

January 1966

Telephone: (415)326-8830
Teletype: (910)373-1253

STEWART ENGINEERING COMPANY

CONTENTS

Backward-Wave Oscillators

(Permanent-Magnet Focused)

Backward-Wave Oscillators

(Solenoid Focused)

GENERAL SALES INFORMATION

ORDERING

All orders should be addressed to Stewart Engineering Company, 467 Bean Creek Road, Santa Cruz, California, or to our representative in your area. Inquiries about our products may be addressed in the same manner.

SHIPPING

All shipments are made f. o. b. our plant, Santa Cruz, California. If method of shipment is not specified by purchaser, items will be shipped best way at the discretion of the seller.

DELIVERY

Delivery schedules will vary depending upon product and quantity ordered. Stewart Engineering will attempt to meet the delivery schedule buyer requests. We recommend you contact our representative or Stewart Engineering Company, at the time of order placement, for firm delivery information.

RETURNS

Merchandise may be returned for adjustment only with prior approval from Stewart Engineering Company. Before any action can be taken on returned merchandise, the warranty information form must be completed and returned. It is requested that these reports be packed with the items returned.

PRICES

All prices are subject to change without notice. Quantity prices are offered on standard items, and are quoted on request.

TERMS

Terms of payment are net 30 days.

WARRANTIES

All Stewart products are thoroughly tested and inspected prior to shipment and are warranted to perform satisfactorily in accordance with the Conditions of Warranty applicable to the specific item.

APPLICATIONS ENGINEERING

Stewart Engineering's staff of Applications Engineers is available as a service to you, the customer. They are well versed on the applications of Stewart Engineering products and will be happy to serve you.

November, 1963
Stewart Engineering Company

TABLE OF CONTENTS

Stewart Backward-Wave Oscillators

<u>Permanent-Magnet Focused Backward-Wave Oscillators</u>	<u>Effective Date</u>
SE 201	August, 1963
SE 201-A	August, 1963
SE 203	August, 1963
SE 204-A	October, 1963
SE 205	August, 1963
SE 205-A	August, 1963
SE 206	October, 1963
SE 206-A	August, 1963
SE 209	July, 1963
SE 209-A	July, 1963
SE 211-A	October, 1963
SE 213 + 215A	August, 1963
SE 301	August, 1963
SE 302	August, 1963
SE 303	October, 1963

Solenoid-Focused Backward-Wave Oscillators

Short-Form Listing - Solenoid-Focused Tubes

OD 1-2B	August, 1963
OD 1-2.6	August, 1963
OD 2-4	August, 1963
OD 4-8	August, 1963
OD 5.4-6.0	August, 1963
OD 7-13	August, 1963
OD 12-18B	August, 1963
OD 18-27	August, 1963

Information contained herein is subject to change without notice. It should not be used without the advice of Stewart Applications Engineering regarding the current technical status of the item described.

Any further inquiries should be addressed to Stewart Engineering Company Applications Engineering, Santa Cruz, California, telephone 408-426-4100, TWX number 408-423-7545, or to our representative in your area.

November, 1963
Stewart Engineering Company

BACKWARD-WAVE OSCILLATORS
(PERMANENT-MAGNET FOCUSED)

BACKWARD-WAVE OSCILLATOR

The Type SE 201 BWO is a single-helix, voltage tunable oscillator. This permanent-magnet-focused wideband oscillator is well suited for use as a swept signal source in signal generators, particularly in view of its high stability. Other applications include radar receivers (as local oscillator), frequency diversity transmitters (as master oscillator), and ECM equipment. The SE 201 features smooth power over the band, low cathode current, and two control electrodes. The control grid makes possible power cutoff with low negative grid voltage. Power output can be modulated with either the grid or anode, or both. Cathode modulation with the grid grounded usually reduces FM caused by AM. With all voltages isolated from both tube housing and the r.f. output terminal, packaging problems are simplified, since the tube housing and output connector can be grounded regardless of power supply configuration.

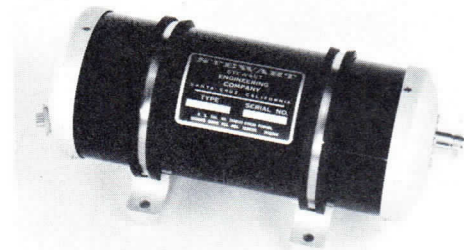

ELECTRICAL CHARACTERISTICS, CW

	Typical Values	Absolute Ratings
Nominal Frequency Band, Gc	7.0-12.4	*
Power Output (Load VSWR=1.25), mW	12-55	10 Min.
Power Output Variation, db		10 Max.
Fine Grain Variation, db/250 mc		3 Max.
Tube VSWR		2:1 Max.
Ratio of Signal to Total Spurious Output, db	60	45 Min.
Long-term sensitivity to Heater Voltage, Mc/V	7.5	10 Max.
Sensitivity to Anode Voltage, Mc/V	0.5	1.0 Max.
Sensitivity to Grid Voltage, Mc/V	2	4 Max.
Tuning Curve Slope, Mc/V		
Low End (7.0 Gc)	8.5	
Mid-Frequency (9.7 Gc)	3.9	
High End (12.4 Gc)	1.5	
Grid r.f. Cutoff Voltage, V	-10	-20 Max.
Capacitance; Cathode to all other Electrodes inc. Heater, uuf	28	35 Max.
Capacitance; Grid to all other Electrodes, at Power Input Connector, uuf	28	35 Max.
Capacitance; r.f. connector center pin and Housing to all other Electrodes, uuf	135	150 Max.

11/63

* Selected tubes with extra power, extra bandwidth, lower power variation and other features are normally available on special order. These are design data only. For operating instructions refer to Stewart Instruction Sheet furnished with tube.

ELECTRICAL CHARACTERISTICS, CW (Contd.)

	Typical Values	Absolute Ratings
Heater Voltage, V		6.3 ± 5%
Heater Current, A	0.9	0.6-1.2 Min/Max.
Heater-to-Cathode Leakage ($E_{hk} = -90V$), μA		25 Max.
Cathode Current	9	12 Max.
Helix Voltage Range, V	310-2000	250-2100 Min/Max.
Helix Current, mA	1.5	3 Max.
Anode Voltage, V	160	250 Max.
Anode Current, mA	1	2 Max.
Anode Supply Impedance		50K Max.

MECHANICAL DATA

Length, exclusive of Connectors, In.	9-1/2 Max.
Height, In.	4-1/4 Max.
Weight, Lbs.	11 Max.
R.F. Output Connector	Type N Female
Power Input Connector	Deutsch DM-5605-7P
Forced Air Cooling, to +60°C Ambient	None required
Mounting Position	Any
Separation from Passive Magnetic Materials, In.	2 Min.

SCHEMATIC DIAGRAM

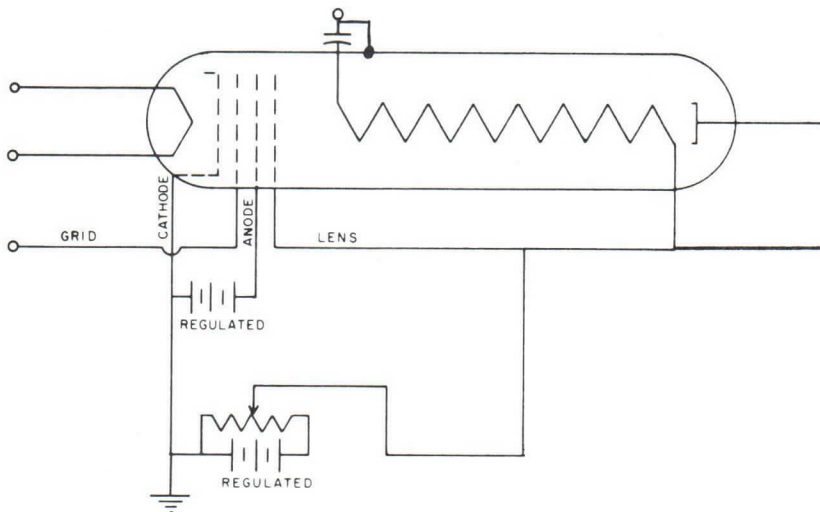

TUNING VOLTAGE

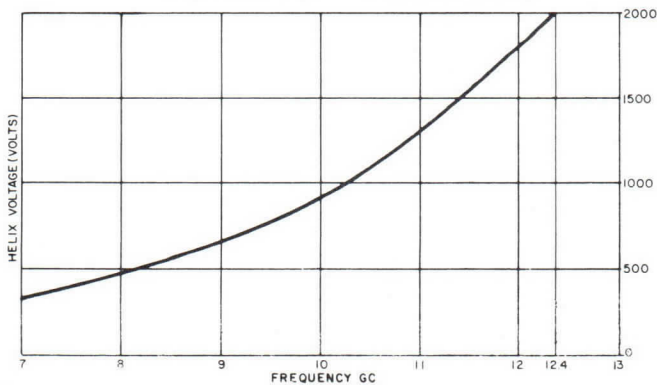

POWER OUTPUT

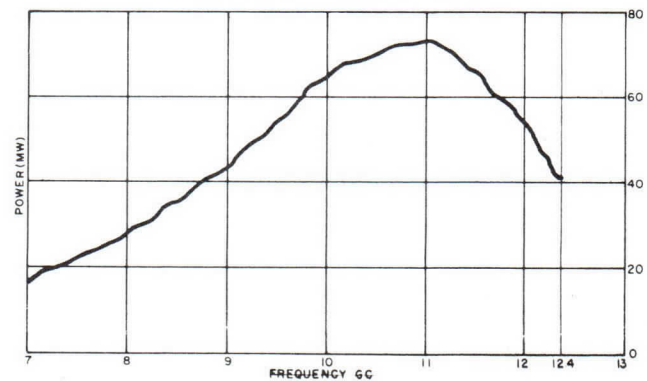

Vol. 1, No. 2; August, 1963

SE-201 and SE-201A

X-BAND BACKWARD-WAVE OSCILLATORS

The SE-201 and SE-201A are wide-band voltage-tunable "O" type oscillators utilizing tubular permanent magnets.

They are used chiefly as swept signal sources, local oscillators in radar receivers and in countermeasures systems, and master oscillators in broadband transmitters.

All voltages are isolated from the external housing and the rf output connector, and either the grid or anode, or both may be used for rf power leveling or for modulation purposes.

They use monofilar helices for the slow-wave structure and employ closely coupled hollow electron beams for maximum efficiency with minimum collector dissipation. The total power input under normal operation is less than 20 watts. This is less than one-fifth the power requirement for an equivalent solenoid focused tube.

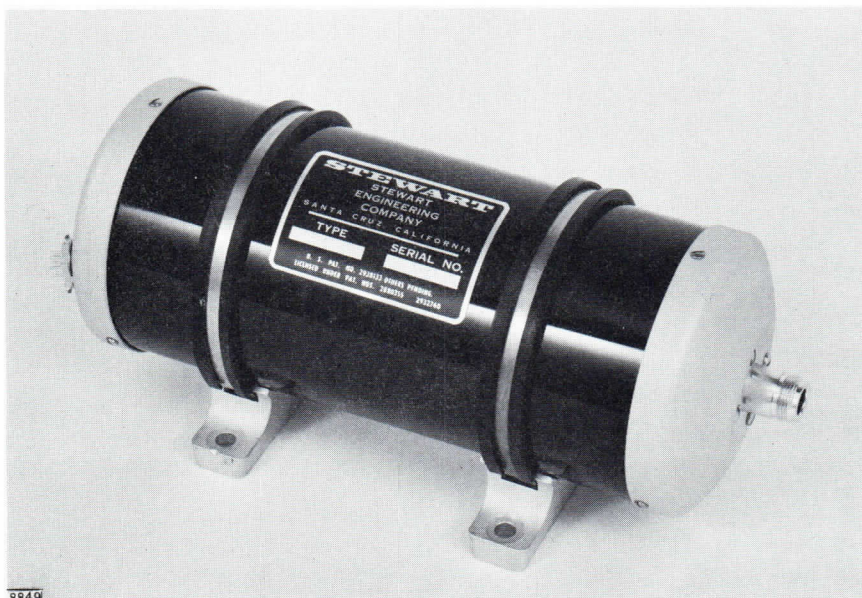

The helix voltage ranges are chosen consistent with power output requirement and minimum sensitivity to ripples in the operating power supplies.

The SE-201 and SE-201A require no external cooling while operating in high ambient temperatures. They may be mounted in any position without affecting operating life.

Further inquiries may be addressed to the Stewart Marketing Department or to our representative in your area.

SPECIFICATION

SE-201 and SE-201A

X-BAND BACKWARD-WAVE OSCILLATORS

<u>PERFORMANCE</u>	<u>SE-201</u>	<u>SE-201A</u>
Frequency	7-12.4 Gc	8.2-12.4 Gc
Power output	10 mw min.	20 mw min.
Power output variation	10 db max.	6 db max.
Tube VSWR	2.5:1 max.	2.5:1 max.
 <u>ELECTRICAL REQUIREMENTS</u>		
Helix voltage	310-2000 v typ.	500-2000 v typ.
Anode voltage	160 v typ.	150 v typ.
Heater voltage	6.3 ± 5% v	6.3 ± 5% v
Heater current	0.6-1.2 a min/max.	0.6-1.2 a min/max.
Cathode current	12 ma max.	12 ma max.
 <u>MECHANICAL</u>		
Over-all length	10 1/2 inches max.	10 1/2 inches max.
Weight	11 lbs. max.	11 lbs. max.
Output connector	N female	N female
Power input connector	Deutsch DM-5605-7P	Deutsch DM-5605-7P

STEWART ENGINEERING COMPANY
467 Bean Creek Road
Santa Cruz, California

Telephone: Area Code 408
426-4100

1 August 1963

BACKWARD-WAVE OSCILLATOR

The Type SE 201A BWO is a single-helix, voltage tunable oscillator. This permanent-magnet-focused wideband oscillator is well suited for use as a swept signal source in signal generators, particularly in view of its high stability. Other applications include radar receivers (as local oscillator), frequency diversity transmitters (as master oscillator), and ECM equipment. The SE 201A features smooth power over the band, low cathode current, and two control electrodes. The control grid makes possible power cutoff with low negative grid voltage. Power output can be modulated with either the grid or anode, or both. Cathode modulation with the grid grounded usually reduces FM caused by AM. With all voltages isolated from both tube housing and the r.f. output terminal, packaging problems are simplified, since the tube housing and output connector can be grounded regardless of power supply configuration.

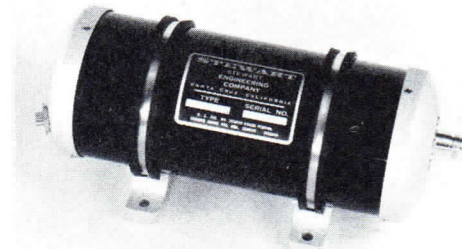

ELECTRICAL CHARACTERISTICS, CW

	Typical Values	Absolute Ratings
Nominal Frequency Band, Gc	8.2-12.4	*
Power Output into Load with VSWR=1.25, mW	25-50	20 Min.
Power Output Variation, db		6 Max.
Fine Grain Variation, db/250 mc		3 Max.
Tube VSWR		2:1 Max.
Ratio of Signal to Total Spurious Output, db	60	45 Min.
Long-term sensitivity to Heater Voltage, Mc/V	7.5	10 Max.
Sensitivity to Anode Voltage, Mc/V	0.5	1.0 Max.
Sensitivity to Grid Voltage, Mc/V	2	4 Max.
Tuning Curve Slope, Mc/V		
Low End (8.2 Gc)	7.0	
Mid-Frequency (10.3 Gc)	3.5	
High End (12.4 Gc)	1.5	
Grid r.f. Cutoff Voltage, V	-10	-20 Max.
Capacitance; Cathode to all other Electrodes inc. Heater, uuf	28	35 Max.
Capacitance; Grid to all other Electrodes, at Power Input Connector, uuf	28	35 Max.
Capacitance; r.f. connector center pin and Housing to all other Electrodes, uuf	135	150 Max.

11/63

ELECTRICAL CHARACTERISTICS, CW (Contd.)

Heater Voltage, V
 Heater Current, A
 Heater-to-Cathode Leakage ($E_{hk} = -90V$), μA
 Cathode Current, mA
 Helix Voltage Range, V
 Helix Current, mA
 Anode Voltage, V
 Anode Current, mA
 Anode Supply Impedance, Ohms

Typical
 Values

Absolute
 Ratings

		$6.3 \pm 5\%$
0.9		0.6-1.2 Min/Max.
		25 Max.
8		12 Max.
500-2000		450-2100 Min/Max.
1.5		3 Max.
150		250 Max.
0.5		2 Max.
		50K Max.

MECHANICAL DATA

Length, exclusive of Connectors, In.
 Height, In.
 Weight, Lbs.
 R.F. Output Connector
 Power Input Connector
 Forced Air Cooling, to $+60^{\circ}C$ Ambient
 Mounting Position
 Separation from Passive Magnetic Materials, In.

9-1/2 Max.
 4-1/4 Max.
 11 Max.

Type N Female
 Deutsch DM-5605-7P
 None Required
 Any
 2 Min.

SCHEMATIC DIAGRAM

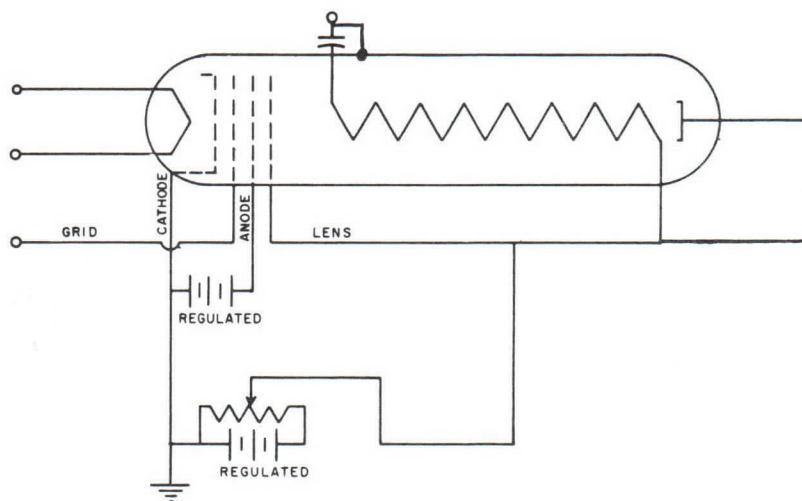

TUNING VOLTAGE

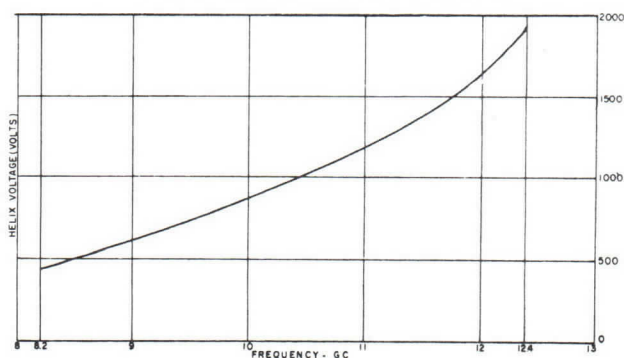

POWER OUTPUT

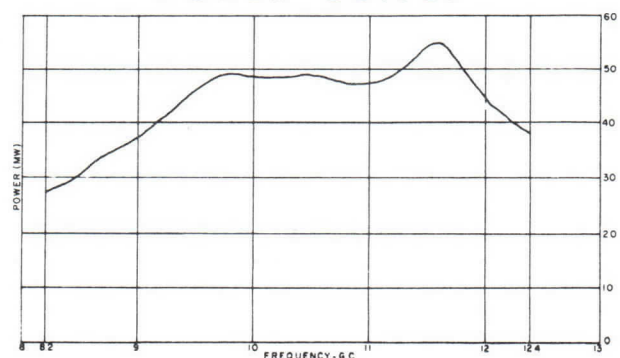

BACKWARD-WAVE OSCILLATOR

The Type SE 203 BWO is a single-helix, voltage tunable oscillator. This permanent-magnet focused wide band oscillator is well suited for use as a swept signal source in signal generators, particularly in view of its high stability. Other applications include ECM receivers (as local oscillator), frequency diversity transmitters (as master oscillator), and other electronic equipment. The SE 203 features smooth power over the band, low cathode current, and two control electrodes. The control grid makes possible power cutoff with low negative grid voltage. Power output can be modulated with either the grid or anode, or both. Cathode modulation with the grid grounded usually reduces FM caused by AM. With all voltages isolated from both tube housing and the r.f. output terminal, packaging problems are simplified, since the tube housing and output connector can be grounded regardless of power supply configuration.

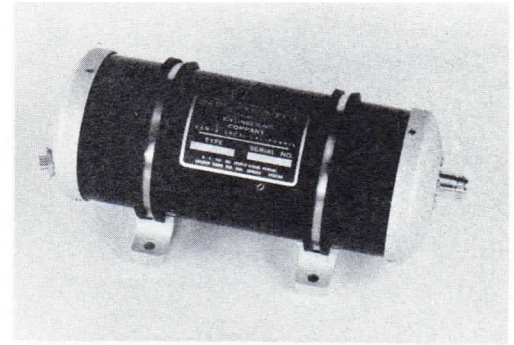

ELECTRICAL CHARACTERISTICS, CW

	Typical Values	Absolute Ratings
Nominal Frequency Band, Gc	5.3-6.0	*
Power Output into Load with VSWR = 1.25, mW	120-160	100 Min. 3 Max.
Power Output Variation, db		3 Max.
Fine Grain Variation, db/100Mc		1.5 Max.
Tube VSWR		2:1 Max.
Ratio of Signal to Total Spurious Output, db		40 Min.
Spurious output in 2 Mc bands, 30 Mc on each side of carrier, db below carrier	90-100	85 Min.
Long-term sensitivity to Heater Voltage, Mc/V	1.5	2.0 Max.
Sensitivity to Anode Voltage, Mc/V	0.5	1.0 Max.
Sensitivity to Grid Voltage, Mc/V	2.5	5.0 Max.
Tuning Curve Slope, Mc/V		
Low End (5.3 Gc)	3.3	
Mid-Frequency (5.65 Gc)	2.8	
High End (6.0 Gc)	2.3	
Grid r.f. Cutoff Voltage, V	-10	-20 Max.
Capacitance; Cathode to all other Electrodes including Heater, uuf	18	25 Max.
Capacitance; Grid to all other Electrodes, at Power Input		
Connector, uuf	12	20 Max.
Capacitance; Helix to all other Electrodes and Housing, uuf	135	160 Max.

11/63

* Selected tubes with extra power, extra bandwidth, lower power variation and other features are normally available on special order. These are design data only. For operating instructions refer to Stewart Instruction Sheet furnished with tube.

ELECTRICAL CHARACTERISTICS, CW (Contd.)

Typical Values

Absolute Ratings

Heater Voltage, V		6.3 ± 5%
Heater Current, A	1.0	1.2 Max.
Heater-to-Cathode Leakage ($E_{hk} = +90V$), μA		25 Max.
Cathode Current, mA	14	20 Max.
Helix Voltage Range, V	480-740	440-800 Min/Max.
Helix Current, mA	5	8 Max.
Anode Voltage, V	100	200 Max.
Anode Current, mA	0.7	2.0 Max.
Anode Supply Impedance, Ohms		50K Max.

MECHANICAL DATA

Length, exclusive of Connectors, In.	9-1/4 Max.
Height, In.	4-1/4 Max.
Weight, Lbs.	9.5 Max.
Separation from Magnetic Materials, In.	2 Min.
R.F. Output	End-cap mounted Type N Connector
Power Input Connector	Deutsch DM-5605-7P
Forced Air Cooling, to +60°C Ambient	None required
Mounting Position	Any

SCHEMATIC DIAGRAM

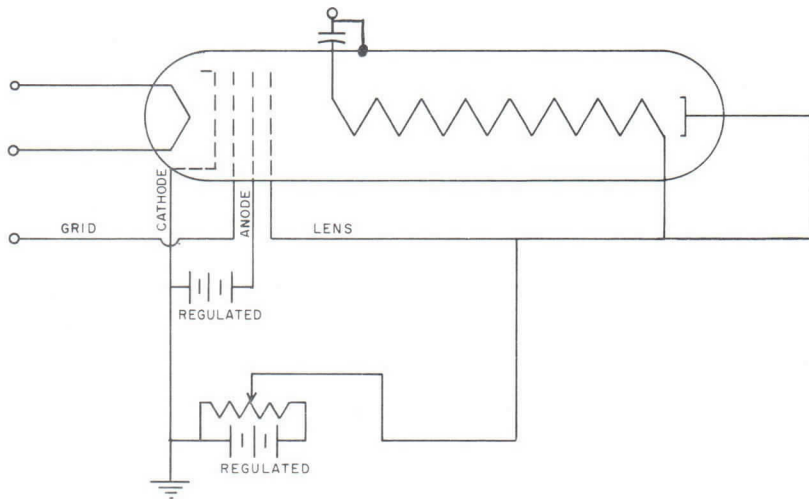

TUNING VOLTAGE

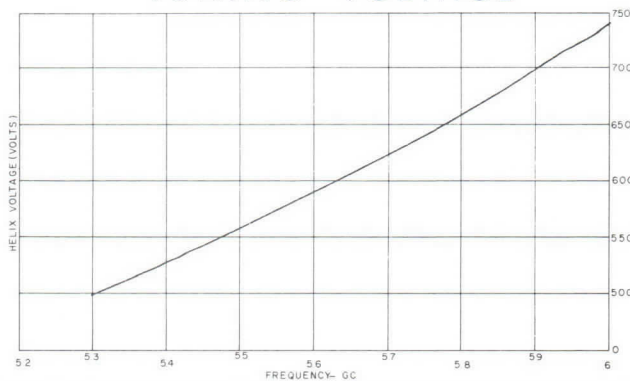

POWER OUTPUT

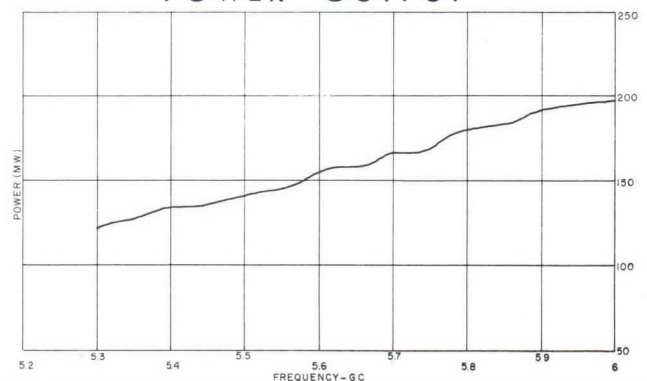

BACKWARD-WAVE OSCILLATOR

The Type SE 204 A BWO is a bifilar (dual helix), voltage tunable oscillator. This permanent-magnet focused wide band oscillator is well suited for use as a swept signal source in signal generators, particularly in view of its high stability. Other applications include ECM receivers (as local oscillator), frequency diversity transmitters (as master oscillator), and other electronic equipment. The SE 204 A features smooth power over the band, low cathode current, and two control electrodes. The control grid makes possible power cutoff with low negative grid voltage. Power output can be modulated with either the grid or anode, or both. Cathode modulation with the grid grounded usually reduces FM caused by AM. With all voltages isolated from both tube housing and the r.f. output terminal, packaging problems are simplified, since the tube housing and output connector can be grounded regardless of power supply configuration.

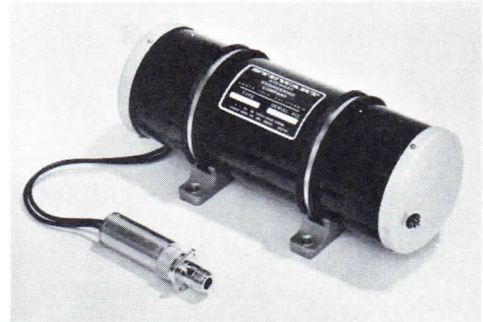

ELECTRICAL CHARACTERISTICS, CW

	Typical Values	Absolute Ratings
Nominal Frequency Band, Gc	1.0-2.0	*
Power Output into Load VSWR = 1.25, mW	85-250	50 Min. 8 Max.
Power Output Variation, db		3 Max.
Fine Grain Variation, db/50mc		2.5:1 Max.
Tube VSWR		
Spurious Oscillation		
Ratio of Signal to 2nd Harmonic Output, db	35	20 Min.
Ratio of Signal to all other Spurious Output, db	60	45 Min.
Long-term sensitivity to Heater Voltage, Mc/V	4	8 Max.
Sensitivity to Anode Voltage, Mc/V	0.3	0.7 Max.
Sensitivity to Grid Voltage, Mc/V	1.5	5 Max.
Tuning Curve Slope, Mc/V		
Low End (1.0 Gc)	2.4	
Mid-Frequency (1.5 Gc)	1.4	
High End (2.0 Gc)	.8	
Grid r.f. Cutoff Voltage, V	-7	-20 Max.
Capacitance; Cathode to all other Electrodes Including Heater, uuf	15	25 Max.
Capacitance; Grid to all other Electrodes, at Power Input Plug, uuf	20	25 Max.
Capacitance; Helix to all other Electrodes (12" Coax Cable Attached), uuf	250	300 Max.

ELECTRICAL CHARACTERISTICS, CW (Contd.)

Heater Voltage, V
 Heater Current, A
 Heater-to-Cathode Leakage ($E_{hk} = \pm 90$ V), μ A
 Cathode Current, mA
 Helix Voltage Range, V
 Helix Current, mA
 Anode Voltage, V
 Anode Current, mA
 Anode Supply Impedance, Ohms

Typical
 Values

Absolute
 Ratings

		6.3 \pm 5%
0.85		1.2 Max.
		25 Max.
12		17 Max.
240-1000		220-1050 Min/Max
1.5		4.0 Max.
140		250 Max.
0.8		1.5 Max.
		50K Max.

MECHANICAL DATA

Length, exclusive of Connectors, In.
 Height, In.
 Weight, Lbs.
 Output Cable Length (Type N Connector), In.
 Power Input Connector
 Forced Air Cooling to +60°C Ambient
 Mounting Position
 Separation from Magnetic Materials, In.

10-3/4 Max.
4-1/4 Max.
12.5 Max.
12
Deutsch DM-5605-7P
None required
Any
2 Min.

SCHEMATIC DIAGRAM

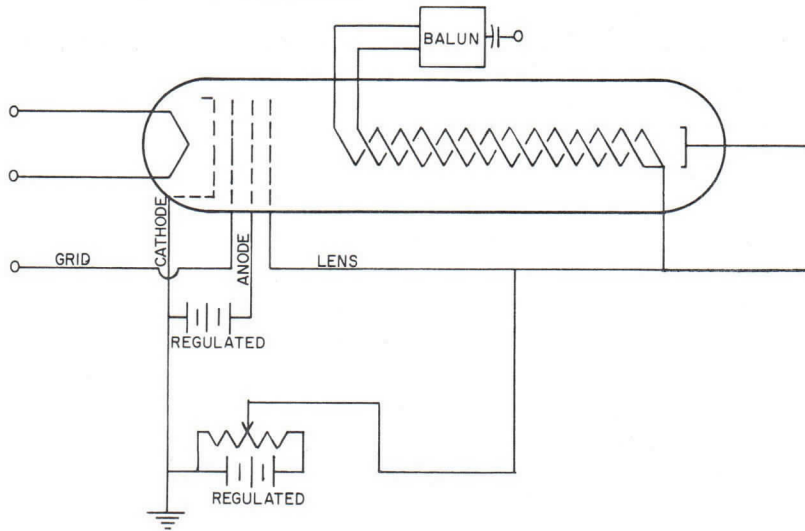

TUNING VOLTAGE

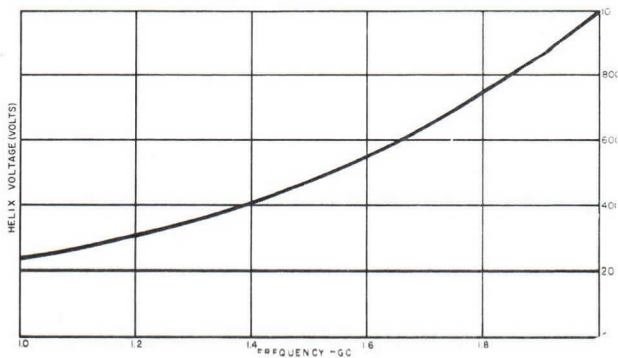

POWER OUTPUT

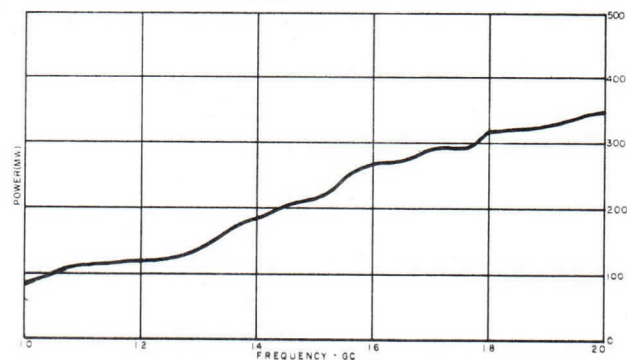

BACKWARD-WAVE OSCILLATOR

The Type SE 205 BWO is a bifilar (dual helix), voltage tunable oscillator. This permanent-magnet focused wide band oscillator is well suited for use as a swept signal source in signal generators, particularly in view of its high stability. Other applications include radar receivers (as local oscillator), frequency diversity transmitters (as master oscillator), and ECM equipment. The SE 205 features smooth power over the band, low cathode current, and two control electrodes. The control grid makes possible power cutoff with low negative grid voltage. Power output can be modulated with either the grid or anode, or both. Cathode modulation with the grid grounded usually reduces FM caused by AM. With all voltages isolated from both tube housing and the r.f. output terminal, packaging problems are simplified, since the tube housing and output connector can be grounded regardless of power supply configuration.

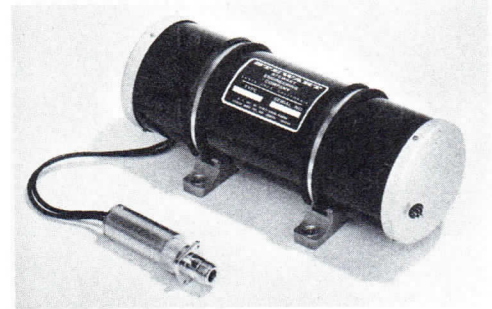

ELECTRICAL CHARACTERISTICS, CW	Typical Values	Absolute Ratings
Nominal Frequency Band, Gc	1.7-4.2	*
Power Output into a Load with VSWR=1.25, mW	50-150	30 Min.
Power Output Variation, db		8 Max.
Fine Grain Variation, db/250mc		3 Max.
Tube VSWR		2.5:1 Max.
Spurious Oscillation		
Ratio of Signal to 2nd Harmonic Output, db	30	20 Min.
Ratio of Signal to all other Spurious Output, db	55	45 Min.
Long-term sensitivity to Heater Voltage, Mc/V	2	8 Max.
Sensitivity to Anode Voltage, Mc/V	0.25	1.0 Max.
Sensitivity to Grid Voltage, Mc/V	3	6 Max.
Tuning Curve Slope, Mc/V		
Low End (1.7 Gc)	2.7	
Mid-Frequency (2.95 Gc)	1.4	
High End (4.2 Gc)	.75	
Grid r.f. Cutoff Voltage, V	-8	-20 Max.
Capacitance; Cathode to all other Electrodes, including Heater, uuf	18	25 Max.
Capacitance; Grid to all other Electrodes at Power Input Plug, uuf	18	25 Max.
Capacitance; Helix to all other Electrodes (12" Coax Cable attached), uuf	250	300 Max.

11/63

ELECTRICAL CHARACTERISTICS, CW (Contd.)

Heater Voltage, V
 Heater Current, A
 Heater-to-Cathode Leakage ($E_{hk} = \pm 90V$), μA
 Cathode Current, mA
 Helix Voltage Range, V
 Helix Current, mA
 Anode Voltage, V
 Anode Current, mA
 Anode Supply Impedance, Ohms

Typical Values	Absolute Ratings
0.9	$6.3 \pm 5\%$ 0.6-1.2 Min/Max. 25 Max.
8	15 Max.
235-2150	200-2250 Min/Max.
1	4 Max.
130	250 Max.
0.6	1.5 Max. 50K Max.

MECHANICAL DATA

Length, exclusive of Connectors, In. 10-3/4 Max.
 Height, In. 4-1/4 Max.
 Weight, Lbs. 12-1/2 Max.
 Output Cable Length (Type N Female Connector), In. 12 12 ± 1
 Power Input Connector Deutsch DM-5605-7P
 Forced Air Cooling, to + 60°C Ambient None required
 Mounting Position Any
 Separation from Passive Magnetic Materials, In. 2 Min.

SCHEMATIC DIAGRAM

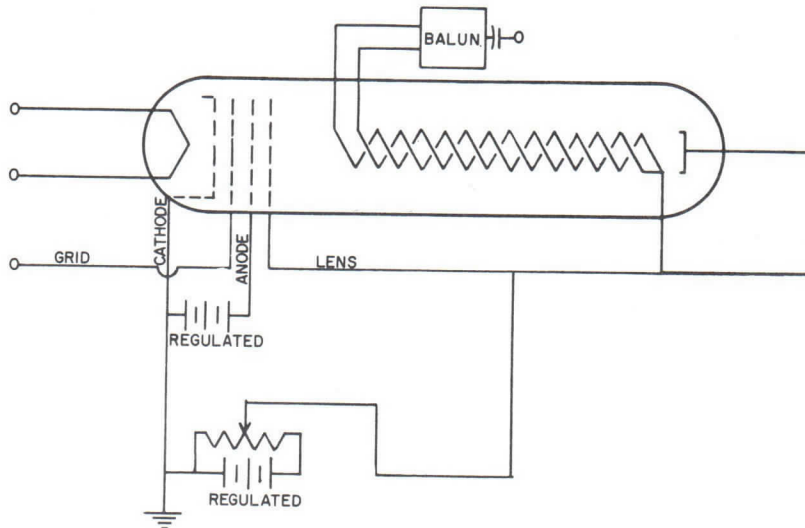

TUNING VOLTAGE

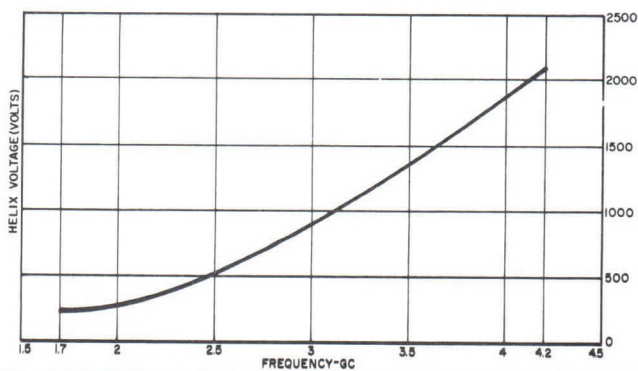

POWER OUTPUT

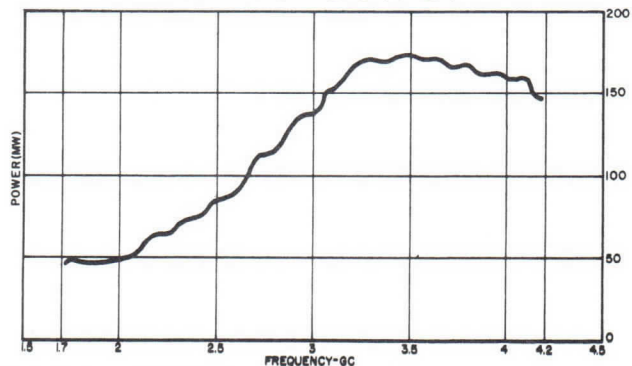

Vol. 1, No. 1; July, 1963

SE-205 and SE-205A

S-BAND BACKWARD-WAVE OSCILLATORS

The SE-205 and SE-205A are wide-band voltage-tunable oscillators operating in permanent-magnet focusing systems.

They offer significant advantages over the Stewart solenoid backward-wave oscillator, Type No. O.D. 2-4, in that the total weight is greatly reduced and the need for a solenoid power supply is completely eliminated. Further, the need for tube-to-magnet alignment by the customer is eliminated.

The many applications of these tubes include swept signal generators, radar receiver local oscillators, and signal sources for countermeasures systems.

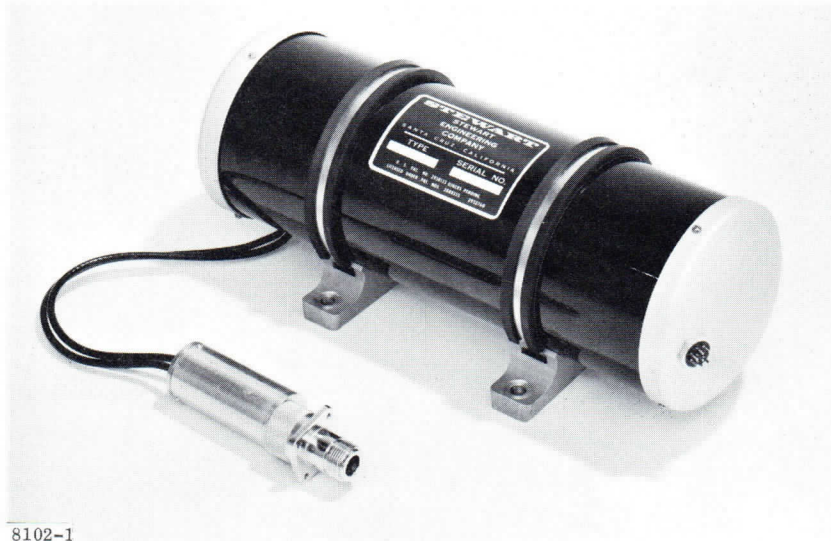

8102-1

Important among the operating advantages is the fact that all voltages are isolated from the tube housing and rf output connector. Also, because of the ability to use either or both of two cathode current control electrodes, output power can be manipulated with very low modulation voltage and essentially zero modulating power.

These Stewart tubes are designed to provide greatest possible bandwidth, efficiency, and uniform power output, and yet maintain the smallest possible physical dimensions. To achieve these goals, the tubes use a bifilar or double helix, each wire operating 180° out of phase with the other (push-pull). The power outputs of the two helices are added in a balun to provide a single-ended rf output and to suppress second harmonic components. The SE-205 and SE-205A operate in any physical position, require no external cooling, and do not have to be mounted on a heat sink. Electron beam configuration is closely controlled by precision gun-stacking assembly techniques¹ and by precision uniform-field magnets. Long life is achieved in part through low cathode loading (approximately 250 ma/cm²).

Further inquiries may be addressed to the Stewart Marketing Department or to our representative in your area.

¹ U. S. Patent No. 2,938,133

SPECIFICATION

SE-205 and SE-205A

PERMANENT-MAGNET O-TYPE BACKWARD-WAVE OSCILLATOR TUBES

	<u>SE-205</u>	<u>SE-205A</u>
<u>PERFORMANCE</u>		
Frequency	1.7-4.2 Gc	2.0-4.0 Gc
Power output	30 mw min.	50 mw min.
Power output variation	8 db max.	7 db max.
Tube VSWR	2.5:1 max.	2.5:1 max.
<u>ELECTRICAL REQUIREMENTS</u>		
Helix voltage	240-2130 v typ.	340-1860 v typ.
Anode voltage	160 v typ.	160 v typ.
Heater voltage	6.3 ±5% v	6.3 ±5% v
Heater current	0.6-1.2 a min./max.	0.6-1.2 a min./max.
Cathode current	15 ma max.	15 ma max.
<u>MECHANICAL</u>		
Over-all length	10 3/4 inches max.	10 3/4 inches max.
Weight	12 1/2 lb max.	12 1/2 lb max.
Output cable length	12 ± 1/2 inches	12 ± 1/2 inches
Output connector	N female	N female
Power input connector	Deutch DM-5605-7P	Deutch DM-5605-7P

STEWART ENGINEERING COMPANY
467 Bean Creek Road
Santa Cruz, California

Telephone: Area Code 408
426-4100

1 July 1963

BACKWARD-WAVE OSCILLATOR

The Type SE 205A BWO is a bifilar (dual helix), voltage tunable oscillator. This permanent-magnet focused wide band oscillator is well suited for use as a swept signal source in signal generators, particularly in view of its high stability. Other applications include radar receivers (as local oscillator), and ECM equipment. The SE 205A features smooth power over the band, low cathode current, and two control electrodes. The control grid makes possible power cutoff with low negative grid voltage. Power output can be modulated with either the grid or anode, or both. Cathode modulation with the grid grounded usually reduces FM caused by AM. With all voltages isolated from both tube housing and the r.f. output terminal, packaging problems are simplified, since the tube housing and output connector can be grounded regardless of power supply configuration.

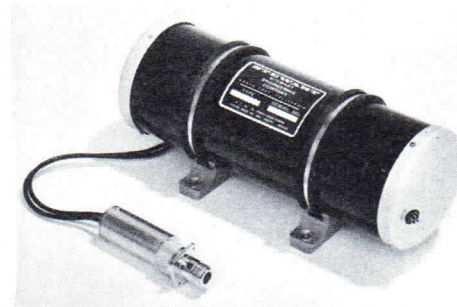

ELECTRICAL CHARACTERISTICS, CW	Typical Values	Absolute Ratings
Nominal Frequency Band, Gc	2-4	*
Power Output into a Load with VSWR=1.25, mW	50-150	50 Min.
Power Output Variation, db		6 Max.
Fine Grain Variation, db/250mc		3 Max.
Tube VSWR		2.5:1 Max.
Spurious Oscillation		
Ratio of Signal to 2nd Harmonic Output, db	30	20 Min.
Ratio of Signal to all other Spurious Output, db	55	45 Min.
Long-term sensitivity to Heater Voltage, Mc/V	2	8 Max.
Sensitivity to Anode Voltage, Mc/V	0.25	1.0 Max.
Sensitivity to Grid Voltage, Mc/V	3	6 Max.
Tuning Curve Slope, Mc/V		
Low End (2.0 Gc)	2.5	
Mid-Frequency (3.0 Gc)	1.4	
High End (4.0 Gc)	.85	
Grid r.f. Cutoff Voltage, V	-8	-20 Max.
Capacitance; Cathode to all other Electrodes, including Heater, uuf	18	25 Max.
Capacitance; Grid to all other Electrodes at Power Input Plug, uuf	18	25 Max.
Capacitance; Helix to all other Electrodes (12" Coax Cable Attached), uuf	250	300 Max.

11/63

* Selected tubes with extra power, extra bandwidth, lower power variation and other features are normally available on special order. These are design data only. For operating instructions refer to Stewart Instruction Sheet furnished with tube.

ELECTRICAL CHARACTERISTICS, CW (Contd.)

	Typical Values	Absolute Ratings
Heater V		6.3 ± 5%
Heater Current, A	0.9	0.6-1.2 Min/Max.
Heater-to-Cathode Leakage ($E_{hk} = \pm 90V$), μA		25 Max.
Cathode Current, mA	8	14 Max.
Helix Voltage Range, V	325-1850	300-2000 Min/Max.
Helix Current, mA	1	4 Max.
Anode Voltage, V	130	250 Max.
Anode Current, mA	0.6	1.5 Max.
Anode Supply Impedance, Ohms		50K Max.

MECHANICAL DATA

Length, exclusive of Connectors, In.	10-3/4 Max.
Height, In.	4-1/4 Max.
Weight, Lbs.	12-1/2 Max.
Output Cable Length (Type N Female Connector), In.	12
Power Input Connector	12 ± 1
Forced Air Cooling, to +60°C Ambient	Deutsch DM-5605-7P
Mounting position	None required
Separation from Passive Magnetic Materials, In.	Any
	2 Min.

SCHEMATIC DIAGRAM

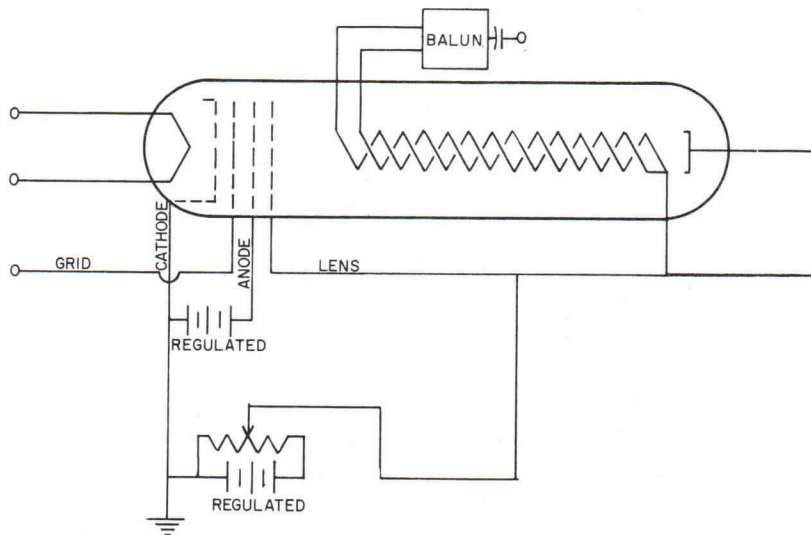

TUNING VOLTAGE

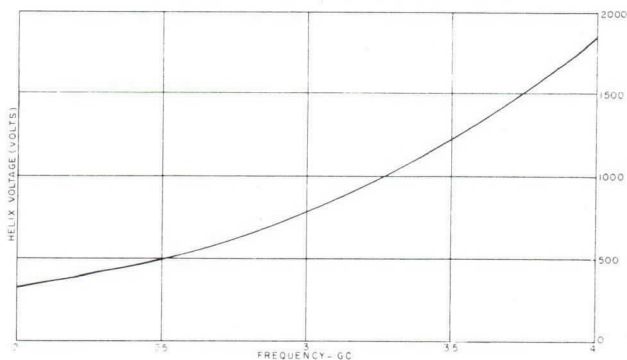

POWER OUTPUT

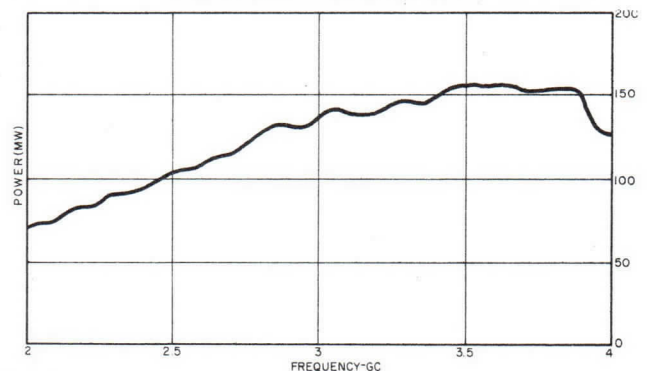

BACKWARD-WAVE OSCILLATOR

The Type SE 206 BWO is a bifilar (dual helix), voltage tunable oscillator. This permanent-magnet focused wide band oscillator is well suited for use as a swept signal source in signal generators, particularly in view of its high stability. Other applications include ECM receivers (as local oscillator), frequency diversity transmitters (as master oscillator), and other electronic equipment. The SE 206 features smooth power over the band, low cathode current, and two control electrodes. The control grid makes possible power cutoff with low negative grid voltage. Power output can be modulated with either the grid or anode, or both. Cathode modulation with the grid grounded usually reduces FM caused by AM. With all voltages isolated from both tube housing and the r.f. output terminal, packaging problems are simplified, since the tube housing and output connector can be grounded regardless of power supply configuration.

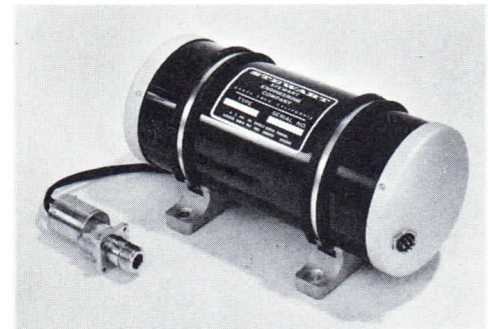

ELECTRICAL CHARACTERISTICS, CW

	Typical Values	Absolute Ratings
Nominal Frequency Band, Gc	3.7-8.3	*
Power Output into a Load with VSWR = 1.25, mW	25-100	10 Min.
Power Output Variation, db		8 Max.
Fine Grain Variation, db/250mc		3 Max.
Tube VSWR		2.5:1 Max.
Spurious Oscillation		
Ratio of Signal to 2nd Harmonic Output, db	35	20 Min.
Ratio of Signal to all other Spurious Output, db	60	45 Min.
Long-term sensitivity to Heater Voltage, Mc/V	4.0	7 Max.
Sensitivity to Anode Voltage, Mc/V	0.6	1 Max.
Sensitivity to Grid Voltage, Mc/V	3.0	5 Max.
Tuning Curve Slope, Mc/V		
Low End (3.7 Gc)	6.4	
Mid-Frequency (6.0 Gc)	2.7	
High End (8.3 Gc)	1.6	
Grid r.f. Cutoff Voltage, V	-7	-20 Max.
Capacitance; Cathode to all other Electrodes Including Heater, uuf	15	25 Max.
Capacitance; Grid to all other Electrodes, at Power Input Connector, uuf	10	15 Max.

10/63

* Selected tubes with extra power, extra bandwidth, lower power variation and other features are normally available on special order. These are design data only. For operating instructions refer to Stewart Instruction Sheet furnished with tube.

ELECTRICAL CHARACTERISTICS, CW (Contd.)

Typical Values

Absolute Ratings

Heater Voltage, V		6.3 ± 5%
Heater Current, A	0.9	0.6-1.2 Min/Max.
Heater-to-Cathode Leakage ($E_{hk} = \pm 90V$), μA		25 Max.
Cathode Current, mA	9.0	12 Max.
Helix Voltage Range, V	250-2000	200-2100 Min/Max
Helix Current, mA	1.5	3.0 Max.
Anode Voltage, V	150	250 Max.
Anode Current, mA	0.5	2.0 Max.
Anode Supply Impedance, Ohms		50K Max.

MECHANICAL DATA

Length, exclusive of Connectors, In.	9-3/8 Max.
Height, In.	4-1/4 Max.
Weight, Lbs.	10 Max.
Output Cable Length (Type N Connector), In.	12
Power Input Connector	Deutsch DM-5605-7P
Forced Air Cooling, to + 60°C Ambient	None required
Mounting Position	Any
Separation from Passive Magnetic Materials, In.	2 Min.

SCHEMATIC DIAGRAM

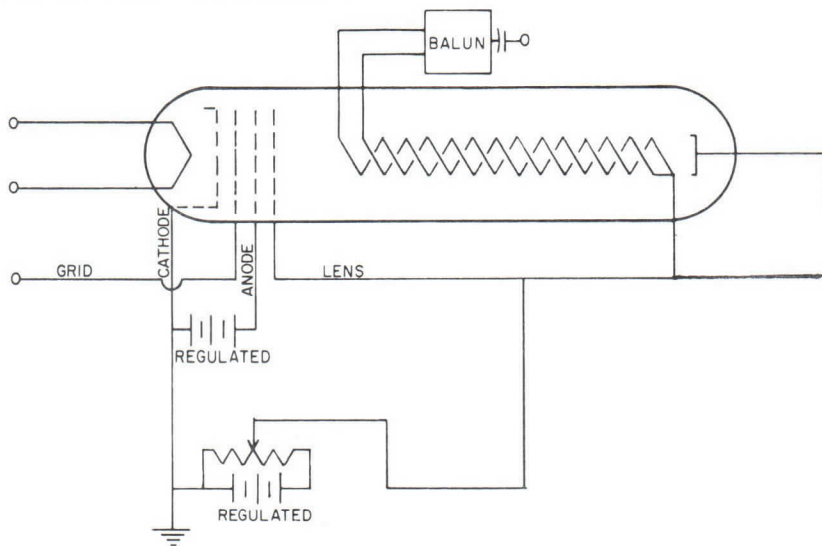

TUNING VOLTAGE

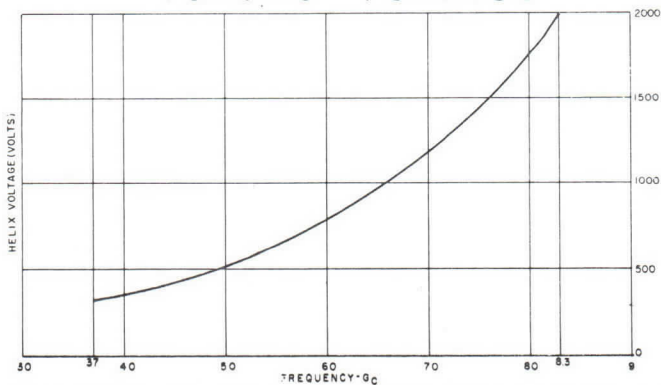

POWER OUTPUT

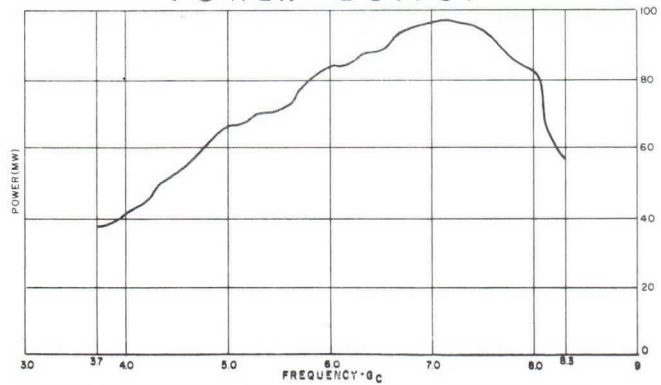

Vol. 1, No. 3; September, 1963

SE-206 and SE-206A

C-BAND BACKWARD-WAVE OSCILLATORS

The SE-206 and SE-206A are wide-band voltage-tunable "O" type oscillators which utilize integral permanent magnet focusing structures.

The many applications of these tubes include swept signal generators, local oscillators in radar receivers and in countermeasures systems, master oscillators in broadband transmitters and parametric amplifier pumps for frequency-agile radars.

All voltages are isolated from the tube housing and rf output connector. Either the grid or anode can be used for rf power leveling or modulation purposes with essentially zero modulating power required.

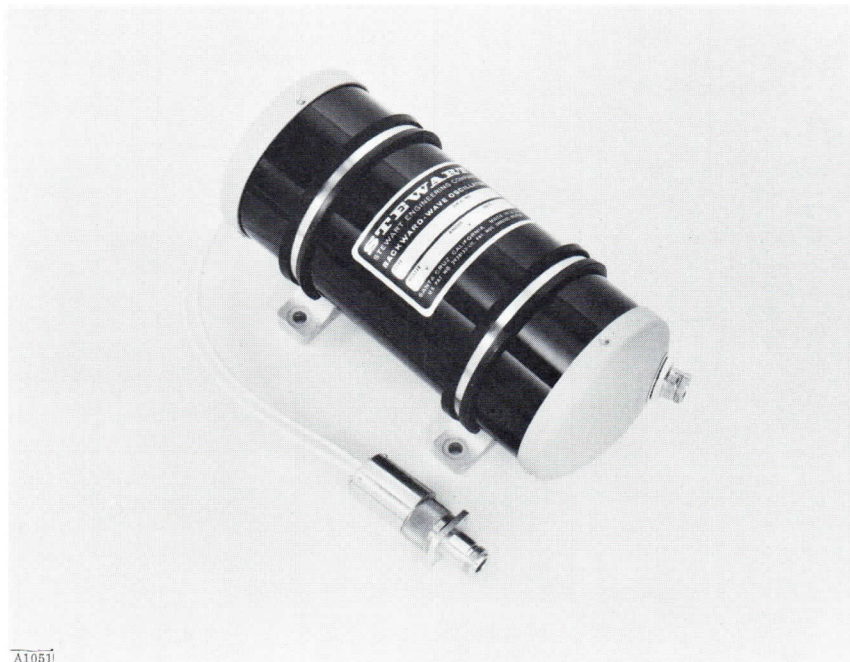

The SE-206 and SE-206A require no external cooling while operating at high ambient temperatures and do not have to be mounted on a heat sink. They may be mounted in any position without degrading their performance or adversely affecting operating life.

The Stewart tubes are designed to provide greatest possible bandwidth, efficiency, and uniform power output, and yet maintain the smallest possible physical dimensions.

To achieve these goals, the tubes use a bifilar or double helix, each helix operating 180° out of phase with the other (push-pull). The power outputs of the two helices are added in a balun to provide a single-ended rf output and to suppress second harmonic components.

Electron beam configuration is closely controlled by precision gun-stacking techniques¹ and by precision uniform-field magnets. Long life is achieved through careful processing and conservative cathode design (cathode loading is approximately 275 ma/cm²).

Further inquiries may be addressed to the Stewart Applications Engineering or to our representative in your area.

¹ U. S. Patent No. 2,938,133

SPECIFICATION

SE-206 and SE-206A

C-BAND BACKWARD-WAVE OSCILLATORS

<u>PERFORMANCE</u>	<u>SE-206</u>	<u>SE-206A</u>
Frequency	3.7-8.3 Gc	4.0-8.0 Gc
Power output	10 mw min.	20 mw min.
Power output variation	8 db max.	8 db max.
Tube VSWR	2.5:1 max.	2.5:1 max.
 <u>ELECTRICAL REQUIREMENTS</u>		
Helix voltage	250-2000 v typ.	310-1825 v typ.
Anode voltage	150 v typ.	150 v typ.
Heater voltage	6.3 ±5% v	6.3 ±5% v
Heater current	0.6-1.2 a min/max.	0.6-1.2 a min/max.
Cathode current	12 ma max.	12 ma max.
 <u>MECHANICAL</u>		
Over-all length	9-7/8 inches max.	9-7/8 inches max.
Weight	10 lbs. max.	10 lbs. max.
Output connector	N female	N female
Power input connector	Deutsch DM-5605-7P	Deutsch DM-5605-7P

STEWART ENGINEERING COMPANY
467 Bean Creek Road
Santa Cruz, California

Telephone: Area Code 408
426-4100

1 September 1963

BACKWARD-WAVE OSCILLATOR

The Type SE 206A BWO is a bifilar (dual helix), voltage tunable oscillator. This permanent-magnet focused wide band oscillator is well suited for use as a swept signal source in signal generators, particularly in view of its high stability. Other applications include ECM receivers (as local oscillator), frequency diversity transmitters (as master oscillator), and other electronic equipment. The SE 206A features smooth power over the band, low cathode current, and two control electrodes. The control grid makes possible power cutoff with low negative grid voltage. Power output can be modulated with either the grid or anode, or both. Cathode modulation with the grid grounded usually reduces FM caused by AM. With all voltages isolated from both tube housing and the r.f. output terminal, packaging problems are simplified, since the tube housing and output connector can be grounded regardless of power supply configuration.

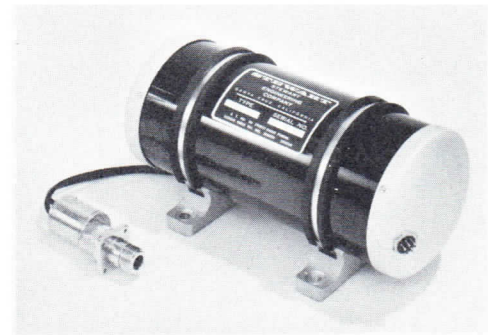

ELECTRICAL CHARACTERISTICS, CW

	Typical Values	Absolute Ratings
Nominal Frequency Band, Gc	4.0 - 8.0	*
Power Output into a Load with VSWR = 1.25, mW	35 - 100	20 Min.
Power Output Variation, db		6 Max.
Fine Grain Variation, db/250mc		3 Max.
Tube VSWR		2.5:1 Max.
Spurious Oscillation		
Ratio of Signal to 2nd Harmonic Output, db	35	20 Min.
Ratio of Signal to all other Spurious Output, db	60	45 Min.
Long-term sensitivity to Heater Voltage, Mc/V	5	10 Max.
Sensitivity to Anode Voltage, Mc/V	0.5	1 Max.
Sensitivity to Grid Voltage, Mc/V	3.0	5 Max.
Tuning Curve Slope, Mc/V		
Low End (4.0 Gc)	5.9	
Mid-Frequency (6.0 Gc)	2.7	
High End (8.0 Gc)	2.0	
Grid r.f. Cutoff Voltage, V	-7	-20 Max.
Capacitance; Cathode to all other Electrodes Including Heater, uuf	15	25 Max.
Capacitance; Grid to all other Electrodes, at Power Input Connector, uuf	10	15 Max.

11/63

ELECTRICAL CHARACTERISTICS, CW (Contd.)

Heater Voltage, V
 Heater Current, A
 Heater-to-Cathode Leakage ($E_{hk} = \pm 90V$), μA
 Cathode Current, mA
 Helix Voltage Range, V
 Helix Current, mA
 Anode Voltage, V
 Anode Current, mA
 Anode Supply Impedance, Ohms

Typical Values

Absolute Ratings

0.9	6.3 \pm 5%
9.0	0.6-1.2 Min/Max. 25 Max.
310-1825	12 Max. 250-1900 Min/Max
1.5	3.0 Max.
150	250 Max.
0.5	2.0 Max. 50K Max.

MECHANICAL DATA

Length, exclusive of Connectors, In.
 Height, In.
 Weight, Lbs.
 Output Cable Length (Type N Connector), In.
 Power Input Connector
 Forced Air Cooling, to + 60°C Ambient
 Mounting Position
 Separation from Magnetic Materials, In.

9-3/8 Max.
4-1/2 Max.
10-1/2 Max.
12
Deutsch DM-5605-7P
None required
Any
2 Min.

SCHEMATIC DIAGRAM

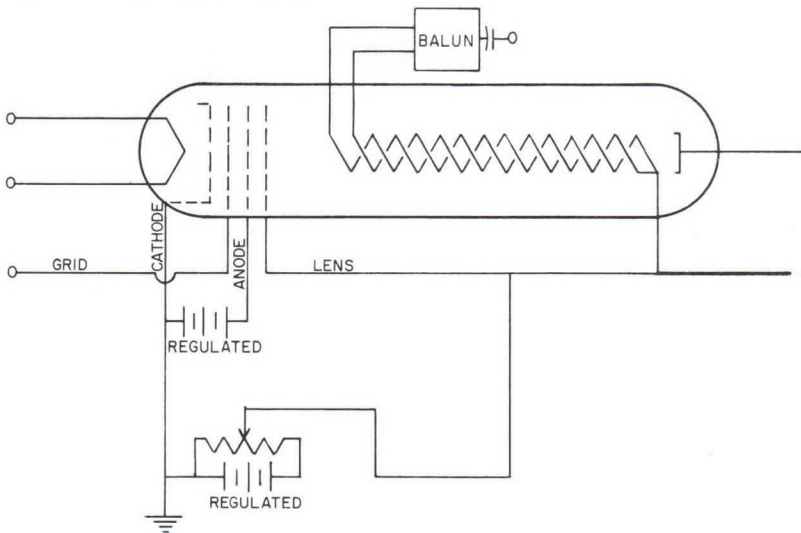

TUNING VOLTAGE

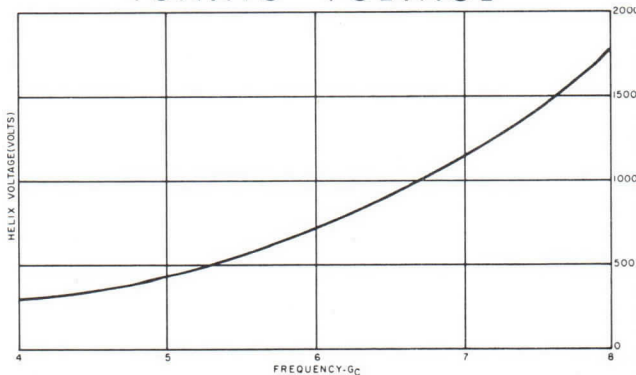

POWER OUTPUT

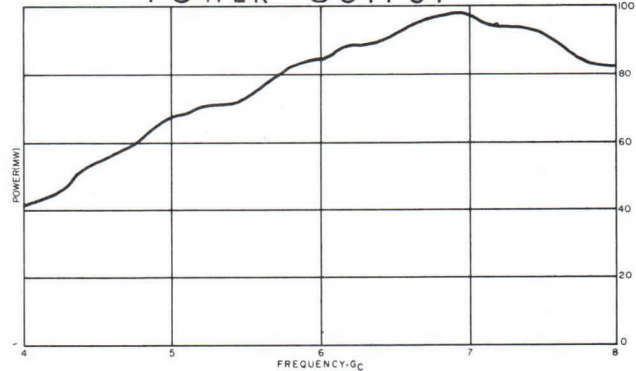

BACKWARD-WAVE OSCILLATOR

The Type SE 207 BWO is a single-helix, voltage tunable oscillator. This permanent-magnet focused wide band oscillator is well suited for use as a swept signal source in signal generators, particularly in view of its high stability. Other applications include ECM receivers (as local oscillator), frequency diversity transmitters (as master oscillator), and other electronic equipment. The SE 207 features smooth power over the band, low cathode current, and two control electrodes. The control grid makes possible power cutoff with low negative grid voltage. Power output can be modulated with either the grid or anode, or both. Cathode modulation with the grid grounded usually reduces FM caused by AM. With all voltages isolated from both tube housing and the r.f. output terminal, packaging problems are simplified, since the tube housing and output connector can be grounded regardless of power supply configuration.

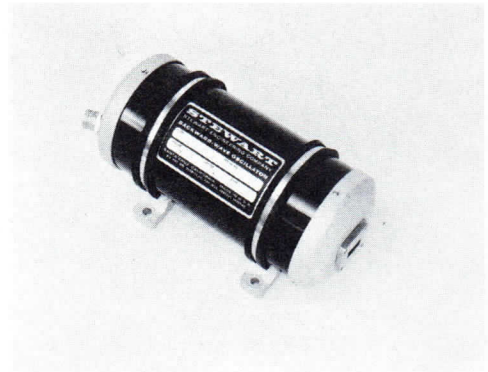

ELECTRICAL CHARACTERISTICS, CW	Typical Values	Absolute Ratings
Nominal Frequency Band, Gc	12.4-18	*
Power Output into Load VSWR=1.25, mW	25-70	20 Min.
Power Output Variation, db		6 Max.
Fine Grain Variation, db/250 mc		3 Max.
Tube VSWR		2.5:1 Max.
Ratio of Signal to Total Supurious Output, db	48	40 Min.
Long-term sensitivity to Heater Voltage, Mc/V	5	10 Max.
Sensitivity to Anode Voltage, Mc/V	0.5	1.5 Max.
Sensitivity to Grid Voltage, Mc/V	3	6 Max.
Tuning Curve Slope, Mc/V		
Low End (12.4 Gc)	8.7	
Mid-Frequency (15.2 Gc)	4.4	
High End (18.0 Gc)	2.2	
Grid r.f. Cutoff Voltage, V	-15	-20 Max.
Capacitance; Cathode to all other Electrodes Incl. Heater, uuf	25	40 Max.
Capacitance; Grid to all other Electrodes, at Power Input Connector, uuf	25	40 Max.
Capacitance; Helix to all other Electrodes and Capsule (9" Coax Cable Attached), uuf	100	125 Max.

10/63

ELECTRICAL CHARACTERISTICS, CW (Contd.)

Typical
Values

Absolute
Ratings

Heater Voltage, V		6.3 ± 5%
Heater Current, A	0.9	0.6-1.2 Min./Max.
Heater-to-Cathode Leakage ($E_{hk} = -90$ V), μ A		25 Max.
Cathode Current, mA	7	12 Max.
Helix Voltage Range, V	530-1900	500-2000 Min./Max.
Helix Current, mA	2	3 Max.
Anode Voltage, V	200	250 Max.
Anode Current, mA	1.0	2 Max.
Anode Supply Impedance, Ohms		50K Max.

MECHANICAL DATA

Length, exclusive of Connectors, In.	9-1/4 Max.
Height, In.	4-1/4 Max.
Weight, lbs.	11 Max.
R.F. Output Connector	UG 419/U Flange
Power Input Connector	Deutsch DM-5605-7P
Forced Air Cooling, to +60°C Ambient	None required
Mounting Position	Any
Separation from Passive Magnetic Materials, In.	2 Min.

SCHEMATIC DIAGRAM

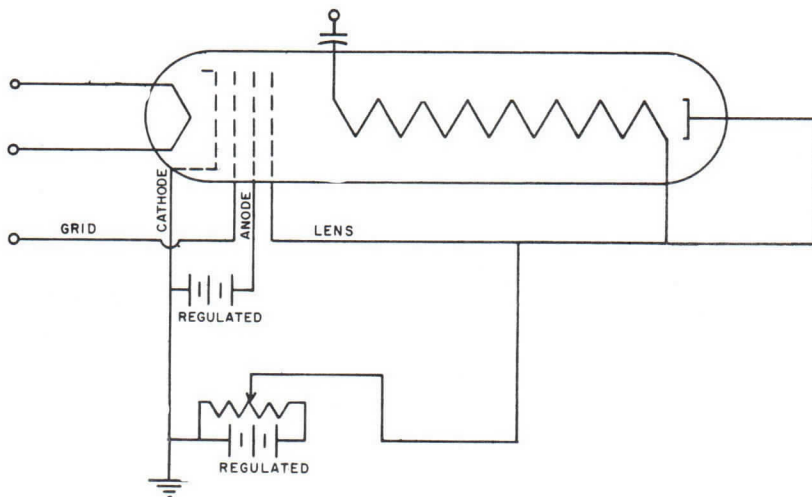

TUNING VOLTAGE

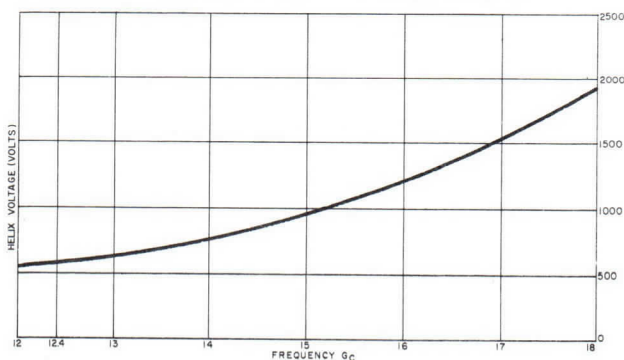

POWER OUTPUT

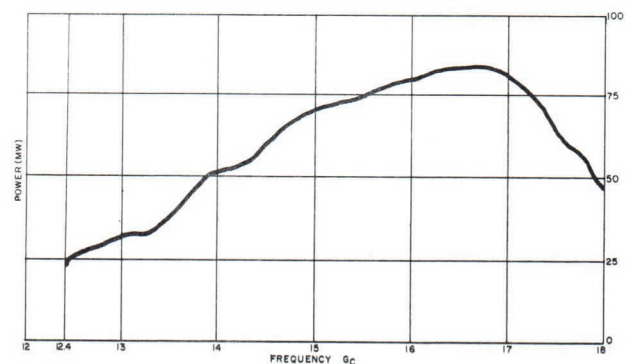

Vol. 2, No. 1; January, 1964

SE-209 and SE-209A

X-BAND BACKWARD-WAVE OSCILLATORS

The SE-209 and SE-209A are new medium-weight backward-wave oscillators designed primarily for use in sweep oscillators and related test equipment. They also can be used as local oscillators in radar receivers and in countermeasures systems, master oscillators, and parametric amplifier pumps. The straight line package of square cross-section is provided for ease of handling and positioning in or out of equipment. The oscillators are secured in the instrument by using internal mounting nuts. Thus, a sizable smooth external surface is provided for good thermal conduction. Internal heat is transferred effectively to the housing through highly conductive epoxies.

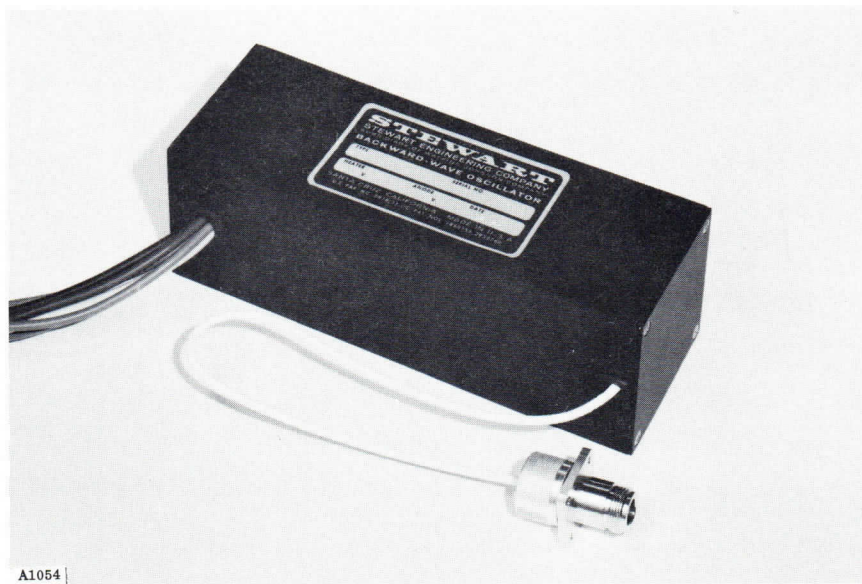

A1054

The Alnico magnet is stabilized during the charging process to ensure long uniform magnet life, as well as better resistance to environmental changes. The field straightener serves to minimize tube sensitivity to external fields.

All tube electrodes are dc isolated from both the Type "N" connector output and the housing. The connector is supplied on a flying coaxial cable, thus eliminating the need for the customer to add elbows or short coaxial lines with accompanying degradation in performance. Both the SE-209 and SE-209A are provided with a Type "N" female output connector. The narrower-band version is available with a coax to waveguide adapter as the SE-209D.

The delay line used is a monofilar helix. The helix setting and tightening techniques developed for the construction of these tubes have been used on over 8,000 backward-wave oscillators. The cold VSWR looking into the tube is normally better than 2:1, which provides for smooth power output curves with excellent fine-grain power variation. The tubes will operate successfully into loads with VSWR up to 5:1.

Delay line voltages are chosen consistent with good design for best over-all efficiency and minimal modulation sensitivity. The total beam input power is usually less than 12 watts with a beam current of 6 ma.

The weight of these tubes is less than 6 pounds and volume is 47 in³. This should permit design of much lighter weight and smaller X-band test equipment than was heretofore possible.

Further inquiries may be addressed to Stewart Applications Engineering or to our representative in your area.

SPECIFICATION

SE-209 and SE-209A

X-BAND BACKWARD-WAVE OSCILLATORS

	<u>SE-209</u>	<u>SE-209A</u>
<u>PERFORMANCE</u>		
Frequency	7-12.4 Gc	8.2-12.4 Gc
Power output	10 mw min.	20 mw min.
Power output variation	10 db max.	6 db max.
Tube VSWR	2.5:1 max.	2.5:1 max.
<u>ELECTRICAL REQUIREMENTS</u>		
Helix voltage	310-2000 v typ.	500-2000 v typ.
Anode voltage	160 v typ.	160 v typ.
Heater voltage	6.3 ± 5% v	6.3 ± 5% v
Heater current	0.6-1.2 a min./max.	0.6-1.2 a min./max.
Cathode current	12 ma max.	12 ma max.
<u>MECHANICAL</u>		
Over-all length	7 3/4 inches max.	7 3/4 inches max.
Weight	6 lb. max.	6 lb. max.
Output cable length	12 ± 1/2 inches	12 ± 1/2 inches
Output connector	N female	N female
Power input connector	Flying leads	Flying leads

STEWART ENGINEERING COMPANY
Subsidiary of Watkins-Johnson Company
467 Bean Creek Road
Santa Cruz, California

Telephone: Area Code 408 - 426-4100
Teletype: Area Code 408 - 423-7545

1 January 1964

SPECIFICATION

SE-209 and SE-209A

X-BAND BACKWARD-WAVE OSCILLATORS

<u>PERFORMANCE</u>	<u>SE-209</u>	<u>SE-209A</u>
Frequency	7-12.4 Gc	8.2-12.4 Gc
Power output	10 mw min.	20 mw min.
Power output variation	10 db max.	6 db max.
Tube VSWR	2.5:1 max.	2.5:1 max.
 <u>ELECTRICAL REQUIREMENTS</u>		
Helix voltage	310-2000 v typ.	500-2000 v typ.
Anode voltage	160 v typ.	160 v typ.
Heater voltage	6.3 ± 5% v	6.3 ± 5% v
Heater current	0.6-1.2 a min./max.	0.6-1.2 a min./max.
Cathode current	12 ma max.	12 ma max.
 <u>MECHANICAL</u>		
Over-all length	7 3/4 inches max.	7 3/4 inches max.
Weight	6 lb. max.	6 lb. max.
Output cable length	12 ± 1/2 inches	12 ± 1/2 inches
Output connector	N female	N female
Power input connector	Flying leads	Flying leads

STEWART ENGINEERING COMPANY
Subsidiary of Watkins-Johnson Company
467 Bean Creek Road
Santa Cruz, California

Telephone: Area Code 408 - 426-4100
Teletype: Area Code 408 - 423-7545

1 January 1964

BACKWARD-WAVE OSCILLATOR

The Type SE 209 BWO is a single-helix, voltage tunable oscillator. This permanent-magnet-focused wide band oscillator is well suited for use as a swept signal source in signal generators, particularly in view of its high stability. Other applications include radar receivers (as local oscillator), frequency diversity transmitters (as master oscillator), and ECM equipment. The SE 209 features smooth power over the band, low cathode current, and two control electrodes. The control grid makes possible power cutoff with low negative grid voltage. Power output can be modulated with either the grid or anode, or both. Cathode modulation with the grid grounded usually reduces FM caused by AM. With all voltages isolated from both tube housing and the r.f. output terminal, packaging problems are simplified, since the tube housing and output connector can be grounded regardless of power supply configuration.

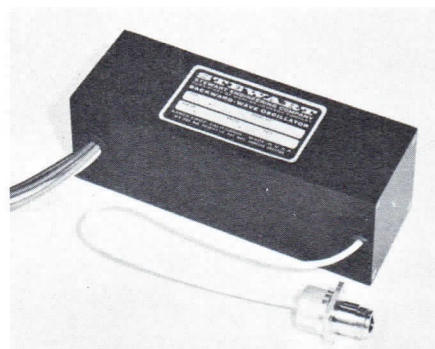

ELECTRICAL CHARACTERISTICS, CW

	Typical Values	Absolute Ratings
Nominal Frequency Band, Gc	7.0-12.4	*
Power Output (Load VSWR=1.25), mW	12-80	10 Min.
Power Output Variation, db		10 Max.
Fine Grain Variation, db/250mc		3 Max.
Tube VSWR		2.5:1 Max.
Ratio of Signal to Total Spurious Output, db	60	45 Min.
Long-term Sensitivity to Heater Voltage, Mc/V	7.5	10 Max.
Sensitivity to Anode Voltage, Mc/V	0.5	1:0 Max.
Sensitivity to Grid Voltage, Mc/V	2	4 Max.
Tuning Curve Slope, Mc/V		
Low End (7.0 Gc)	8.5	
Mid-Frequency (9.7 Gc)	3.9	
High End (12.4 Gc)	1.5	
Grid r.f. Cutoff Voltage, V	-10	-20 Max.
Capacitance; Cathode to all other Electrodes incl. Heater, uuf	28	35 Max.
Capacitance; Grid to all other Electrodes, at power input connector, uuf	28	35 Max.
Capacitance; r.f. connector center pin and housing to all other electrodes, uuf	135	150 Max.

11/63

* Selected tubes with extra power, extra bandwidth, lower power variation and other features are normally available on special order. These are design data only. For operating instructions refer to Stewart Instruction Sheet furnished with tube.

ELECTRICAL CHARACTERISTICS, CW (Contd.)

	Typical Values	Absolute Ratings
Heater Voltage, V		6.3 ± 5%
Heater Current, A	0.9	0.6 - 1.2 Min/Max
Heater-to-Cathode Leakage ($E_{hk} = -90V$), μA		25 Max.
Cathode Current	9	12 Max.
Helix Voltage Range, V	310-2000	250 - 2100 Min/Max
Helix Current, mA	1.5	3 Max.
Anode Voltage, V	160	250 Max.
Anode Current, mA	1	2 Max.
Anode Supply Impedance		50K Max.

MECHANICAL DATA

Length, exclusive of connectors, In.	7-3/4 Max.
Height and Depth, In.	2-1/2
Weight, Lbs.	6 Max.
R.f. Output Connector	Type N Female
Power Input	Flying Leads
Forced Air Cooling, to + 60°C Ambient	None Required
Mounting Position	Any
Separation from Passive Magnetic Materials, In.	2 Min.

SCHEMATIC DIAGRAM

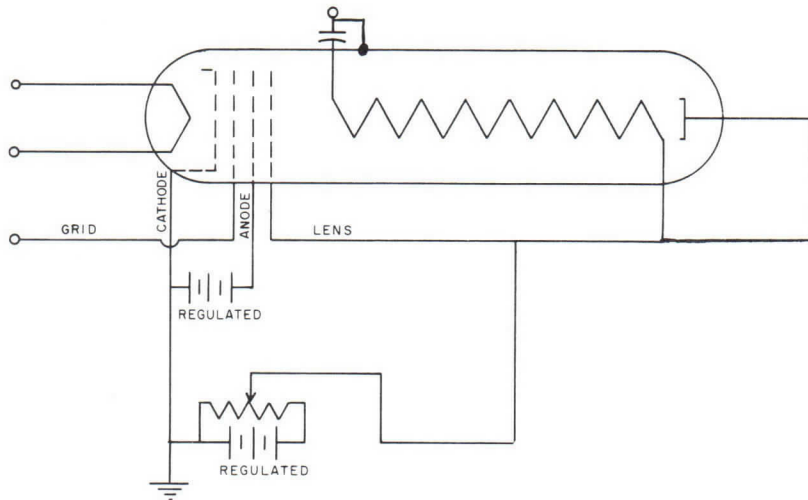

TUNING VOLTAGE

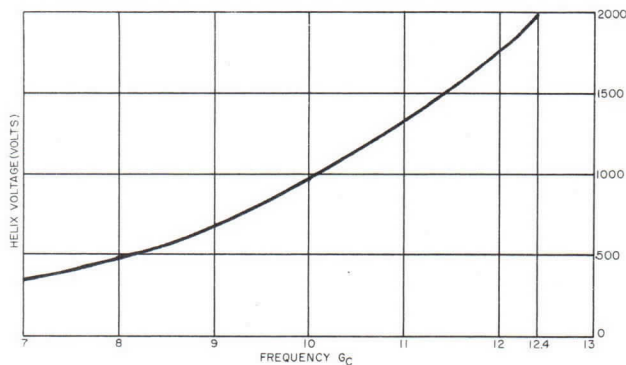

POWER OUTPUT

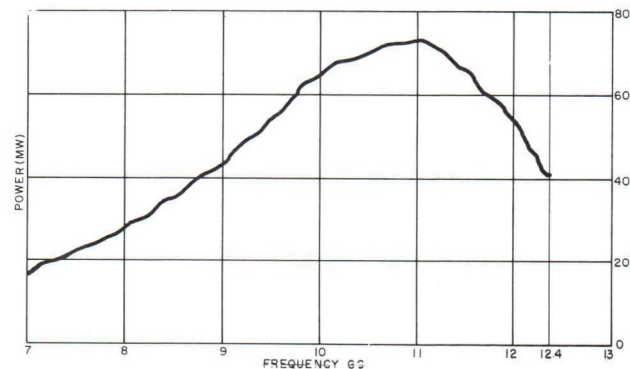

BACKWARD-WAVE OSCILLATOR

The Type SE 209 A BWO is a single-helix, voltage tunable oscillator. This permanent-magnet-focused wide band oscillator is well suited for use as a swept signal source in signal generators, particularly in view of its high stability. Other applications include radar receivers (as local oscillator), frequency diversity transmitters (as master oscillator), and ECM equipment. The SE 209 A features smooth power over the band, low cathode current, and two control electrodes. The control grid makes possible power cutoff with low negative grid voltage. Power output can be modulated with either the grid or anode, or both. Cathode modulation with the grid grounded usually reduces FM caused by AM. With all voltages isolated from both tube housing and the r.f. output terminal, packaging problems are simplified, since the tube housing and output connector can be grounded regardless of power supply configuration.

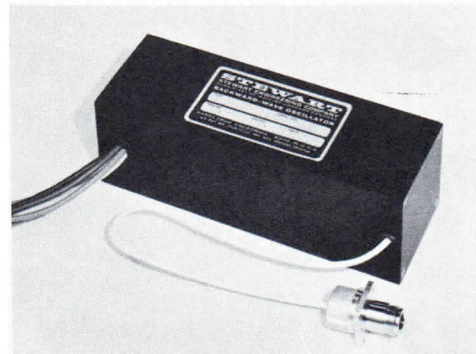

ELECTRICAL CHARACTERISTICS, CW	Typical Values	Absolute Ratings
Nominal Frequency Band, Gc	8.2-12.4	*
Power Output into Load with VSWR=1.25, mW	25-50	20 Min.
Power Output Variation, db		6 Max.
Fine Grain Variation, db/250 mc		3 Max.
Tube VSWR		2.5:1 Max.
Ratio of Signal to Total Spurious Output, db	60	45 Min.
Long-term Sensitivity to Heater Voltage, Mc/V	7.5	10 Max.
Sensitivity to Anode Voltage, Mc/V	0.5	1.0 Max.
Sensitivity to Grid Voltage, Mc/V	2	4 Max.
Tuning Curve Slope, Mc/V		
Low End (8.2 Gc)	7.0	
Mid-Frequency (10.3 Gc)	3.5	
High End (12.4 Gc)	1.5	
Grid r.f. Cutoff Voltage, V	-10	-20 Max.
Capacitance; Cathode to all other Electrodes inc. Heater, uuf	28	35 Max.
Capacitance; Grid to all other Electrodes, at Power Input Connector, uuf	28	35 Max.
Capacitance; r.f. connector center pin and Housing to all other Electrodes, uuf	135	150 Max.

11/63

* Selected tubes with extra power, extra bandwidth, lower power variation and other features are normally available on special order. These are design data only. For operating instructions refer to Stewart Instruction Sheet furnished with tube.

ELECTRICAL CHARACTERISTICS, CW (Contd.)

	Typical Values	Absolute Ratings
Heater Voltage, V		6.3 ± 5%
Heater Current, A	0.9	0.6-1.2 Min/Max.
Heater-to-Cathode Leakage ($E_{hk} = -90V$), μA		25 Max.
Cathode Current, mA	8	12 Max.
Helix Voltage Range, V	500-2000	450-2100 Min/Max.
Helix Current, mA	1.5	3 Max.
Anode Voltage, V	150	250 Max.
Anode Current, mA	0.5	2 Max.
Anode Supply Impedance, Ohms		50K Max.

MECHANICAL DATA

Length, exclusive of connectors, In.	7-3/4 Max.
Height and Depth, In.	2-1/2
Weight, Lbs.	6 Max.
R.F. Output Connector	Type N Female
Power Input	Flying Leads
Forced Air Cooling, to + 60°C Ambient	None Required
Mounting Position	Any
Separation from Passive Magnetic Materials, In.	2 Min.

SCHEMATIC DIAGRAM

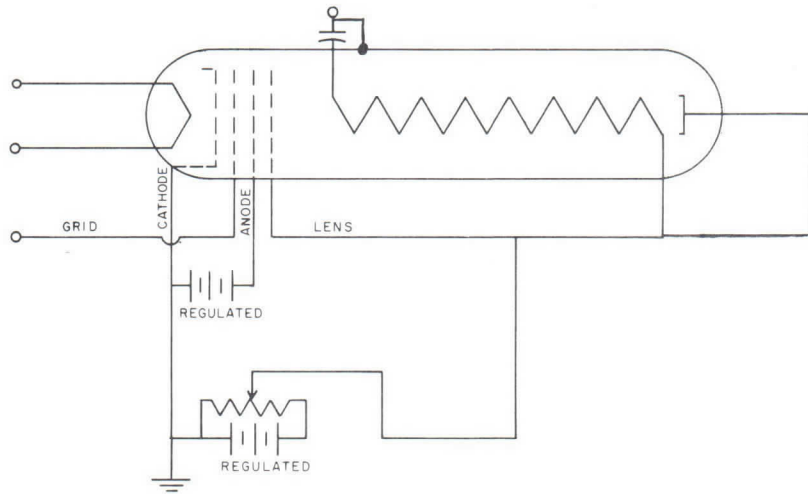

TUNING VOLTAGE

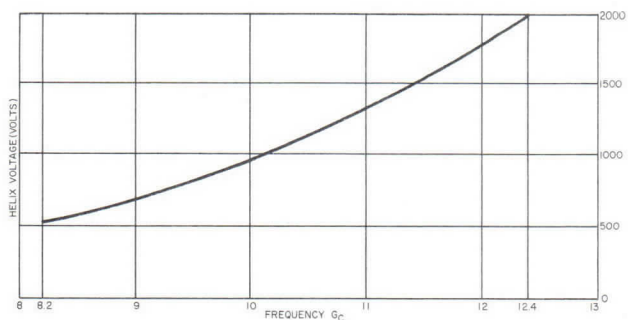

POWER OUTPUT

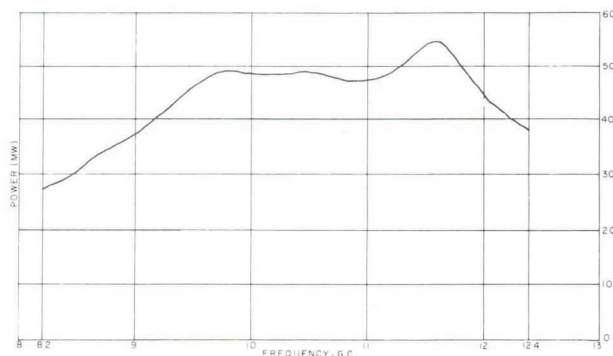

Vol. 2, No. 2; February, 1964

SE-211A and SE-211B

C-BAND BACKWARD-WAVE OSCILLATORS

The SE-211A and SE-211B represent new packaging of Stewart's C-band backward-wave oscillators to facilitate easier handling and provide more flexibility in mounting the tubes within instruments and equipments. In addition, the repackaging has resulted in approximately halving both weight and volume requirements.

These oscillators are used primarily in swept signal generators and portable test equipment; however, they are used as local oscillators in radar and countermeasures systems, master oscillators in transmitting systems and as parametric amplifier and maser pumps.



A1060

Mounting is accomplished by four internal self-clinching nuts, which are spaced equally on all Stewart tubes of this series to provide ready interchangeability.

The slow-wave structure is a bifilar helix, precision wound to very close tolerances. The electron beam is hollow for best rf efficiency and minimum collector dissipation. Cathode loading of 250 ma/cm^2 is quite conservative and leads to long tube life, typically well over 5000 hours.

A highly uniform focusing field is provided by a stabilized Alnico magnet and a precision stacked field straightener. The field straightener also effectively reduces the tube's sensitivity to external magnetic disturbances.

All electrodes are dc isolated from both the "N" connector output and the housing. The type "N" female connector is supplied on a coaxial cable, thus eliminating need for customer to add elbows or short coaxial lines with accompanying degradation in performance. Power input is provided by means of color-coded flying leads for connection to terminal strips or a connector.

With weight of less than 6 pounds, volume of 47 cubic inches, and power consumption of only 12 watts, much lighter-weight C-band equipment can be designed around this tube.

Further inquiries may be addressed to Stewart Applications Engineering or to our representative in your area.

SPECIFICATION

SE-211A and SE-211B

C-BAND BACKWARD-WAVE OSCILLATORS

	<u>SE-211A</u>	<u>SE-211B</u>
<u>PERFORMANCE</u>		
Frequency	4.0-8.0 Gc	3.7-8.3 Gc
Power output	20 mw min.	10 mw min.
Power output variation	6 db max.	8 db max.
Tube VSWR	2.5:1 max.	2.5:1 max.
<u>ELECTRICAL REQUIREMENTS</u>		
Helix voltage	310-1825 v typ.	250-2000 v typ.
Anode voltage	150 v typ.	150 v typ.
Heater voltage	6.3 ± 5% v	6.3 ± 5% v
Heater current	0.6-1.2 a min./max.	0.6-1.2 a min./max.
Cathode current	12 ma max.	12 ma max.
<u>MECHANICAL</u>		
Overall	7-3/4 inches max.	7-3/4 inches max.
Height and depth	2-1/2 inches	2-1/2 inches
Weight	6 pounds max.	6 pounds max.
Output connector	N female	N female
Power input connector	Flying leads	Flying leads

STEWART ENGINEERING COMPANY
Subsidiary of Watkins-Johnson Company
467 Bean Creek Road
Santa Cruz, California

Telephone: Area Code 408 - 426-4100
Teletype: Area Code 408 - 423-7545

1 February 1964

BACKWARD-WAVE OSCILLATOR

The Type SE 211A BWO is a bifilar (dual helix), voltage tunable oscillator. This permanent-magnet focused wide band oscillator is well suited for use as a swept signal source in signal generators, particularly in view of its high stability. Other applications include ECM receivers (as local oscillator), frequency diversity transmitters (as master oscillator), and other electronic equipment. The SE 211A features smooth power over the band, low cathode current, and two control electrodes. The control grid makes possible power cutoff with low negative grid voltage. Power output can be modulated with either the grid or anode, or both. Cathode modulation with the grid grounded usually reduces FM caused by AM. With all voltages isolated from both tube housing and the r.f. output terminal, packaging problems are simplified, since the tube housing and output connector can be grounded regardless of power supply configuration.

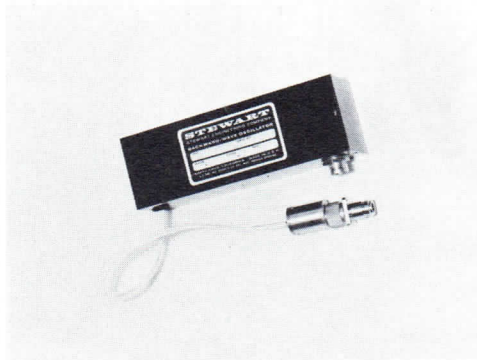

ELECTRICAL CHARACTERISTICS, CW

	Typical Values	Absolute Ratings
Nominal Frequency Band, Gc	4.0 - 8.0	*
Power Output into a Load with VSWR = 1.25, mW	30 - 70	20 Min.
Power Output Variation, db		6 Max.
Fine Grain Variation, db/250 mc		3 Max.
Tube VSWR		2.5:1 Max.
Spurious Oscillation		
Ratio of Signal to 2nd Harmonic Output, db	35	20 Min.
Ratio of Signal to all other Spurios Output, db	60	45 Min.
Long-term sensitivity to Heater Voltage, Mc/V	5	10 Max.
Sensitivity to Anode Voltage, Mc/V	0.5	1 Max.
Sensitivity to Grid Voltage, Mc/V	3.0	5 Max.
Tuning Curve Slope, Mc/V		
Low Eng (4.0 Gc)	5.9	
Mid-Frequency (6.0 Gc)	2.7	
High End (8.0 Gc)	2.0	
Grid r.f. Cutoff Voltage, V	-7	-20 Max.
Capacitance; Cathode to all other Electrodes Including Heater, uuf	30	45 Max.
Capacitance; Grid to all other Electrodes, at Power Input Connector, uuf	30	45 Max.

ELECTRICAL CHARACTERISTICS, CW (Contd.)

	Typical Values	Absolute Ratings
Heater Voltage, V		$6.3 \pm 5\%$
Heater Current, A	0.9	0.6-1.2 Min/Max.
Heater-to-Cathode Leakage ($E_{hk} = \pm 90$ V), μ A		25 Max.
Cathode Current, mA	9.0	12 Max.
Helix Voltage Range, V	310-1825	250-1900 Min/Max.
Helix Current, mA	1.5	3.0 Max.
Anode Voltage, V	150	250 Max.
Anode Current, mA	0.5	2.0 Max.
Anode Supply Impedance, Ohms		50K Max.

MECHANICAL DATA

Length, exclusive of Connectors, In.	7-1/2 Max.
Height and Depth, In.	2-1/2 Max.
Weight, Lbs.	6 Max.
Output Cable Length (Type N Connector), In.	12
Power Input Connector	Deutsch DM-5605-7P
Forced Air Cooling, to + 60°C Ambient	None required
Mounting Position	Any
Separation from Magnetic Materials, In.	2 Min.

SCHEMATIC DIAGRAM

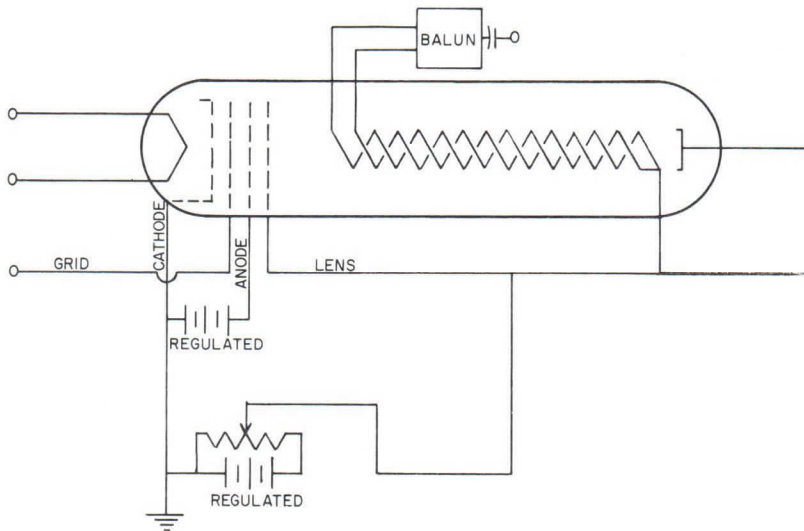

TUNING VOLTAGE

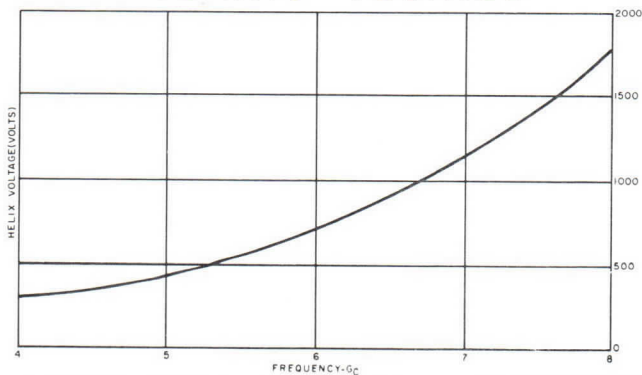

POWER OUTPUT

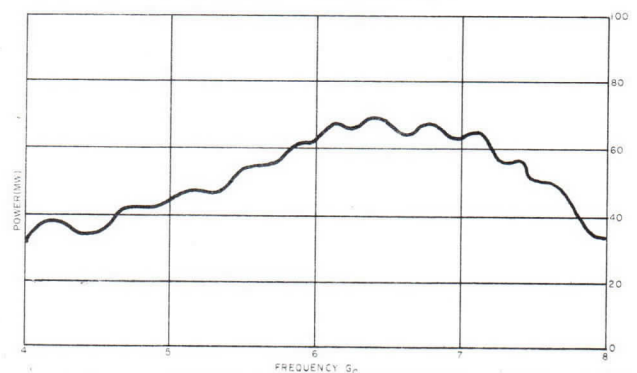

BACKWARD-WAVE OSCILLATOR

The Type SE 214A BWO is a bifilar (dual helix), voltage tunable oscillator. This permanent-magnet focused wide band oscillator is well suited for use as a swept signal source in signal generators, particularly in view of its high stability. Other applications include ECM receivers (as local oscillator), frequency diversity transmitters (as master oscillator), and other electronic equipment. The SE 214A features smooth power over the band, low cathode current, and two control electrodes. The control grid makes possible power cutoff with low negative grid voltage. Power output can be modulated with either the grid or anode, or both. Cathode modulation with the grid grounded usually reduces FM caused by AM. With all voltages isolated from both tube housing and the r.f. output terminal, packaging problems are simplified, since the tube housing and output connector can be grounded regardless of power supply configuration.

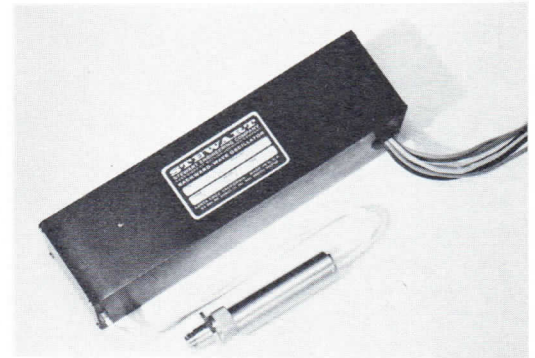

ELECTRICAL CHARACTERISTICS, CW

	Typical Values	Absolute Ratings
Nominal Frequency Band, Gc	1.0-2.0	*
Power Output into Load VSWR = 1.25, mW	110-450	100 Min.
Power Output Variation, db		8 Max.
Fine Grain Variation, db/50mc		3 Max.
Tube VSWR		2.5:1 Max.
Spurious Oscillation		
Ratio of Signal to 2nd Harmonic Output, db	35	20 Min.
Ratio of Signal to all other Spurious Output, db	60	45 Min.
Long-term sensitivity to Heater Voltage, Mc/V	4	8 Max.
Sensitivity to Anode Voltage, Mc/V	0.3	0.7 Max.
Sensitivity to Grid Voltage, Mc/V	1.5	5 Max.
Tuning Curve Slope, Mc/V		
Low End (1.0 Gc)	1.4	
Mid-Frequency (1.5 Gc)	.9	
High End (2.0 Gc)	.7	
Grid r.f. Cutoff Voltage, V	-7	-20 Max.
Capacitance; Cathode to all other Electrodes including Heater, uuf	15	25 Max.
Capacitance; Grid to all other Electrodes, at Power input plug, uuf	20	25 Max.
Capacitance; Helix to all other Electrodes (12" Coax Cable Attached), uuf	250	300 Max.

11/63

* Selected tubes with extra power, extra bandwidth, lower power variation and other features are normally available on special order. These are design data only. For operating instructions refer to Stewart Instruction Sheet furnished with tube.

ELECTRICAL CHARACTERISTICS, CW (Contd.)

	Typical Values	Absolute Ratings
Heater Voltage, V		6.3 ± 5%
Heater Current, A	0.85	1.2 Max.
Heater-to-Cathode Leakage ($E_{hk} = \pm 90V$), μA		25 Max.
Cathode Current, mA	12	17 Max.
Helix Voltage Range, V	335-1450	310-1485 Min/Max.
Helix Current, mA	1.5	4.0 Max.
Anode Voltage, V	150	250 Max.
Anode Current, mA	0.8	1.5 Max.
Anode Supply Impedance, Ohms		50K Max.

MECHANICAL DATA

Length, exclusive of Connectors, In.	10-7/8 Max.
Height and Depth, In.	3-1/64 Max.
Weight, Lbs.	12.5 Max.
Output Cable Length (Type N Connector), In.	12
Power Input	Flying Leads
Forced Air Cooling, to + 60°C Ambient	None required
Mounting Position	Any
Separation from Magnetic Materials, In.	2 Min.

SCHEMATIC DIAGRAM

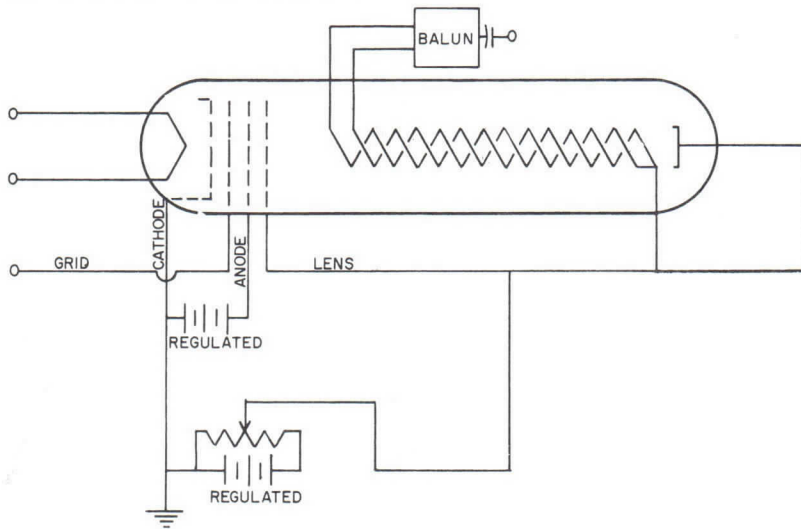

TUNING VOLTAGE

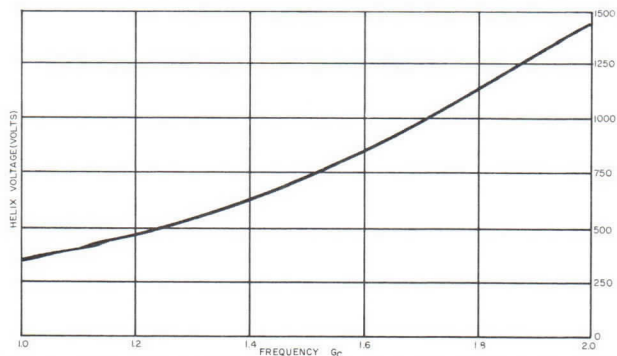

POWER OUTPUT

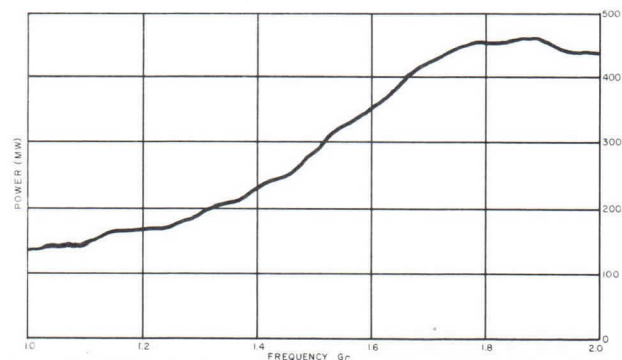

Vol. 1, No. 6; December, 1963

SE-214A

L-BAND BACKWARD-WAVE OSCILLATOR

The SE-214A is a wide-band voltage-tunable "O" type oscillator which utilizes an integral permanent magnet focusing structure.

The many applications of this tube include swept signal generators, local oscillators in radar receivers and in countermeasures systems, master oscillators in broadband transmitters and parametric amplifier pumps for frequency-agile radars.

All voltages are isolated from the tube housing and rf output connector. Either the grid or anode can be used for rf power leveling or modulation purposes with essentially zero modulating power required.



The SE-214A requires no external cooling while operating at high ambient temperatures and does not have to be mounted on a heat sink. It may be mounted in any position without degrading its performance or adversely affecting operating life.

This Stewart tube is designed to provide greatest possible bandwidth, efficiency, and uniform power output, and yet maintain the smallest possible physical dimensions.

To achieve these goals, the tube uses a bifilar or double helix, each helix operating 180° out of phase with the other (push-pull). The power outputs of the two helices are added in a balun to provide a single-ended rf output and to suppress second harmonic components.

Electron beam configuration is closely controlled by precision gun-stacking techniques¹ and by precision uniform-field magnets. Long life is achieved through careful processing and conservative cathode design (cathode loading is approximately 300 ma/cm²).

Further inquiries may be addressed to the Stewart Applications Engineering or to our representative in your area.

¹ U. S. Patent No. 2,938,133

SPECIFICATION

SE-214A

L-BAND BACKWARD-WAVE OSCILLATOR

PERFORMANCE

Frequency	1.0-2.0 Gc
Power output	100 mw min.
Power output variation	8 db max.
Tube VSWR	2.5:1 max.

ELECTRICAL REQUIREMENTS

Helix voltage	335-1450 v typ.
Anode voltage	150 v typ.
Heater voltage	6.3 \pm 5% v
Heater current	0.6-1.2 a min/max.
Cathode current	17 ma max.

MECHANICAL

Over-all length	10-7/8 inches max.
Weight	12.5 lbs. max.
Output connector	N female
Power input connector	Flying leads

STEWART ENGINEERING COMPANY
Subsidiary of Watkins-Johnson Company
467 Bean Creek Road
Santa Cruz, California

Telephone: Area Code 408 426-4100
TWX: 408 - 423-7545

1 December 1963

Vol. 2, No. 6; August, 1964

SE-215 AND SE-215A

S-BAND BACKWARD-WAVE OSCILLATORS

The Stewart SE-215 and SE-215A oscillators are used extensively in commercial swept signal generators and portable test equipment. In military equipment these tubes are well suited for use as local oscillators in radar and countermeasures systems, and master oscillators in frequency agile transmitters. The SE-215 and 215A have also found application in many other areas including parametric amplifiers and telemetry.

The tube, ready for use, weighs less than seven pounds and occupies a volume of under seventy cubic inches. Mounting is accomplished by four internal self-clinching nuts which are equally spaced on all Stewart tubes of this series to provide ready interchangeability. All of these tubes can be operated from the same power supply.

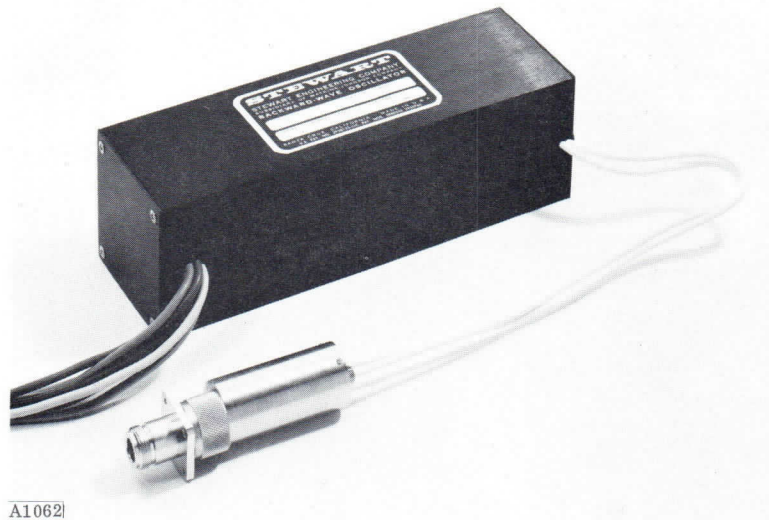

A1062

The slow-wave structure consists of a precision-wound bifilar helix. A highly accurate hollow electron beam provides optimum coupling and good conversion efficiency. A uniform focusing field is provided by a stabilized Alnico magnet and a specially designed field straightener. The field straightener also effectively reduces the sensitivity of the tube to external magnetic disturbances. Power input is provided by means of color-coded flying leads for connection to terminal strips or to a connector. Total power consumption, including heater, is approximately 25 watts. All electrodes are dc isolated from both the "N" connector output and the housing. The type "N" female connector is supplied on a coaxial cable, thus eliminating the need for the user to add elbows or

short coaxial lines with accompanying degradation in performance. It is significant to note that specifications are guaranteed at the cable end, which is typically at the point of use. Conservative design and time-tested manufacturing procedures ensure reliability and long tube life.

The Stewart Engineering Company's square packaging techniques result in a large reduction in weight and volume, along with increased flexibility in system packaging. Utilizing this increased flexibility will permit design of much lighter and smaller S-band equipment.

Further inquiries may be addressed to Stewart Application Engineering, or to our representative in your area.

STEWART ENGINEERING COMPANY
Subsidiary of Watkins-Johnson Company
467 Bean Creek Road
Santa Cruz, California

Telephone: Area Code 408-426-4100
Teletype: Area Code 408-423-7545

STEWART / TECHNICAL DATA

STEWART ENGINEERING COMPANY / Santa Cruz, Calif.
 Subsidiary of Watkins-Johnson Co.

(408) 426-4100
 TWX: (408) 423-7545

BACKWARD-WAVE OSCILLATOR

The Type SE-215A BWO is a bifilar (dual helix), voltage tunable oscillator. This permanent-magnet focused wide band oscillator is well suited for use as a swept signal source in signal generators, particularly in view of its high stability. Other applications include radar receivers (as local oscillator), and ECM equipment. The SE-215A features smooth power over the band, low cathode current, and two control electrodes. The control grid makes possible power cutoff with low negative grid voltage. Power output can be modulated with either the grid or anode, or both. Cathode modulation with the grid grounded usually reduces FM caused by AM. With all voltages isolated from both tube housing and the r.f. output terminal, packaging problems are simplified, since the tube housing and output connector can be grounded regardless of power supply configuration.

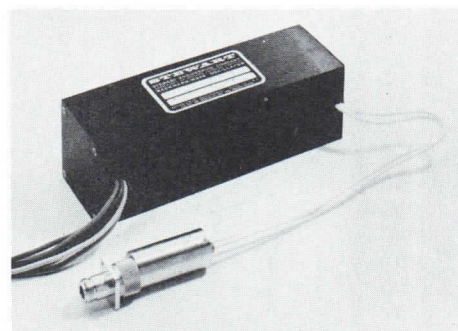

ELECTRICAL CHARACTERISTICS, CW	Typical Values	Absolute Ratings
Nominal Frequency Band, Gc	2-4	*
Power Output into a Load with VSWR=1.25, mW	85-300	75 Min.
Power Output Variation, db		6 Max.
Fine Grain Variation, db/250 mc		3 Max.
Tube VSWR		2.5: 1 Max.
Spurious Oscillation		
Ratio of Signal to 2nd Harmonic Output, db	30	25 Min.
Ratio of Signal to all other Spurious Output, db	55	45 Min.
Long-term sensitivity to Heater Voltage, Mc/V	2	8 Max.
Sensitivity to Anode Voltage, Mc/V	0.25	1.0 Max.
Sensitivity to Grid Voltage, Mc/V	3	6 Max.
Tuning Curve Slope, Mc/V		
Low End (2.0 Gc)	2.5	
Mid-Frequency (3.0 Gc)	1.4	
High End (4.0 Gc)	.85	
Grid r.f. Cutoff Voltage, V	-8	-20 Max.
Capacitance; Cathode to all other Electrodes, including heater, uuf	18	25 Max.
Capacitance; Grid to all other Electrodes at Power Input Plug, uuf	18	25 Max.
Capacitance; Helix to all other Electrodes (12" Coax Cable attached), uuf	250	300 Max.

7/64

ELECTRICAL CHARACTERISTICS, CW (Contd.)

	Typical Values	Absolute Ratings
Heater Voltage, V		6.3 ± 5%
Heater Current, A	0.9	0.6-1.2 Min/Max.
Heater-to-Cathode Leakage ($E_{hk} = \pm 90V$), μA		25 Max.
Cathode Current, mA	8	15 Max.
Helix Voltage Range, V	330-1800	300-1900 Min/Max.
Helix Current, mA	1	3.5 Max.
Anode Voltage, V	130	220 Max.
Anode Current, mA	0.6	1.5 Max.
Anode Supply Impedance, Ohms		50K Max.

MECHANICAL DATA

Length, exclusive of connectors, In.	8.63 Max.
Height and depth, In.	2.55 Max.
Weight, Lbs.	7.25 Max.
Output cable length (Type N Female Connector), In.	12
Power input	Flying leads
Forced air cooling, to + 60°C ambient	None required
Mounting position	Any
Separation from passive magnetic materials, In.	2 Min.

SCHEMATIC DIAGRAM

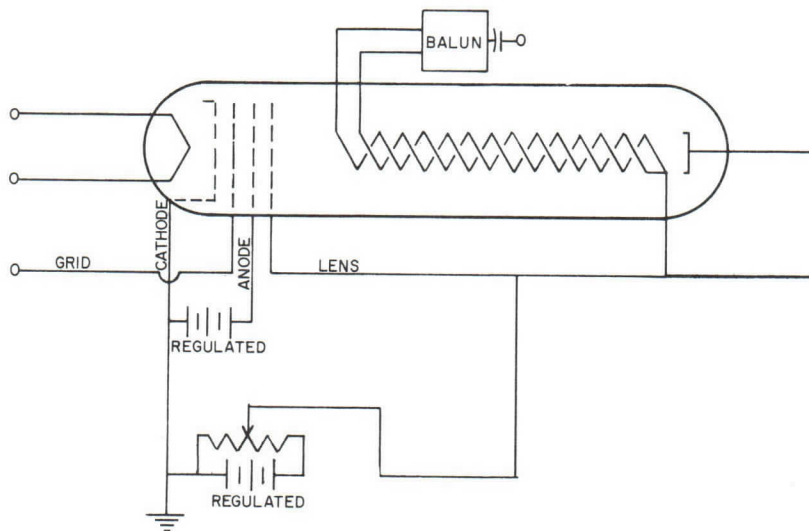

TUNING VOLTAGE

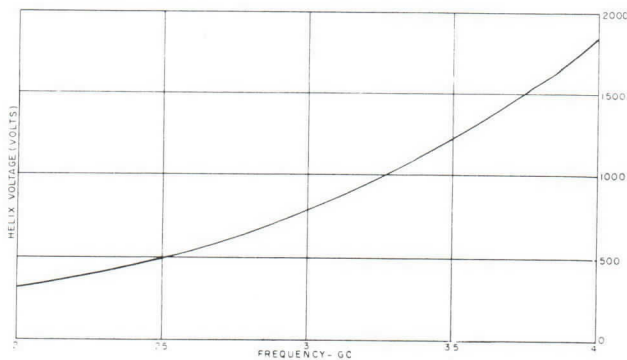

POWER OUTPUT

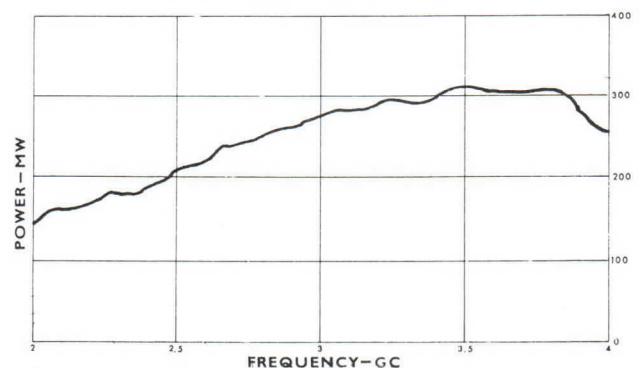

STEWART / TECHNICAL DATA

STEWART ENGINEERING COMPANY / Santa Cruz, Calif.
Subsidiary of Watkins-Johnson Co.(408) 426-4100
TWX: (408) 423-7545

BACKWARD-WAVE OSCILLATOR

The Type SE-215 BWO is a bifilar (dual helix), voltage tunable oscillator. This permanent-magnet focused wide band oscillator is well suited for use as a swept signal source in signal generators, particularly in view of its high stability. Other applications include radar receivers (as local oscillator), frequency diversity transmitters (as master oscillator), and ECM equipment. The SE-215 features smooth power over the band, low cathode current, and two control electrodes. The control grid makes possible power cutoff with low negative grid voltage. Power output can be modulated with either the grid or anode, or both. Cathode modulation with the grid grounded usually reduces FM caused by AM. With all voltages isolated from both tube housing and the r.f. output terminal, packaging problems are simplified, since the tube housing and output connector can be grounded regardless of power supply configuration.

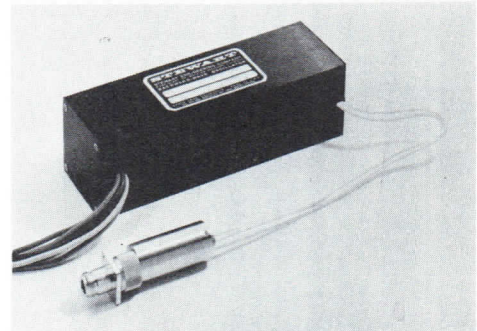

ELECTRICAL CHARACTERISTICS, CW	Typical Values	Absolute Ratings
Nominal Frequency Band, Gc	1.7-4.2	*
Power Output into a Load with VSWR = 1.25, mW	40-300	30 Min.
Power Output Variation, db		9 Max.
Fine Grain Variation, db/250 mc		3 Max.
Tube VSWR		2.5:1 Max.
Spurious Oscillation		
Ratio of Signal to 2nd Harmonic Output, db	30	20 Min.
Ratio of Signal to all other Spurious Output, db	55	45 Min.
Long-term sensitivity to Heater Voltage, Mc/V	2	8 Max.
Sensitivity to Anode Voltage, Mc/V	0.25	1.0 Max.
Sensitivity to Grid Voltage, Mc/V	3	6 Max.
Tuning Curve Slope, Mc/V		
Low End (1.7 Gc)	2.7	
Mid-Frequency (2.95 Gc)	1.4	
High End (4.2 Gc)	.75	
Grid r.f. Cutoff Voltage, V	-8	-20 Max.
Capacitance; Cathode to all other Electrodes, including Heater, uuf	18	25 Max.
Capacitance; Grid to all other Electrodes at Power Input Plug, uuf	18	25 Max.
Capacitance; Helix to all other Electrodes (12" Coax Cable attached), uuf	250	300 Max.

7/64

* Selected tubes with extra power, extra bandwidth, lower power variation and other features are normally available on special order. These are design data only. For operating instructions refer to Stewart Instruction Sheet furnished with tube.

ELECTRICAL CHARACTERISTICS, CW (Contd.)

Heater Voltage, V
 Heater Current, A
 Heater-to-Cathode Leakage ($E_{hk} = \pm 90V$), μA
 Cathode Current, mA
 Helix Voltage Range, V
 Helix Current, mA
 Anode Voltage, V
 Anode Current, mA
 Anode Supply Impedance, Ohms

Typical Values	Absolute Ratings
	6.3 \pm 5%
0.9	0.6-1.2 Min/Max.
	25 Max.
8	15 Max.
235-2030	200-2150 Min/Max.
1	4 Max.
130	220 Max.
0.6	1.5 Max.
	50K Max.

MECHANICAL DATA

Length, exclusive of connectors, In.
 Height and depth, In.
 Weight, Lbs.
 Output cable length (Type N Female Connector), In.
 Power Input
 Forced air cooling, to + 60°C ambient
 Mounting position
 Separation from passive magnetic materials, In.

8.63 Max.
2.55 Max.
7.25 Max.
12
Flying leads
None required
Any
2 Min.

SCHEMATIC DIAGRAM

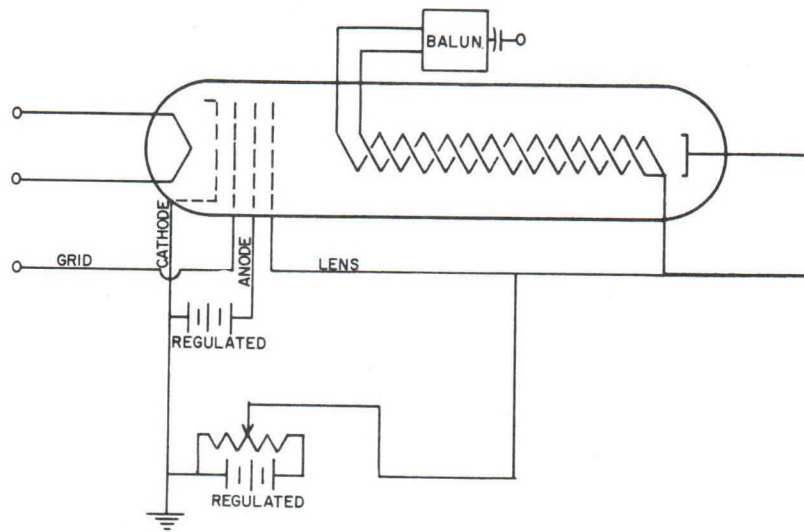

TUNING VOLTAGE

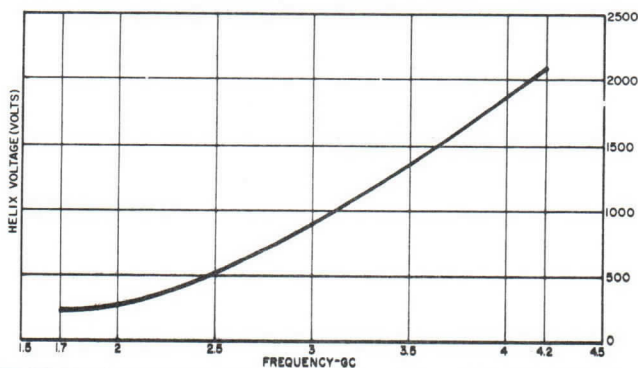

POWER OUTPUT

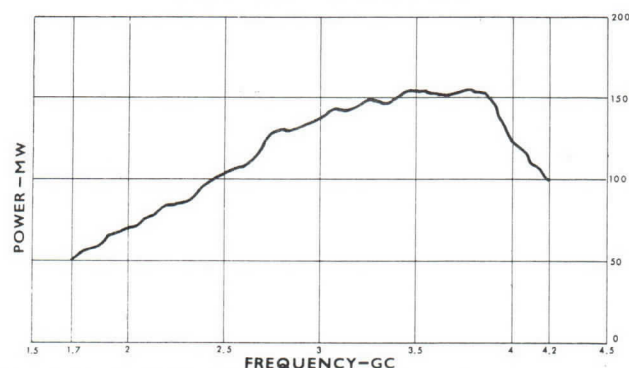



Vol. 7, No. 5; July 1965

SE-221

3.5 TO 6.75 GC BACKWARD-WAVE OSCILLATOR

The SE-221 backward-wave oscillator is a new medium-weight tube designed primarily for use in sweep oscillators and related test equipment. It is also well suited as a local oscillator in radar receivers and countermeasures systems, as master oscillator, and parametric amplifier pump. The straight line package of square cross-section is provided for ease of handling and positioning in or out of equipment. The oscillator is secured in the instrument by using internal mounting nuts. Thus, a sizable flat external surface is provided for good thermal conduction. Internal heat is transferred effectively to the housing through highly conductive epoxies.

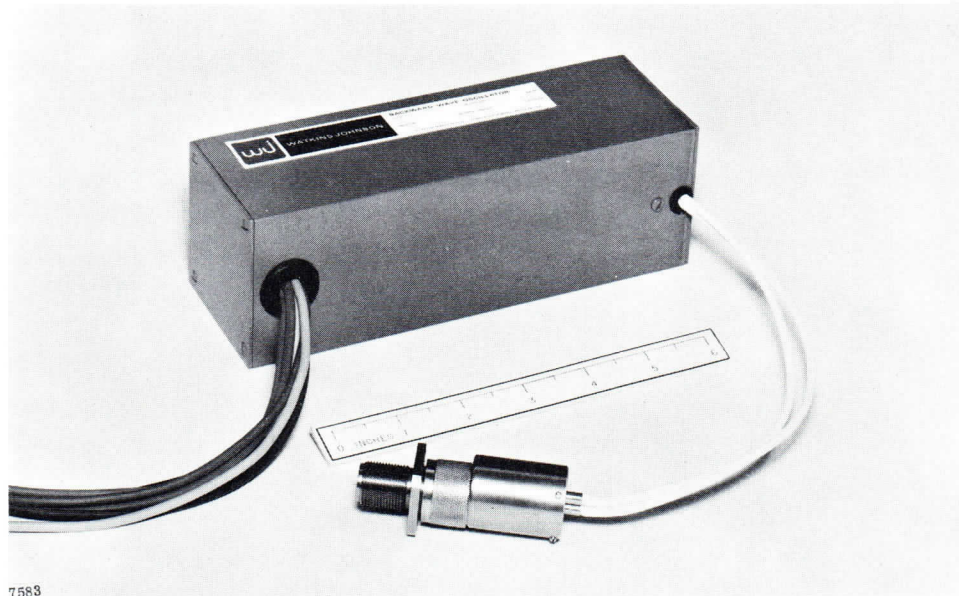

A uniform focusing field is provided by using an Alnico magnet which is stabilized during the charging process to ensure long uniform magnet life, as well as high resistance to environmental changes. The use of proprietary field straightening techniques serves to minimize tube sensitivity to external fields, both ac and dc.

All tube electrodes are dc isolated from both the Type "N" connector output and the housing. The connector is supplied on a flying coaxial cable, thus eliminating the need for the customer to add elbows or short coaxial lines with accompanying degradation in performance.

The delay line used is a precision-wound bifilar helix. The SE-221 helix setting and tightening techniques have been proven in production of over 10,000 backward-wave oscillators. The cold VSWR looking into the tube is normally better than 2:1, which provides for smooth power output curves with excellent fine-grain power variation. The tube will operate successfully into loads with VSWR up to 5:1.

Delay line voltages are chosen consistent with good design for best overall efficiency and minimal modulation sensitivity. The total beam input power is usually less than 16 watts with a beam current of 8 ma.

The SE-221 weighs less than six pounds, and has a volume of 47 in³. This permits design of much lighter weight and smaller S- and C-band test equipment than was heretofore possible.

Further inquiries may be addressed to Watkins-Johnson Applications Engineering, or to our representative in your area.

WATKINS-JOHNSON COMPANY
Stanford Industrial Park
3333 Hillview Avenue
Palo Alto, California

Telephone: (415) 326-8830
Teletype: (910) 373-1253

1 June 1965

SPECIFICATION

SE-221

3.5 TO 6.75 GC BACKWARD WAVE OSCILLATOR

<u>ELECTRICAL CHARACTERISTICS, CW</u>	<u>Typical Values</u>	<u>Absolute Ratings</u>
Nominal Frequency Band, Gc	3.5-6.75	*
Power Output into a Load with VSWR = 1.25, mw	50-130	40 min.
Power Output Variation, db		7 max.
Fine Grain Variation, db/250 Mc		3 max.
Tube VSWR		2.5:1 max.
Spurious Oscillation		
Ratio of Signal to 2nd Harmonic Output, db	30	20 min.
Ratio of Signal to all other Spurious Output, db	60	45 min.
Long-term sensitivity to Heater Voltage, Mc/v	5	10 max.
Sensitivity to Anode Voltage, Mc/v	0.5	1 max.
Sensitivity to Grid Voltage, Mc/v	3.0	5 max.
Tuning Curve Slope, Mc/v		
Low End (3.5 Gc)	5.6	
Mid Frequency (5.1 Gc)	2.2	
High End (6.75 Gc)	1.6	
Grid rf Cutoff Voltage, v	-7	-20 max.
Collector Voltage Above Helix (Note 1), v	50-150	300 max.
Capacitance; Cathode to all other Electrodes		
Including Heater, $\mu\mu\text{f}$	30	45 max.
Capacitance; Grid to all other Electrodes, at		
Power Input Connector, $\mu\mu\text{f}$	30	45 max.
Capacitance; Helix to all other Electrodes (12" Coax Cable attached), $\mu\mu\text{f}$	100	150 max.
Heater Voltage, v		6.3 \pm 5%
Heater Current, a	0.85	0.6-1.2 min/max
Heater-to-Cathode Leakage ($E_{hk} = \pm 90$ v), μa		25 max.
Cathode Current, ma	8.0	12 max.
Helix Voltage Range, v	400-2040	350-2100 min/max
Helix Current, ma	2.0	3.0 max.
Anode Voltage, v	175	250 max.
Anode Current, ma	0.5	2.0 max.
Anode Supply Impedance, Ohms		50K max.

MECHANICAL DATA

Length, exclusive of Connectors, In.		7.75 max.
Height and Depth, In.		2.55 max.
Weight, lbs.		6 max.
Output Cable Length (Type N Connector), In.	13	
Power Input Connector	Flying Leads	
Forced Air Cooling, to +60°C Ambient	None required	
Mounting Position	Any	
Separation from Passive Materials, In.		2 min.

SCHEMATIC DIAGRAM

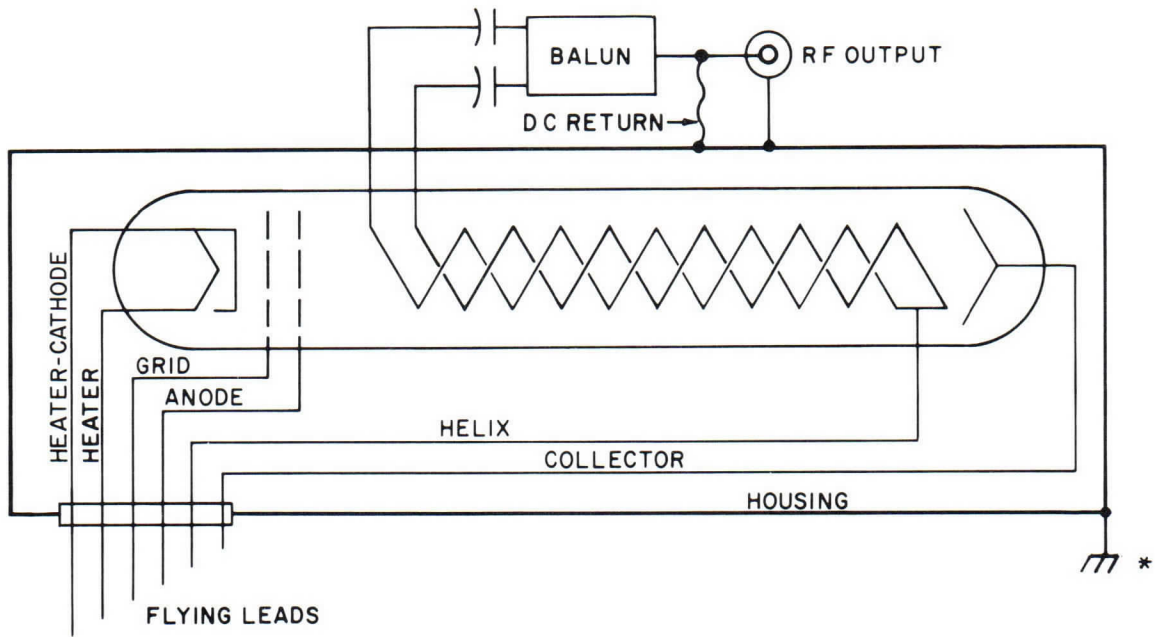

TUNING VOLTAGE

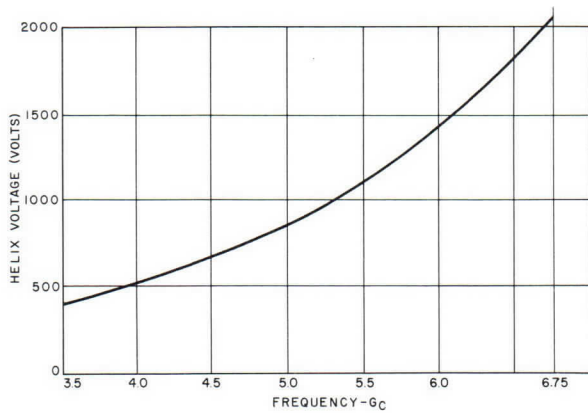

POWER OUTPUT

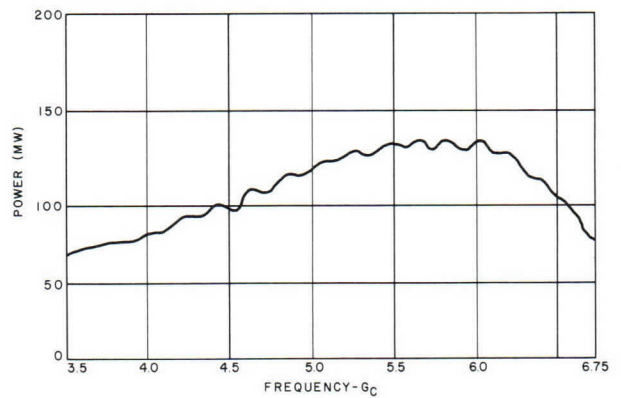

* For safety, housing should be grounded through mounting screws.

BACKWARD-WAVE OSCILLATOR

The Type SE 301 BWO is a single-helix, voltage tunable oscillator. This permanent-magnet focused wide band oscillator is well suited for use in radar receivers (as local oscillator), frequency diversity transmitters (as master oscillator), and ECM equipment. It also serves as a swept signal source in signal generators. The SE 301 features smooth power over the band, low cathode current, and two control electrodes. The control grid makes possible power cutoff with low negative grid voltage. Power output can be modulated with either the grid or anode, or both. Cathode modulation with the grid grounded usually reduces FM caused by AM. With all voltages isolated from both tube housing and the r.f. output terminal, packaging problems are simplified, since the tube housing and output connector can be grounded regardless of power supply configuration. This tube has been designed and tested for rugged environments such as those found in high performance aircraft, missiles and naval vessels.

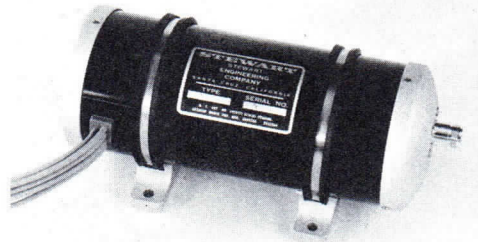

ELECTRICAL CHARACTERISTICS, CW

	Typical Values	Absolute Ratings
Nominal Frequency Band, Gc	7.0-9.1	*
Power Output into Load with VSWR=1.25, mW	120-300	100 Min.
Power Output Variation, db		6 Max.
Fine Grain Variation, db/250 Mc		3 Max.
Tube VSWR		2:1 Max.
Ratio of Signal to Total Spurious Output, db		40 Min.
Spurious output in 2 Mc bands, 30 Mc on each side of carrier, db below carrier	106	90 Max.
Long-term sensitivity to Heater Voltage, Mc/V	3.0	5.0 Max.
Sensitivity to Anode Voltage, Mc/V	0.8	1.0 Max.
Sensitivity to Grid Voltage, Mc/V	3.5	5.0 Max.
Tuning Curve Slope, Mc/V		
Low End (7.0 Gc)	3.0	
Mid-Frequency (8.05 Gc)	2.0	
High End (9.1 Gc)	1.5	
Grid r.f. Cutoff Voltage, V	-10	-20 Max.
Capacitance; Cathode to all other Electrodes including Heater, uuf	38	50
Capacitance; Grid to all other Electrodes, at Power Input Connector, uuf	30	40
Capacitance; r.f. connector center pin and Housing to all other Electrodes, uuf	130	150

ELECTRICAL CHARACTERISTICS, CW (Contd.)

	Typical Values	Absolute Ratings
Heater Voltage		6.3 ± 5%
Heater Current, A	0.9	0.6-1.2 Min/Max.
Heater-to-Cathode Leakage ($E_{hk} = +90V$), μA		25 Max.
Cathode Current, mA	15	25 Max.
Helix Voltage Range, V	770-1900	700-2000 Min/Max.
Helix Current, mA	3	5 Max.
Anode Voltage, V	140	250 Max.
Anode Current, mA	0.5	2.0 Max.
Anode Supply Impedance, Ohms		50K Max.

MECHANICAL DATA

Length, exclusive of Connectors, In.	9-1/4 Max.
Height, In.	4-1/4 Max.
Weight, Lbs.	12 Max.
Separation from Passive Magnetic Materials, In.	2 Min.
Forced Air Cooling, to +60°C Ambient	None required
Shock, 3 axes, both directions	30g
Vibration, operating	5-1500 cps, to 10g
Altitude, ft.	55,000
Temperature, operating, °C	-65 to +60

SCHEMATIC DIAGRAM

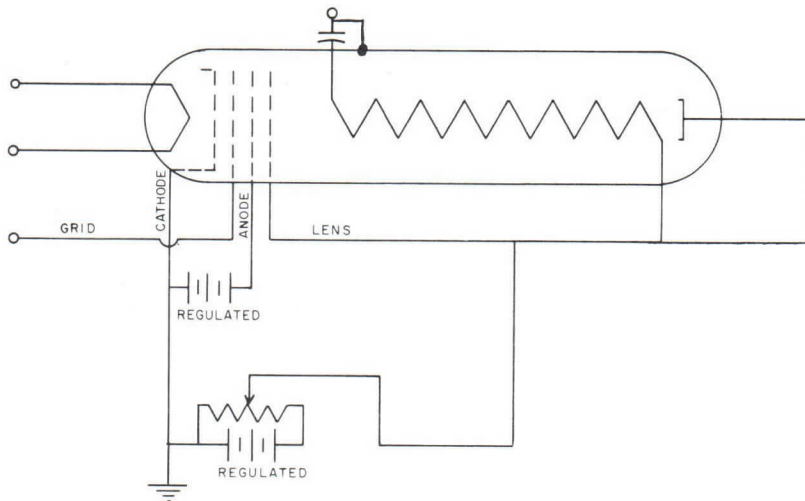

TUNING VOLTAGE

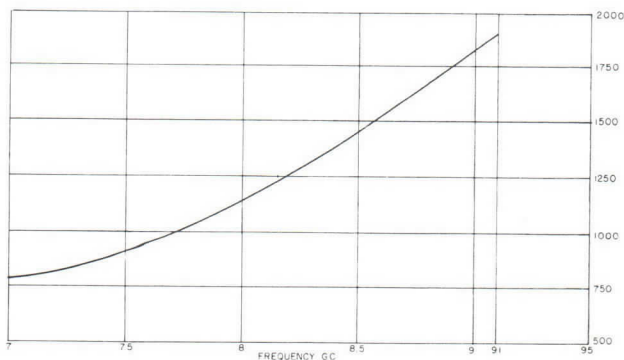

POWER OUTPUT

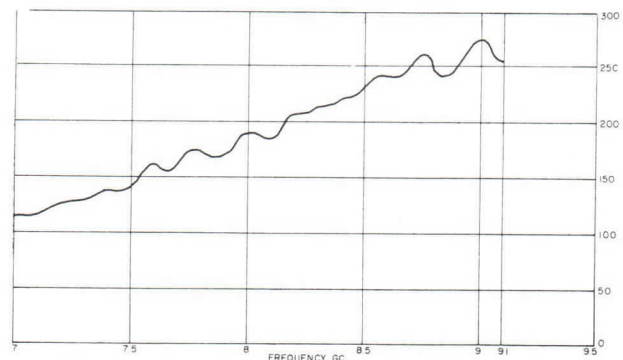

BACKWARD-WAVE OSCILLATOR

The Type SE 302 BWO is a single-helix, voltage tunable oscillator. This permanent-magnet focused wide band oscillator is well suited for use in radar receivers (as local oscillator), frequency diversity transmitters (as master oscillator), and ECM equipment. It also serves as a swept signal source in signal generators. The SE 302 features smooth power over the band, low cathode current, and two control electrodes. The control grid makes possible power cutoff with low negative grid voltage. Power output can be modulated with either the grid or anode, or both. Cathode modulation with the grid grounded usually reduces FM caused by AM. With all voltages isolated from both tube housing and the r.f. output terminal, packaging problems are simplified, since the tube housing and output connector can be grounded regardless of power supply configuration. This tube has been designed and tested for rugged environments such as those found in high performance aircraft, missiles and naval vessels.

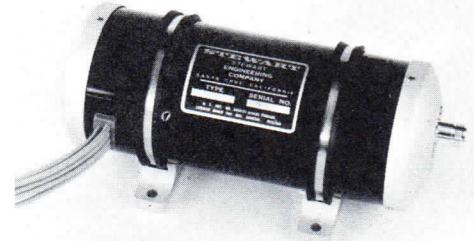

ELECTRICAL CHARACTERISTICS, CW	Typical Values	Absolute Ratings
Nominal Frequency Band, Gc	8.5-9.6	*
Power Output into Load with VSWR=1.25, mW	120-250	100 Min.
Power Output Variation, db		4 Max.
Fine Grain Variation, db/250 Mc		3 Max.
Tube VSWR		2:1 Max.
Ratio of Signal to Total Spurious Output, db		40 Min.
Spurious output in 2 Mc bands, 30 Mc on each side of carrier, db below carrier	106	90 Max.
Long-term sensitivity to Heater Voltage, Mc/V	3.0	5.0 Max.
Sensitivity to Anode Voltage, Mc/V	0.8	1.0 Max.
Sensitivity to Grid Voltage, Mc/V	3.5	5.0 Max.
Tuning Curve Slope, Mc/V		
Low End (8.5 Gc)	1.9	
Mid-Frequency (9.05 Gc)	1.7	
High End (9.6 Gc)	1.5	
Grid r.f. Cutoff Voltage, V	-10	-20 Max.
Capacitance; Cathode to all other Electrodes Including Heater, uuf	38	50
Capacitance; Grid to all other Electrodes, at Power Input Connector, uuf	30	40
Capacitance; r.f. connector center pin and Housing to all other Electrodes, uuf	130	150

11/63

ELECTRICAL CHARACTERISTICS, CW (Contd.)

	Typical Values	Absolute Ratings
Heater Voltage, V		6.3 ± 5%
Heater Current, A	0.9	0.6-1.2 Min/Max.
Heater-to-Cathode Leakage ($E_{hk} = \pm 90V$), μA		25 Max.
Cathode Current, mA	15	25 Max.
Helix Voltage Range, V	970-1600	900-1700 Min/Max.
Helix Current, mA	3	5 Max.
Anode Voltage, V	140	250 Max.
Anode Current, mA	0.5	2.0 Max.
Anode Supply Impedance, Ohms		50K Max.

MECHANICAL DATA

Length, exclusive of Connectors, In.	9-1/4 Max.
Height, In.	4-1/4 Max.
Weight, Lbs.	12 Max.
Separation from Passive Magnetic Materials, In.	2 Min.
Forced Air Cooling, to +60°C Ambient	None required
Shock, 3 axes, both directions	30g
Vibration, operating	5-1500 cps, to 10
Altitude, ft.	55,000
Temperature, operating, °C	-65 to +60

SCHEMATIC DIAGRAM

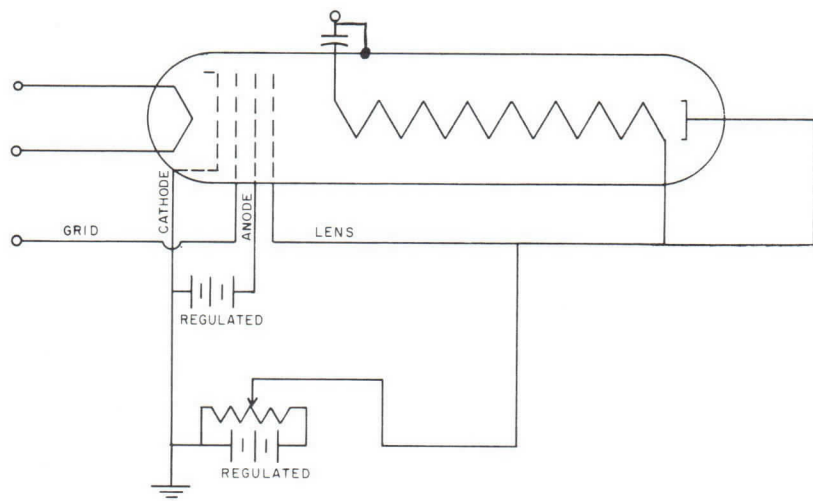

TUNING VOLTAGE

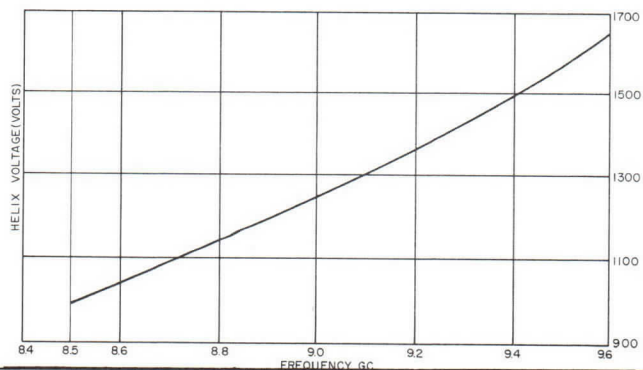

POWER OUTPUT

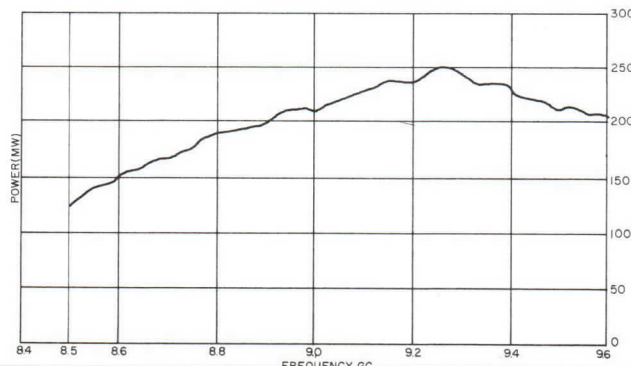

TENTATIVE

BACKWARD-WAVE OSCILLATOR

The Stewart Type SE 303 is a single-helix, voltage tunable oscillator utilizing a permanent-magnet focusing system. The miniature square package features rugged construction and capability to withstand severe environmental conditions. The size and weight of this package is comparable to electrostatically-focused BWO's in this band, but with superior performance, reliability and reduced power supply requirements. Thus, it is ideal for space, airborne and shipboard applications as a local oscillator in swept or FM receivers, master oscillator in transmitters and ECM jammers, signal source in generators, etc.. Fine grain variation of frequency vs. voltage is extremely low. Power output and tuning curves are uniform and highly reproducible. Power can be modulated and leveled with either grid or anode circuits. All voltages are isolated from the housing and r.f. connector for easier packaging.

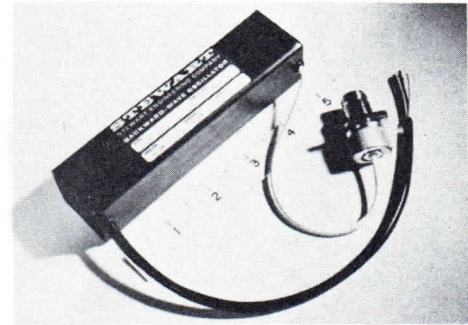

ELECTRICAL CHARACTERISTICS, CW	Typical Values	Absolute Ratings
Nominal Frequency Band, Gc	8.2-12.4	*
Power Output into Load with VSWR = 1.25 mW	25-50	20 Min.
Power Output Variation, db		6 Max.
Fine Grain Variation, db/250mc		3 Max.
Tube VSWR		2:1 Max.
Ratio of Signal to Total Spurious Output, db	60	45 Min.
Long-term sensitivity to Heater Voltage, Mc/V	7.5	10 Max.
Sensitivity to Anode Voltage, Mc/V	0.5	1.0 Max.
Sensitivity to Grid Voltage, Mc/V	2	4 Max.
Tuning Curve Slope, Mc/V		
Low End (8.2 Gc)	7.0	
Mid-Frequency (10.3 Gc)	3.5	
High End (12.4 Gc)	1.5	
Grid r.f. Cutoff Voltage, V	-10	-20 Max.
Capacitance; Cathode to all other Electrodes inc. Heater, μ f	15	20 Max.
Capacitance; Grid to all other Electrodes, at Power Input Connector, μ f	18	25 Max.
Capacitance; r.f. connector center pin and Housing to all other Electrodes, μ f	120	135 Max.

10/63

* Selected tubes with extra power, extra bandwidth, lower power variation and other features are normally available on special order. These are design data only. For operating instructions refer to Stewart Instruction Sheet furnished with tube.

ELECTRICAL CHARACTERISTICS, CW (Contd.)

Heater Voltage, V
 Heater Current, A
 Heater-to-Cathode Leakage ($E_{hk} = -90V$), μA
 Cathode Current, mA
 Helix Voltage Range, V
 Anode Voltage, V
 Anode Current, mA
 Anode Supply Impedance, Ohms

Typical Values	Absolute Ratings
	6.3 \pm 5%
0.9	0.6-1.2 Min/Max.
	25 Max.
8	12 Max.
500-2000	450-2100 Min/Max.
150	250 Max.
0.5	2 Max.
	50K Max.

MECHANICAL DATA

Length, Exclusive of Connectors, In.
 Cross-Section, In.
 Weight, Lbs.
 R.f. Output Connector
 Power Input Connector
 Forced Air Cooling, to +60°C Ambient
 Mounting Position
 Separation from Passive Magnetic Materials, In.
 Designed to meet severe environmental conditions.

6 Max.
 1-1/2 x 1-1/2 Max.
 1-1/2
 Type N Female
 Flying Leads
 None Required
 Any
 2 Min.

SCHEMATIC DIAGRAM

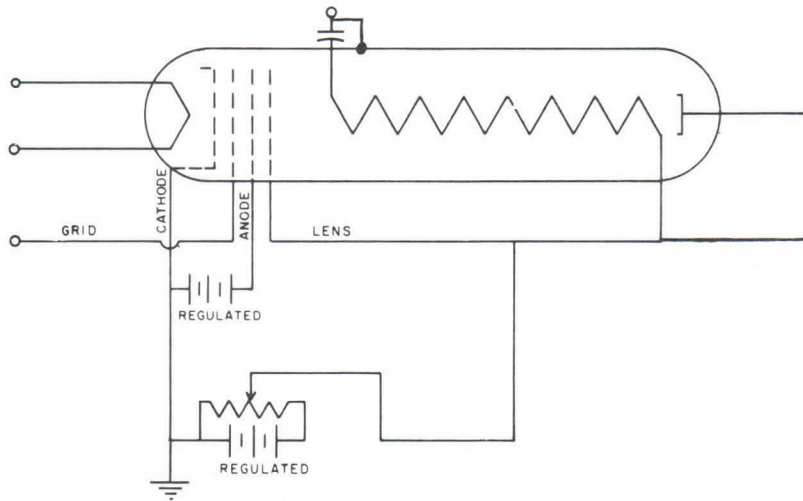

TUNING VOLTAGE

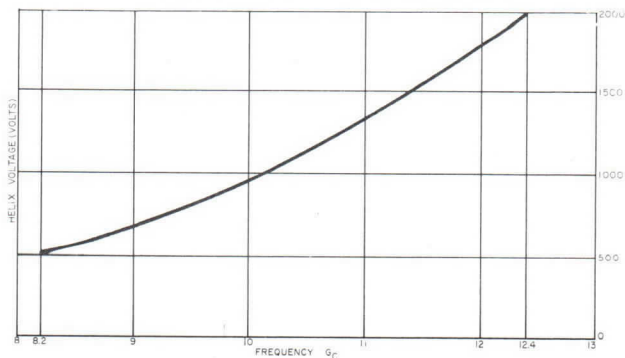

POWER OUTPUT



Vol. 1, No. 5; November, 1963

SE-303

MINIATURE X-BAND BACKWARD-WAVE OSCILLATOR

The SE-303 is an extremely light-weight, small-package permanent-magnet-focused backward-wave oscillator designed to meet both commercial and military requirements.

The tube utilizes a precision wound monofilar helix for the slow-wave structure and employs a closely coupled hollow electron beam for maximum rf efficiency with minimum dissipation. Under normal operation the total input power is less than 20 watts, including heater power.

Weighing 1 1/2 lbs., the tube requires a volume of less than 13 cubic inches, which is quite competitive with oscillators employing other focusing systems (e. g. , electrostatic).

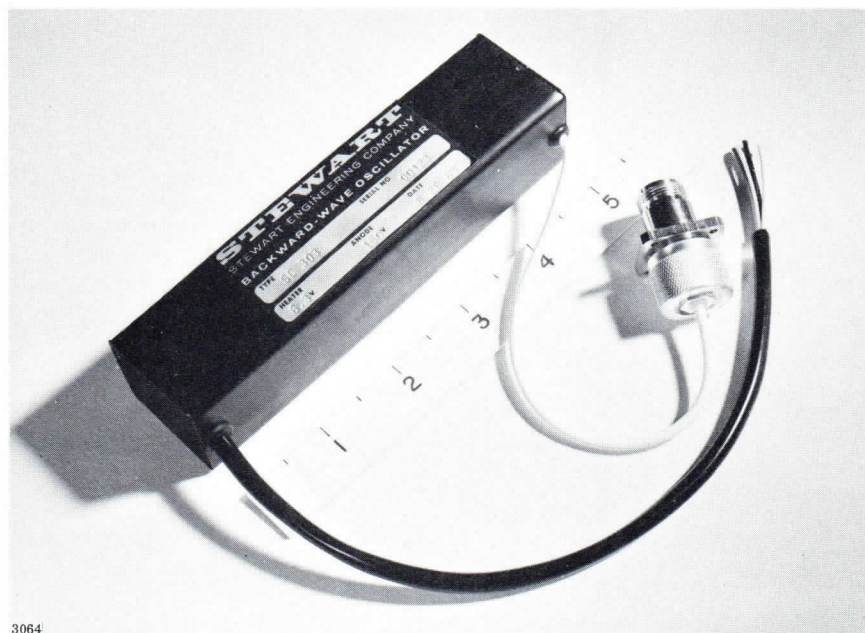

The use of advanced field straightening techniques and optimum magnet design results in equivalent tube performance to much larger, heavier packages.

The tube may be mounted in any position. Its square cross-section permits convenient packaging and good thermal conductivity.

The SE-303 is designed to meet MIL-E-5400 environmental conditions.

Further inquiries may be addressed to Stewart Applications Engineering or to our representative in your area.

TENTATIVE SPECIFICATION

SE-303

MINIATURE X-BAND BACKWARD-WAVE OSCILLATOR

PERFORMANCE

Frequency	8.2-12.4 Gc
Power output	20 mw min.
Power output variation	6 db max.
Tube VSWR	3:1 max.

ELECTRICAL REQUIREMENTS

Helix voltage	500-2000 v typ.
Anode voltage	180 v typ.
Heater voltage	$6.3 \pm 5\%$ v
Heater current	0.6-1.2 a min/max.
Cathode current	12 ma max.

MECHANICAL

Over-all length	6 inches max.
Cross section	1 1/2 in. x 1 1/2 in.
Weight	1 1/2 lbs. typ.
Output connector	Type N female on coax cable
Power input	Flying leads

STEWART ENGINEERING COMPANY
Subsidiary of Watkins-Johnson Company
467 Bean Creek Road
Santa Cruz, California

1 November 1963

Telephone: Area Code 408 - 426-4100
Teletype: Area Code 408 - 423-7545

Vol. 2, No. 3; March, 1964

SE-304

C-BAND BACKWARD-WAVE OSCILLATOR

The SE-304 is the new lightweight, miniaturized, ruggedized C-band backward-wave oscillator designed and developed by Stewart for use primarily in military equipment systems. Its volume of 13.5 cubic inches, weight of 1.5 lbs. and power consumption of less than 15 watts makes it ideal for airborne and space applications in wide-band microwave systems. The tube is capable of meeting severe shock and vibration levels without isolation mounting, and requires no cooling for ambient temperatures up to 85°C.

The delay line used is a precisely wound bifilar helix, the dual rf outputs being combined in a coaxial balun. A closely spaced hollow beam is employed for maximum efficiency. An oxide cathode is used, and under typical operations the current density is less than 200 ma/cm². A uniform focusing field is provided by a stabilized Alnico magnet and a precision stacked field straightener. This field straightener also reduces the sensitivity of the tube to external transverse fields.

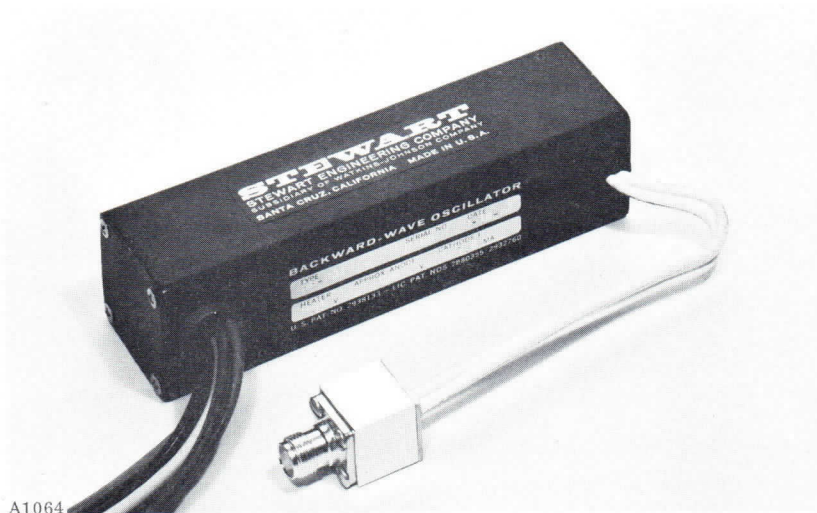

A1064

The housing features smooth straight-line design with flush-mounted nuts for easy mounting. The tube is mechanically interchangeable with the SE-303 and other upcoming types in this family.

The TNC connector and balun combination is supplied on flying coaxial cable, thus eliminating the need for users to add elbows or short coaxial lines with consequent degradation in performance. Power input is by means of color-coded flying leads for connection to a terminal strip.

Further inquiries as to availability, special packaging, bandwidth variations, or selected power output may be addressed to Stewart Applications Engineering or to our representative in your area.

BACKWARD-WAVE OSCILLATOR

The Stewart Type SE 304 BWO is a bifilar (dual-helix) voltage tunable oscillator utilizing a permanent-magnet focusing system. The miniature square package features rugged construction and capability to withstand severe environmental conditions. The size and weight of this package are comparable to electrostatically - focused BWO's in this band, but with superior performance, reliability and reduced power supply requirements. Thus, it is ideal for space, airborne and shipboard applications as a local oscillator in swept or FM receivers, master oscillator in transmitters and ECM jammers, signal source in generators, etc. Fine grain variation of frequency vs. voltage is extremely low. Power output and tuning curves are uniform and highly reproducible. Power can be modulated and leveled with either grid or anode circuits. Helix and collector are grounded to the housing.

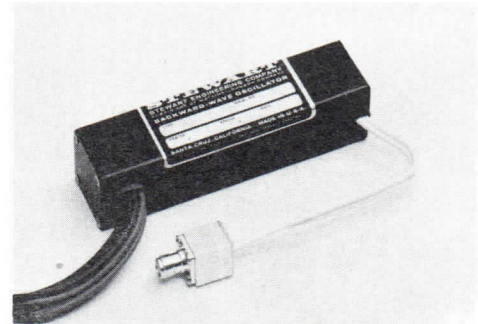

ELECTRICAL CHARACTERISTICS, CW

	Typical Values	Absolute Ratings
Nominal Frequency Band, Gc	4.0-8.0	*
Power Output into Load with VSWR = 1.25 mW	30-70	20 Min.
Power Output Variation, db		6 Max.
Fine Grain Variation, db/250 mc		3 Max.
Tube VSWR		2.5:1 Max.
Ratio of Signal to Total Spurious Output, db	60	45 Min.
Long-term sensitivity to Heater Voltage, Mc/V	5	10 Max.
Sensitivity to Anode Voltage, Mc/V	0.5	1.0 Max.
Sensitivity to Grid Voltage, Mc/V	3	5 Max.
Tuning Curve Slope, Mc/V		
Low End (4.0 Gc)	5.9	
Mid-Frequency (6.0 Gc)	2.7	
High End (8.0 Gc)	2.0	
Grid r.f. Cutoff Voltage, V	-7	-20 Max.
Capacitance; Cathode to all other Electrodes, inc. Heater, uuf	18	25 Max.
Capacitance; Grid to all other Electrodes, at Power Input Connector, uuf	18	25 Max.
Capacitance; r.f. connector center pin and housing to all other electrodes, uuf	90	125 Max.

* Selected tubes with extra power, extra bandwidth, lower power variation and other features are normally available on special order. These are design data only. For operating instructions refer to Stewart Instruction Sheet furnished with tube.

ELECTRICAL CHARACTERISTICS, CW (Contd.)

Heater Voltage, V
 Heater Current, A
 Heater-to-Cathode Leakage ($E_{hk} = -90V$), μA
 Cathode Current, mA
 Helix Voltage Range, V
 Anode Voltage, V
 Anode Current, mA
 Anode Supply Impedance, Ohms

Typical Values	Absolute Ratings
	$6.3 \pm 5\%$
0.6	0.4-1.0 Min/Max.
	25 Max.
8	12 Max.
310-1825	250-1900 Min/Max.
150	250 Max.
0.5	2 Max.
	50K Max.

MECHANICAL DATA

Length, In.
 Cross-Section, In.
 Weight, Lbs.
 R.F. Output Connector
 Power Input
 Forced Air Cooling, to $+60^{\circ}C$ Ambient
 Mounting Position
 Separation from Passive Magnetic Materials, In.
 Designed to meet severe environmental conditions

6 Max.
 1-1/2 x 1-1/2 Max.
 1-1/2
 TNC Female
 Flying Leads
 None Required
 Any
 2 Min.

SCHEMATIC DIAGRAM

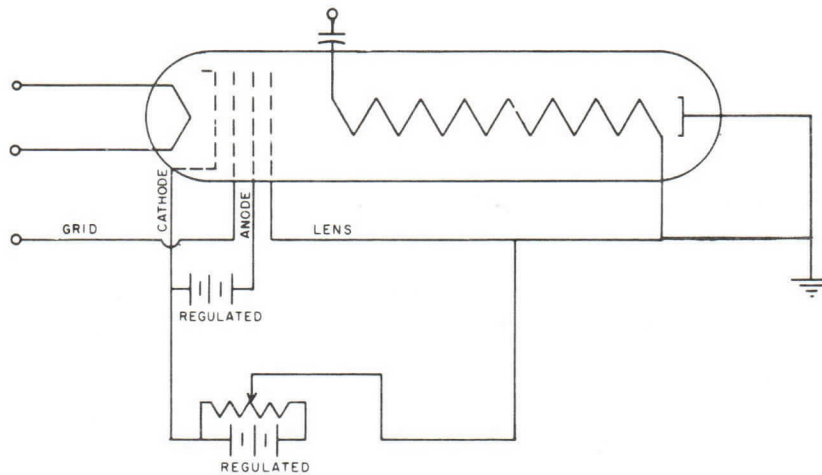

TUNING VOLTAGE

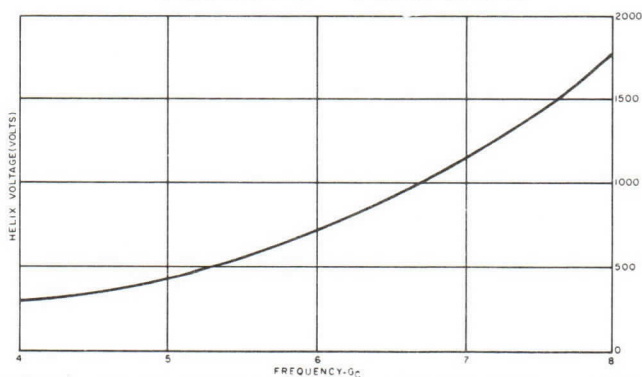

POWER OUTPUT

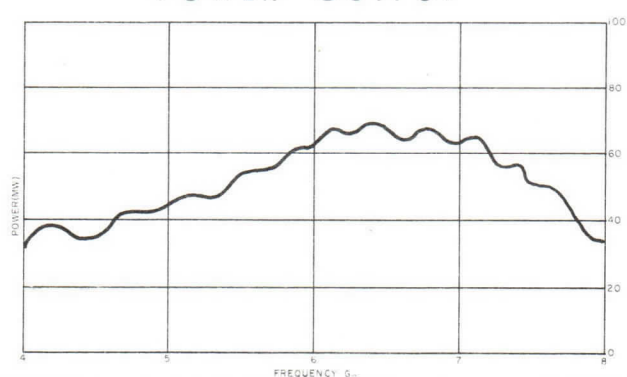

Vol. 2, No. 5; June, 1964

SE-307 AND SE-307A

K_u -BAND BACKWARD-WAVE OSCILLATOR

The SE-307 is the light-weight wide-band "O" type backward-wave oscillator that operates over the frequency range of 12.4 to 18 Gc. This tube has a power output of 10 mw minimum with a total power variation of less than 6 db. Maximum helix voltage is 2000 volts and typical beam current is 7 ma.

Types SE-307 and SE-307A are identical except that the SE-307 has a low-voltage negative grid (useful for square-wave modulation and power leveling) and the SE-307A does not. In either tube, however, the anode may be used for amplitude modulation.

The tube measures 1.5 x 1.5 x 6 inches and has a maximum weight of 1.75 lbs. Power output is via a flexible coaxial cable and waveguide adapter. Flying leads are provided for power input. Focusing is accomplished through the use of a conventional tubular magnet.

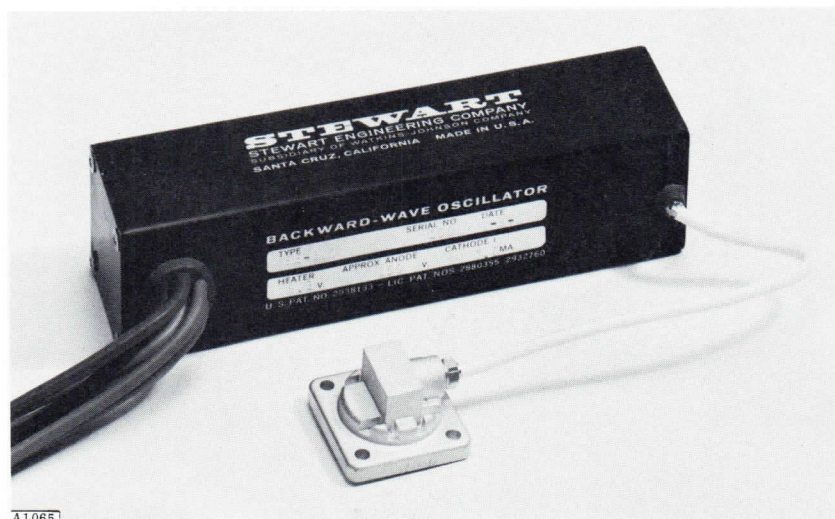

The SE-307 meets shock, vibration, temperature and altitude conditions with a minimum of FM and AM. This is accomplished by using a rugged electron gun assembly and a precisely set and rigid helix structure. Reliability is assured through accurately controlled extensive tube processing and advanced tube packaging techniques.

Total power supply requirement is less than 20 watts. All electrodes are dc isolated so that the tube may be operated with an arbitrary power supply configuration.

The SE-307 and SE-307A are further additions to Stewart line of light-weight miniature BWO packages and join the SE-303, SE-304 and SE-308 in giving full coverage in the 4 to 18 Gc range.

Further inquiries as to availability of standard tubes, as well as special variations, in bandwidth, power output, special packaging and other parameters may be addressed to Stewart Applications Engineering, or to our representative in your area.

STEWART ENGINEERING COMPANY
Subsidiary of Watkins-Johnson Company
467 Bean Creek Road
Santa Cruz, California

Telephone: Area Code 408 - 426-4100
Teletype: Area Code 408 - 423-7545

BACKWARD-WAVE OSCILLATOR

The Stewart Type SE-307 is a single-helix, voltage tunable oscillator utilizing a permanent-magnet focusing system. The miniature square package features rugged construction and capability to withstand severe environmental conditions. The size and weight of this package is comparable to electrostatically-focused BWO's in this band, but with superior performance, reliability and reduced power supply requirements. Thus, it is ideal for space, airborne and shipboard applications as a local oscillator in swept or FM receivers, master oscillator in transmitters and ECM jammers, signal source in generators, etc. Fine grain variation of frequency vs. voltage is extremely low. Power output and tuning curves are uniform and highly reproducible. Power can be modulated and leveled with either grid or anode circuits. All voltages are isolated from the housing and r.f. connector for easier packaging.

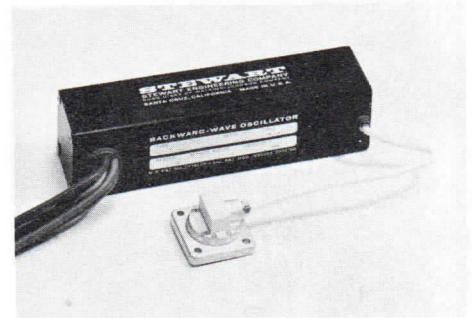

ELECTRICAL CHARACTERISTICS, CW

	Typical Values	Absolute Ratings
Nominal Frequency Band, Gc	12.4-18.0	*
Power Output into Load with VSWR=1.25:1, mW	14-50	10 Min.
Power Output Variation, db		6 Max.
Fine Grain Variation, db/250 Mc		3 Max.
Tube VSWR		2.5:1 Max.
Ratio of Signal to Total Spurious Output, db	60	45 Min.
Long-term sensitivity to Heater Voltage, Mc/V	5	10 Max.
Sensitivity to Anode Voltage, Mc/V	0.5	1.0 Max.
Sensitivity to Grid Voltage, Mc/V	3	6 Max.
Tuning Curve Slope, Mc/V		
Low End (12.4 Gc)	8.7	
Mid-Frequency (15.2 Gc)	4.4	
High End (18.0 Gc)	2.2	
Grid r.f. Cutoff Voltage, V	-10	-20 Max.
Capacitance; Cathode to all other electrodes inc. Heater, uuf	15	20 Max.
Capacitance; Grid to all other electrodes, at Power Input Connector, uuf	18	25 Max.
Capacitance; r.f. connector center pin and Housing to all other Electrodes, uuf	120	135 Max.

ELECTRICAL CHARACTERISTICS, CW (Contd.)

Heater Voltage, V
 Heater Current, A
 Heater-to-Cathode Leakage ($E_{hk} = -90V$), μA
 Cathode Current, mA
 Helix Voltage Range, V
 Anode Voltage, V
 Anode Current, mA
 Anode Supply Impedance, Ohms

Typical Values	Absolute Ratings
	6.3 \pm 5%
0.9	0.6-1.2 Min/Max.
	25 Max.
8	12 Max.
570-1980	500-2100 Min/Max.
150	250 Max.
0.5	2 Max.
	50K Max.

MECHANICAL DATA

Length, exclusive of Connectors, In.
 Cross-Section, In.
 Weight, Lbs.
 R.F. Output Connector
 Power Input Connector
 Forced Air Cooling, to +60°C Ambient
 Mounting Position
 Separation from passive magnetic materials, In.
 Designed to meet severe environmental conditions.

6 Max.
 1-1/2 x 1-1/2 Max.
 1-1/2
 UG 419/U Flange
 Flying Leads
 None required
 Any
 2 Min.

SCHEMATIC DIAGRAM

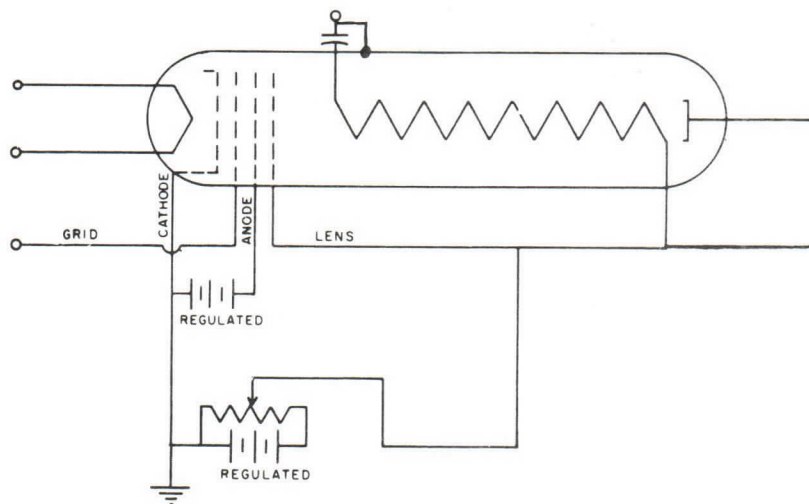

TUNING VOLTAGE

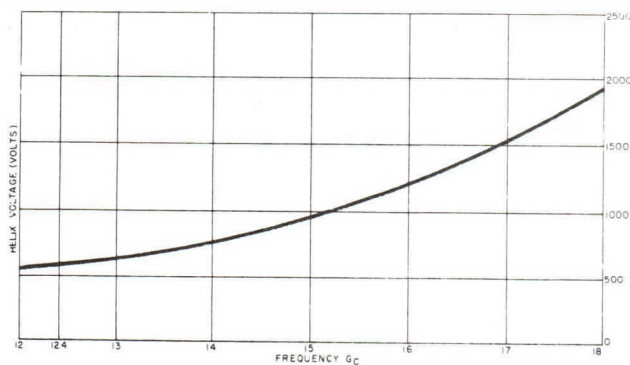

POWER OUTPUT

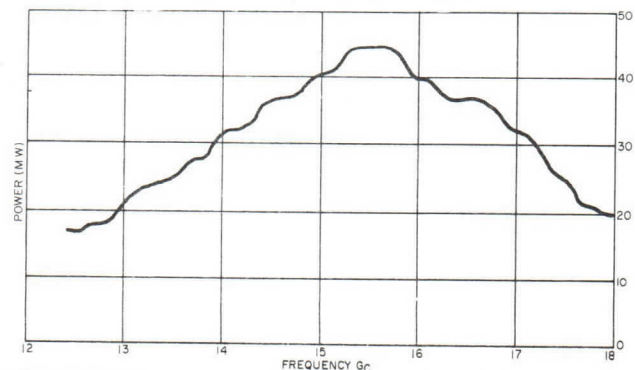

Vol. 2, No. 4; April, 1964

SE-308

MINIATURE KU-BAND BACKWARD-WAVE OSCILLATOR

This Technical Bulletin describes the SE-308, a backward-wave oscillator that will operate over the frequency range from 14 to 17 Gc with a helix voltage range of 400 to 800 volts and a beam current of only 7 ma. The truly unique feature of this tube is that it is a conventional permanent magnet focused backward-wave oscillator, but in a package of only 1.25 x 1.25 x 4 inches, and a weight of only 13 ounces.

Because of the exceedingly simple power supply requirements (the maximum input power is 9 watts including heater), this tube far surpasses an electrostatically-focused tube in any actual system application where the combined weight and complexity of tube and power supply must be considered.

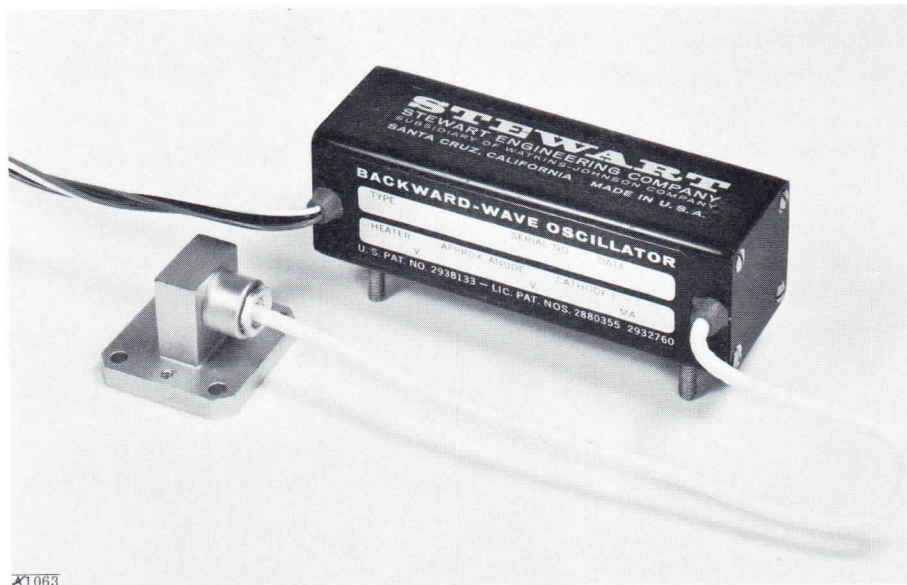

The SE-308 meets extreme operating shock, vibration, and temperature conditions with a minimum of FM and AM. The construction features are similar to those used in the Watkins-Johnson line of reliable, long-life traveling-wave tubes for satellite applications.

The tube incorporates a highly ruggedized electron gun wherein the anode, cathode and other parts are securely joined together in a rigid assembly, and then mounted to eliminate any relative motion between the gun, helix, envelope, and magnet. This method results in precise tolerances easily maintained throughout the life of the tube, even under the most difficult operating environments. The helix is precision set to ensure an extremely smooth tuning curve. The tube will track within ± 10 Mc of a straight line frequency-voltage curve over a 5 percent frequency range when operating into a 1.5:1 mismatch of arbitrary phase.

The rf output waveguide adapter is supplied on a flying coaxial lead for ease of mounting. The tube requires no cooling other than the heat sink cooling provided by the equipment chassis for ambient temperature ranges to 125°C. All tube elements are electrically insulated so that the tube may be operated with an arbitrary power supply ground.

On special order, tubes covering any other 3 Gc range in Ku-band are available. Narrower-range tubes with more power output can also be furnished.

STEWART ENGINEERING COMPANY
Subsidiary of Watkins-Johnson Company
467 Bean Creek Road
Santa Cruz, California

Telephone: Area Code 408 - 426-4100
Teletype: Area Code 408 - 423-7545

1 April 1964

BACKWARD-WAVE OSCILLATOR

The Stewart Type SE-308 is a single-helix, voltage tunable oscillator utilizing a permanent-magnet focusing system. The miniature square package features rugged construction and capability to withstand severe environmental conditions. The size and weight of this package are comparable to electrostatically-focused BWO's in this band, but with superior performance, reliability and reduced power supply requirements. Thus, it is ideal for space, airborne and shipboard applications as a local oscillator in swept or FM receivers, master oscillator in transmitters and ECM jammers, signal source in generators, etc. Fine grain variation of frequency vs. voltage is extremely low. Power output and tuning curves are uniform and highly reproducible. Power can be modulated and leveled with either grid or anode circuits. All voltages are isolated from the housing and r.f. connector for easier packaging.

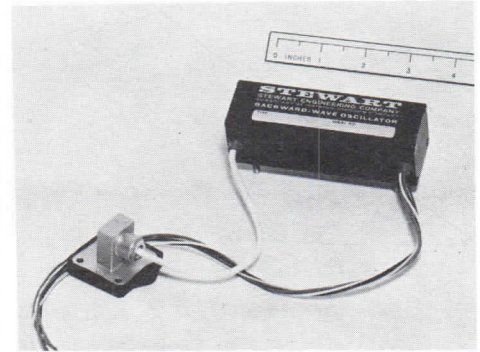

ELECTRICAL CHARACTERISTICS, CW

	Typical Values	Absolute Ratings
Nominal Frequency Band, Gc	14.0-17.0	*
Power Output into Load with VSWR=1.25 mW	10-25	10 Min.
Power Output Variation, db		6 Max.
Fine Grain Variation, db/250mc		3 Max.
Tube VSWR		2.5:1 Max.
Ratio of Signal to Total Spurious Output, db	60	45 Min.
Long-term sensitivity to Heater Voltage, Mc/V	5	10 Max.
Sensitivity to Anode Voltage, Mc/V	0.5	1.5 Max.
Sensitivity to Grid Voltage, Mc/V	3	6 Max.
Tuning Curve Slope, Mc/V		
Low End (14 Gc)	10.5	
Mid-Frequency (15.5 Gc)	8.0	
High End (17 Gc)	6.0	
Grid r.f. Cutoff Voltage, V	-10	-20 Max.
Capacitance; Cathode to all other electrodes inc. heater, uuf	15	20 Max.
Capacitance; Grid to all other electrodes, at power input connector, uuf	18	25 Max.
Capacitance; r.f. connector center pin and housing to all other electrodes, uuf	100	125 Max.

ELECTRICAL CHARACTERISTICS, CW (Contd.)

	Typical Values	Absolute Ratings
Heater Voltage, V		6.3 ± 5%
Heater Current, A	0.6	0.4-1.0 Min/Max.
Heater-to-Cathode Leakage ($E_{hk} = -90V$), μA		25 Max.
Cathode Current, mA	8	12 Max.
Helix Voltage Range, V	405-760	375-800 Min/Max.
Anode Voltage, V	150	250 Max.
Anode Current, mA	0.5	2 Max.
Anode Supply Impedance, Ohms		50K Max.

MECHANICAL DATA

Length, exclusive of connectors, In.	4 Max.
Cross-Section, In.	1-1/4x1-1/4 Max.
Weight, Lbs.	1
R.f. Output Connector	UG 419/U Flange
Power Input Connector	Flying Leads
Forced Air Cooling, to +85°C Ambient	None required
Mounting Position	Any
Separation from Passive Magnetic Materials, In.	2 Min.
Designed to meet severe environmental conditions.	

SCHEMATIC DIAGRAM

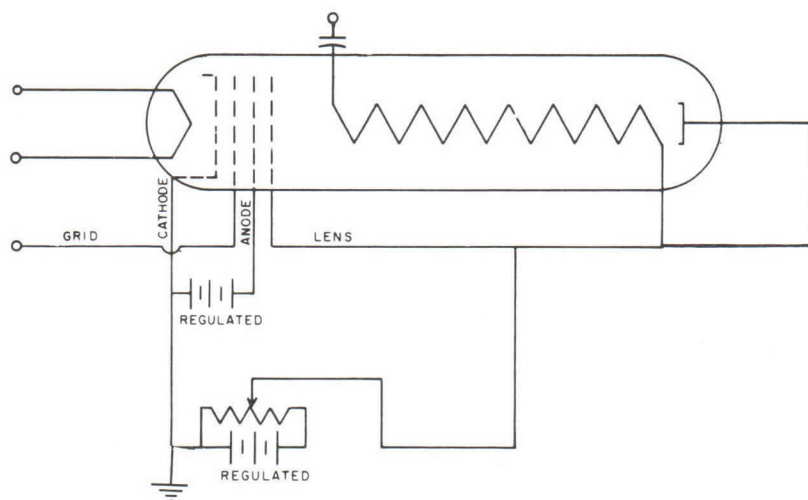

TUNING VOLTAGE

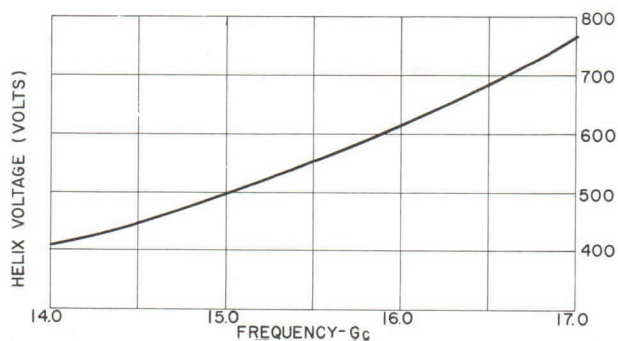

POWER OUTPUT

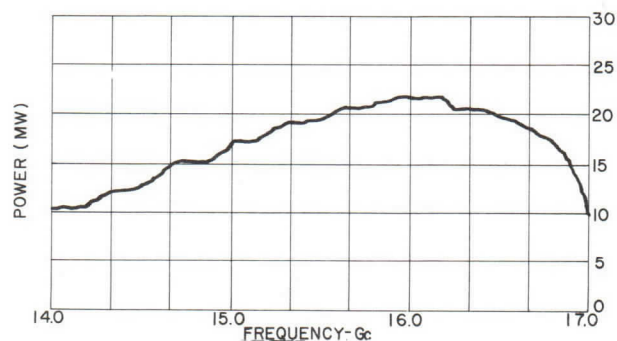

BACKWARD-WAVE OSCILLATORS
(SOLENOID FOCUSED)

SHORT-FORM LISTING

SOLENOID-FOCUSED TUBES

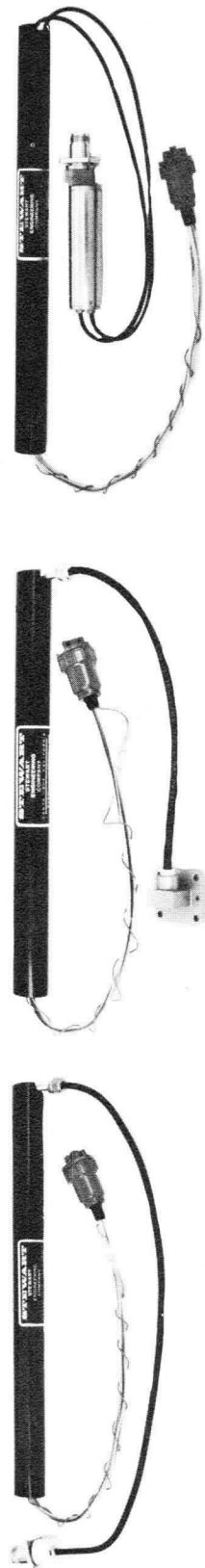

TECHNICAL DATA—STANDARD SOLENOID-FOCUSED† TUBES

POWER OUTPUT DATA	OD 1-2	OD 1-2.6	OD 2-4	OD 3.7	OD 4-8	OD 5.2	OD 5.4	OD 6	OD 6-12	OD 7-13	OD 10-15	OD 12	OD 15-22	OD 18-27
Power Output, mW	50	50	30	30	10	10	10	30	10	10	10	10	5	5
Peak-to-Peak variation, db	8	6	6	6	10	6	3	6	8	3	6	6	10	6
Bandwidth over which measured, Gc	1.0-2.0	1-2.6	2.0-4.0	3.7-5.9	4-8	5.2-8.3	5.4-5.9	7.0-11.0	6.0-12.0	8.2-12.4	10-15.5	12.4-18	15-22	18-27
ELECTRICAL CHARACTERISTICS														
Cathode Current, mA Maximum	12	12	8	6	7	6	7	7	7	7	10	7	10	6
Helix Voltage, kV Maximum	21-1.02	.18-1.3	.33-1.8	54-2.1	.25-2.1	.47-2.2	.5-7	0.5-2.2	0.24-2.1	0.5-2.0	.35-1.8	0.5-1.9	0.2-2.0	0.5-1.9
Helix Current, mA Maximum	1.5	1.5	3.0	3.0	3.0	3.0	3.0	3.0	3.0	3.0	3.0	3.0	3.0	3.0
Anode Voltage, V Maximum	140	150	125	128	150	120	150	140	125	130	180	200	200	200
Anode Current, mA Maximum	.8	.5	.6	.5	.3	.5	.3	.3	.5	.3	1.0	1.0	1.0	1.0
Grid Cutoff Voltage, V Maximum	-7	-10	-8	-10	-7	-10	-7	-10	-10	-10	-10	-15	-15	-10
Solenoid Magnetic Field, Gauss Minimum	650	800	800	800	800	800	800	800	800	800	900	900	1150	1200
Uniform to 97% over length of Total Spurious Content, db below signal, Min.	63"	63"	64"	63"	63"	63"	63"	63"	5 1/2"	5 1/2"	3 3/4"	3 3/4"	3 1/2"	3"
MECHANICAL DATA														
Capsule Length, Inches	12 13/16	12 13/16	12 13/16	12 13/16	12 13/16	12 13/16	12 13/16	12 13/16	12 13/16	12 13/16	11 1/2	11 1/2	11 1/2	8 1/2
Net Weight, Ounces	19	19	18	16	16	16	16	15	15	15	15	15	15	7
Output Connector††	2	2	2	1	1	1	1	1	1	3 or 1	5	4	6	7

*Second Harmonic Content: -20db or better; all other
extraneous signal components 40db or more below main signal ††1-Type "N" Connector, RG55U coax 2—Balun into Type "N" Connector 3—RG52U guide on RG55U coax cable
4—RG91/U guide on RG55U coax cable 5—WR75 guide on RG55U coax cable 6—WR51 guide cover flange 7—UG595/U flange

†Solenoid magnets are available from Stewart, although most OEM's make or procure them to suit their particular packaging requirements.

APPLICABLE TO ALL TUBES:

- Capsule Diameter—1 inch
- Power Cable Connector—Winchester P6MP
- Heater Voltage—6.3V ±5%
- Heater Current—0.9A
- Cooling Air Pressure—0.1" H₂O at end of capsule

**Solenoid tubes with extra power, extra bandwidth,
lower power variation, and other features are
normally available on special order.**

BACKWARD-WAVE OSCILLATOR

The Type OD 1-2 BWO is a bifilar (dual helix), voltage tunable oscillator. Solenoid-focused, this wide band oscillator is well suited for use as a swept signal source in signal generators, particularly in view of its high stability. Other applications include ECM receivers (as local oscillator), frequency diversity transmitters (as master oscillator), and other electronic equipment. The OD 1-2 features smooth power over the band, low cathode current, and two control electrodes. The control grid makes possible power cutoff with low negative grid voltage. Power output can be modulated with either the grid or anode, or both. Cathode modulation with the grid grounded usually reduces FM caused by AM. With all voltages isolated from both tube housing and the r.f. output terminal, packaging problems are simplified, since the tube housing and output connector can be grounded regardless of power supply configuration.

**FOR REPLACEMENT
PURPOSES ONLY**

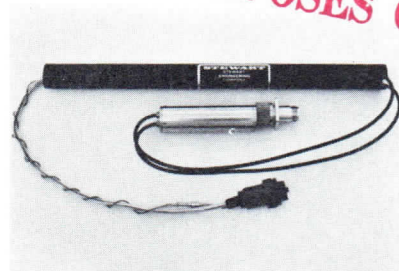

ELECTRICAL CHARACTERISTICS, CW

	Typical Values	Absolute Ratings
Nominal Frequency Band, Gc	1-2	*
Power Output into Load VSWR=1.25, mW	90-250	50 Min. 8 Max.
Power Output Variation, db		3 Max.
Fine Grain Variation, db/250 mc		
Tube VSWR	2.5:1	
Spurious Oscillation		
Ratio of Signal to 2nd Harmonic Output, db	38	20 Min.
Ratio of Signal to all other Spurious Output, db	60	40 Min.
Sensitivity to Heater Voltage, Mc/V	4	8 Max.
Sensitivity to Magnetic Field, Mc/ Δ 10%	1	4 Max.
Sensitivity to Anode Voltage, Mc/V	0.1	0.5 Max.
Sensitivity to Grid Voltage, Mc/V	1.5	5 Max.
Tuning Curve Slope, Mc/V		
Low End (1.0 Gc)	4.4	
Mid-Frequency (1.5 Gc)	2.3	
High End (2.0 Gc)	1.1	
Grid r.f. Cutoff Voltage, V	-7	-20 Max.
Collector Voltage above Helix (Note 1), V	50-150	150 Max.
Solenoid Magnetic Field, Gauss	650	600 Min.
Uniform within 3% Total Variation over Length of		6-3/4"
Capacitance; Cathode to all other Electrodes incl. heater, uuf	15	25 Max.
Capacitance; Grid to all other Electrodes at Power Input Plug, uuf	20	25 Max.
Capacitance; Helix to all other Electrodes and Capsule (18-1/2" Coax Cable Attached), uuf	300	350 Max.

11/63

* Selected tubes with extra power, extra bandwidth, lower power variation and other features are normally available on special order. These are design data only. For operating instructions refer to Stewart Instruction Sheet furnished with tube.

ELECTRICAL CHARACTERISTICS, CW (Contd.)

	Typical Values	Absolute Ratings
Heater Voltage, V		$6.3 \pm 5\%$
Heater Current, A	0.85	1.2 Max.
Heater-to-Cathode Leakage ($E_{hk} = \pm 90V$), μA		25 Max.
Cathode Current, mA	12	25 Max.
Helix Voltage Range, V	210-1020	150-1200 Min./Max.
Helix Current, mA	1.5	4.0 Max.
Anode Voltage, V	140	250 Max.
Anode Current, mA	0.8	2 Max.
Anode Supply Impedance, Ohms		50K Max.

MECHANICAL DATA

Capsule Length, In.	12-13/16	
Capsule Diameter, In.	1	
Weight, Oz.		19 Max.
Power Cable Length (Winchester P6MP Connector), In.	13-1/2	
Output Cable Length (Type N Connector on Balun), In.	18-1/2	
Cooling Air Pressure at End of Capsule, Inches H ₂ O		0.1 Min.
Gladd-to-Metal Seal Temperature, °C		200 Max.

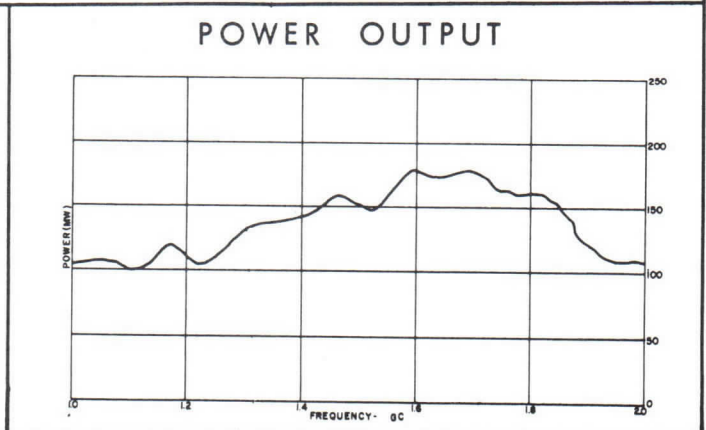
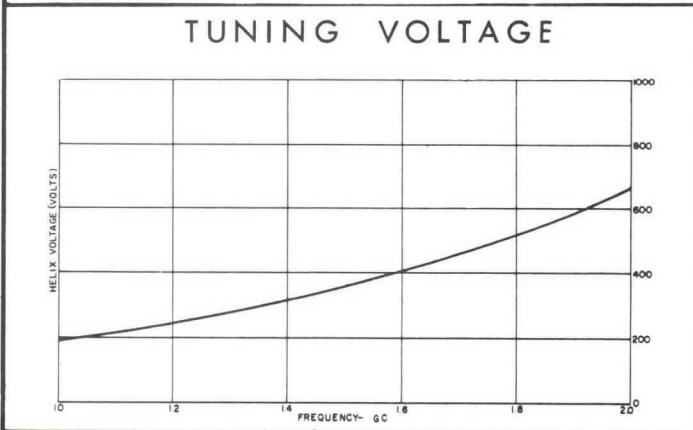
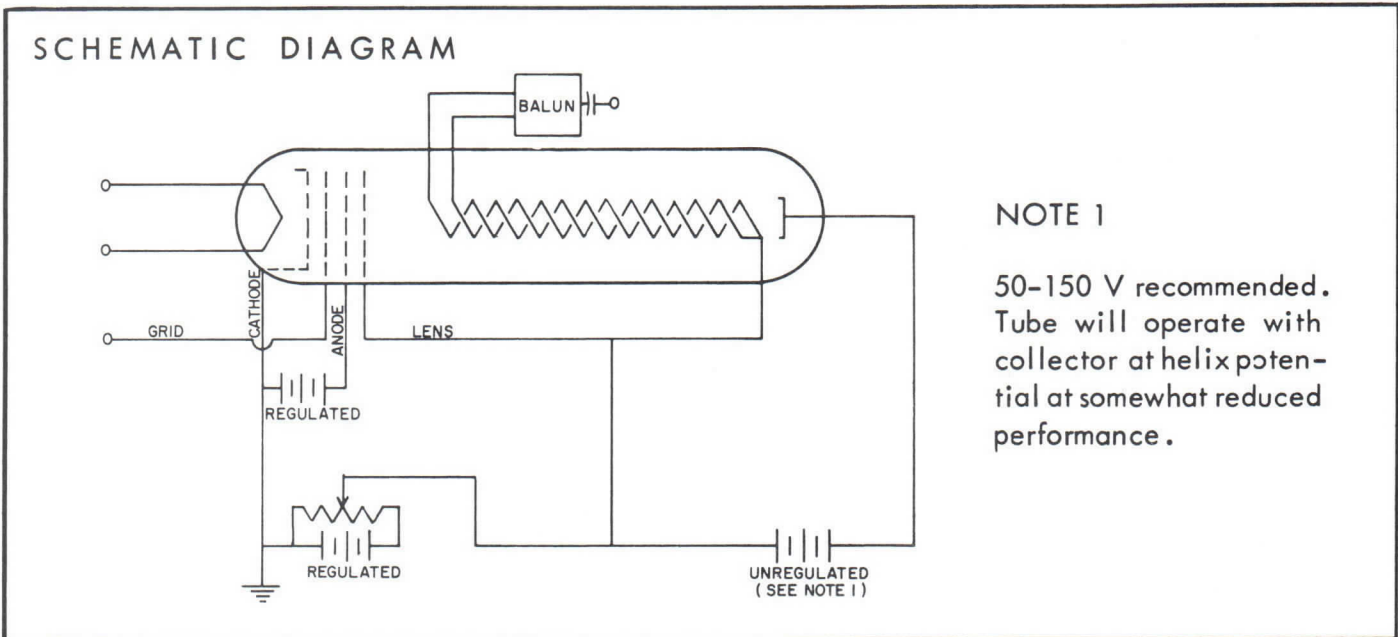

BACKWARD-WAVE OSCILLATOR

The Type OD 1-2.6 BWO is a bifilar (dual helix), voltage tunable oscillator. Solenoid focused, this wide band oscillator is well suited for use as a swept signal source in signal generators, particularly in view of its high stability. Other applications include ECM receivers (as local oscillator), frequency diversity transmitters (as master oscillator), and other electronic equipment. The OD 1-2.6 features smooth power over the band, low cathode current, and two control electrodes. The control grid makes possible power cutoff with low negative grid voltage. Power output can be modulated with either the grid or anode, or both. Cathode modulation with the grid grounded usually reduces FM caused by AM. With all voltages isolated from both tube housing and the r.f. output terminal, packaging problems are simplified, since the tube housing and output connector can be grounded regardless of power supply configuration.

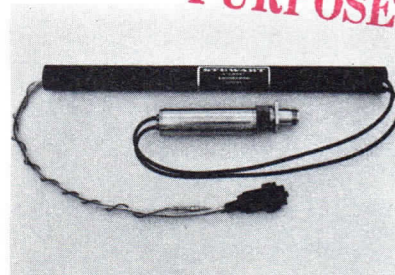

**FOR REPLACEMENT
PURPOSES ONLY**

ELECTRICAL CHARACTERISTICS, CW

	Typical Values	Absolute Ratings
Nominal Frequency Band, Gc	1.0-2.6	*
Power Output into Load VSWR=1.25, mW	90-350	50 Min.
Power Output Variation, db		10 Max.
Fine Grain Variation, db/250 mc		3 Max.
Spurious Oscillation		
Ratio of Signal to 2nd Harmonic Output, db	40	20 Min.
Ratio of Signal to all other Spurious Output, db	60	40 Min.
Sensitivity to Heater Voltage, Mc/V	5	10 Max.
Sensitivity to Magnetic Field, Mc/Δ 10%	1.5	3.0 Max.
Sensitivity to Anode Voltage, Kc/V	200	500 Max.
Sensitivity to Grid Voltage, Mc/V	5	10 Max.
Tuning Curve Slope, Mc/V		
Low End (1.0 Gc)	3.8	
Mid-Frequency (1.8 Gc)	1.4	
High End (2.6 Gc)	0.56	
Grid r.f. Cutoff Voltage, V	-7	-20 Max.
Collector Voltage above Helix (Note 1), V	50-150	150 Max.
Solenoid Magnetic Field, Gauss	650	600 Min.
Uniform Within 3% Total Variation Over Length of		6-3/4" Min.
Capacitance; Cathode to all other Electrodes Incl. Heater, uuf	15	25 Max.
Capacitance; Grid to all other Electrodes at Power Input Connector, uuf	20	25 Max.
Capacitance; Helix to all other Electrodes and Capsule (18-1/2" Coax Cable Attached), uuf	300	350 Max.

10/63

* Selected tubes with extra power, extra bandwidth, lower power variation and other features are normally available on special order. These are design data only. For operating instructions refer to Stewart Instruction Sheet furnished with tube.

ELECTRICAL CHARACTERISTICS, CW (Contd.)

	Typical Values	Absolute Ratings
Heater Voltage, V		6.3 ± 5%
Heater Current, A	0.85	1.2 Max.
Heater-to-Cathode Leakage ($E_{hk} = +90V$), μA		25 Max.
Cathode Current, mA		18 Max.
Helix Voltage Range, V	190-1450	150-1700 Min/Max.
Helix Current, mA	1.5	3.0 Max.
Anode Voltage, V	75-150	250 Max.
Anode Current, mA	1.0	2.0 Max.
Anode Supply Impedance, Ohms		50K Max.

MECHANICAL CHARACTERISTICS

Capsule Length, In.	12-13/16	
Capsule Diameter, In.	1	
Weight, Oz.		19 Max.
Power Cable Length (Winchester P6MP Connector), In.	13-1/2	
Output Cable Length (Type N Connector on Balun, In.)	18-1/2	
Cooling Air Pressure at End of Capsule, Inches H ₂ O		0.1 Min.
Glass-to-Metal Seal Temperature, °C		200 Max.

SCHEMATIC DIAGRAM

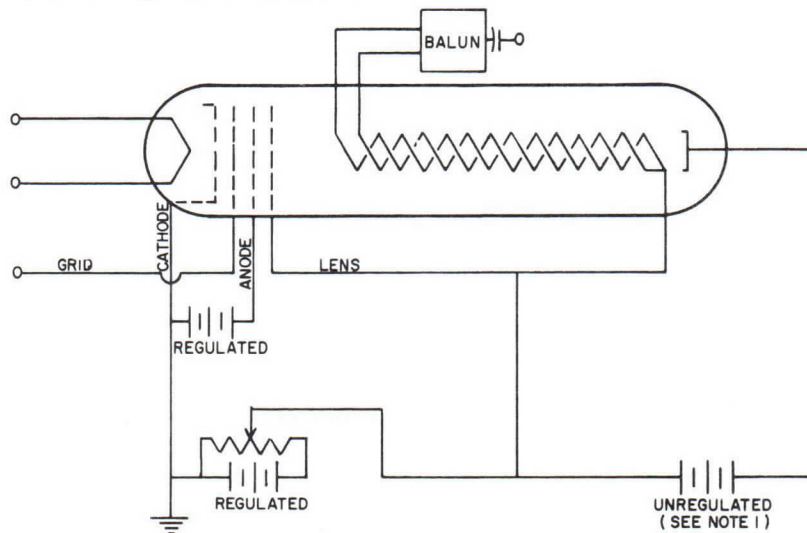

NOTE 1

50-150 V recommended. Tube will operate with collector at helix potential at somewhat reduced performance.

TUNING VOLTAGE

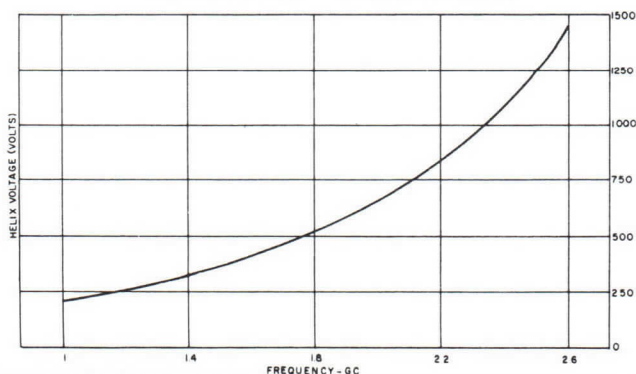

POWER OUTPUT

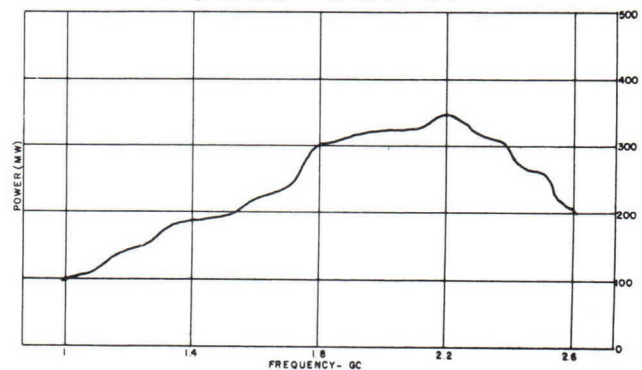

BACKWARD-WAVE OSCILLATOR

The Type OD 2-4 BWO is a bifilar (dual helix), voltage tunable oscillator. Solenoid-focused, this wide band oscillator is well suited for use as a swept signal source in signal generators, particularly in view of its high stability. Other applications include ECM receivers (as local oscillator), frequency diversity transmitters (as master oscillator), and other electronic equipment. The OD 2-4 features smooth power over the band, low cathode current, and two control electrodes. The control grid makes possible power cutoff with low negative grid voltage. Power output can be modulated with either the grid or anode, or both. Cathode modulation with the grid grounded usually reduces FM caused by AM. With all voltages isolated from both tube housing and the r.f. output terminal, packaging problems are simplified, since the tube housing and output connector can be grounded regardless of power supply configuration.

**FOR REPLACEMENT
PURPOSES ONLY**

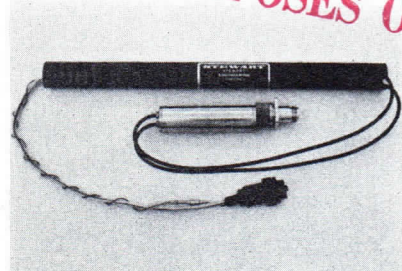

ELECTRICAL CHARACTERISTICS, CW

	Typical Values	Absolute Ratings
Nominal Frequency Band, Gc	2-4	*
Power Output into a Load with VSWR=1.25, mW	90-160	30 Min. 6 Max.
Power Output Variation, db		3 Max.
Fine Grain Variation, db/250mc		2.5:1 Max.
Tube VSWR		
Spurious Oscillator		
Ratio of Signal to 2nd Harmonic Output, db	40	20 Min.
Ratio of Signal to all other Spurious Output, db	50	40 Min.
Sensitivity to Heater Voltage, Mc/V	2	8 Max.
Sensitivity to Magnetic Field, Mc/ Δ 10%	0.1	0.3 Max.
Sensitivity to Anode Voltage	25	100 Max.
Sensitivity to Grid Voltage, Mc/V	3	6 Max.
Tuning Curve Slope, Mc/V		
Low End (2.0 Gc)	6.7	
Mid-Frequency (3.0 Gc)	3.0	
High End (4.0 Gc)	1.0	
Grid r.f. Cutoff Voltage, V	-8	-20 Max.
Collector Voltage Above Helix (Note 1), V	50-150	150 Max.
Solenoid Magnetic Field, Gauss	800	750 Min.
Uniform Within 3% Total Variation Over Length of		6-3/4" Min.
Capacitance; Cathode to all other Electrodes incl. Heater, uuf	18	25 Max.
Capacitance; Grid to all other Electrodes at Power Input Plug, uuf	18	25 Max.
Capacitance; Helix to all other Electrodes and Capsule (18-1/2" Coax Cable Attached), uuf	250	300 Max.

10/63

* Selected tubes with extra power, extra bandwidth, lower power variation and other features are normally available on special order. These are design data only. For operating instructions refer to Stewart Instruction Sheet furnished with tube.

ELECTRICAL CHARACTERISTICS, CW (Contd.)

	Typical Values	Absolute Ratings
Heater Voltage, V		$6.3 \pm 5\%$
Heater Current, A	0.85	1.2 Max.
Heater-to-Cathode Leakage ($E_{hk} = \pm 90V$), μA		25 Max.
Cathode Current, mA	8	12 Max.
Helix Voltage Range, V	330-1800	300-1900 Min/Max.
Helix Current, mA	1	3 Max.
Anode Voltage, V	130	250 Max.
Anode Current, mA	0.6	1.5 Max.
Anode Supply Impedance, Ohms		50K Max.

MECHANICAL DATA

Capsule Length, In.	12-13/16	
Capsule Diameter, In.	1	
Weight, Oz.		18 Max.
Power Cable Length (Winchester P6MP Connector), In.	13-1/2	
Output Cable Length (Type N Connector on Balun), In.	18-1/2	
Cooling Air Pressure at End of Capsule, In. H ₂ O		0.1 Min.
Glass-to-Metal Seal Temperature, °C		200 Max.

SCHEMATIC DIAGRAM

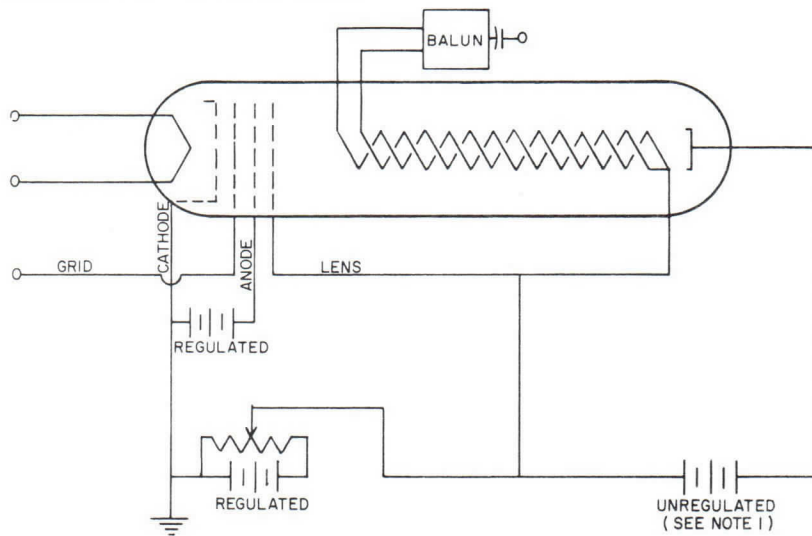

NOTE 1

50-150 V recommended. Tube will operate with collector at helix potential at somewhat reduced performance.

TUNING VOLTAGE

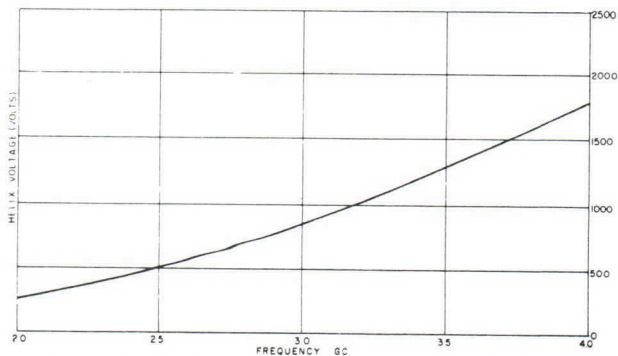

POWER OUTPUT

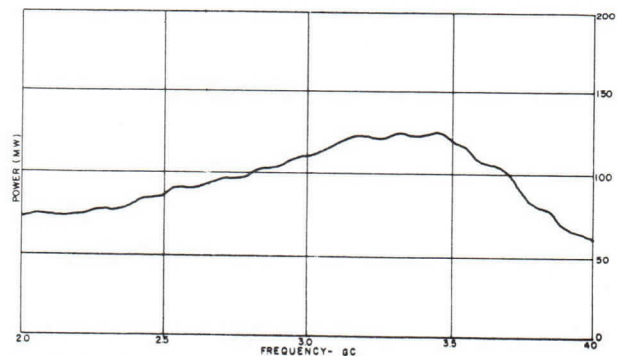

BACKWARD-WAVE OSCILLATOR

The Type OD 4-8 BWO is a single-helix, voltage tunable oscillator. Solenoid-focused, this wide band oscillator is well suited for use as a swept signal source in signal generators, particularly in view of its high stability. Other applications include ECM receivers (as local oscillator), frequency diversity transmitters (as master oscillator), and other electronic equipment. The OD 4-8 features smooth power over the band, low cathode current, and two control electrodes. The control grid makes possible power cutoff with low negative grid voltage. Power output can be modulated with either the grid or anode, or both. Cathode modulation with the grid grounded usually reduces FM caused by AM. With all voltages isolated from both tube housing and the r.f. output terminal, packaging problems are simplified, since the tube housing and output connector can be grounded regardless of power supply configuration.

**FOR REPLACEMENT
PURPOSES ONLY**

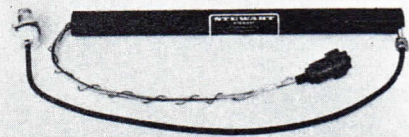

ELECTRICAL CHARACTERISTICS, CW

	Typical Values	Absolute Ratings
Nominal Frequency Band, Gc	4-8	*
Power Output into a Load with VSWR=1.25, mW	10-60	10 Min.
Power Output Variation, db		10 Max.
Fine Grain Variation, db/250 mc		3 Max.
Tube VSWR		2.5:1 Max.
Ratio of Signal to Total Spurious Output, db	50	40 Min.
Sensitivity to Heater Voltage, Mc/V	5	10 Max.
Sensitivity to Magnetic Field, Mc/ Δ 10%	0.5	1 Max.
Sensitivity to Anode Voltage, Mc/V	0.5	1 Max.
Sensitivity to Grid Voltage, Mc/V	4	7 Max.
Tuning Curve Slope, Mc/V		
Low End (4.0 Gc)	8.0	
Mid-Frequency (6.0 Gc)	2.7	
High End (8.0 Gc)	0.95	
Grid r.f. Cutoff Voltage, V	-7	-20 Max.
Collector Voltage Above Helix (Note 1), V	50-150	150 Max.
Solenoid Magnetic Field, Gauss	800	750 Min.
Uniform Within 3% Total Variation Over Length of		6-3/8 Min.
Capacitance; Cathode to all other Electrodes incl. heater, uuf	18	25 Max.
Capacitance; Grid to all other Electrodes, at Power Input Connector, uuf	15	25 Max.
Capacitance; Helix to all other Electrodes and Capsule (18-1/2" Coax Cable Attached), uuf	170	200 Max.

10/63

* Selected tubes with extra power, extra bandwidth, lower power variation and other features are normally available on special order. These are design data only. For operating instructions refer to Stewart Instruction Sheet furnished with tube.

ELECTRICAL CHARACTERISTICS, CW (Contd.)

	Typical Values	Absolute Ratings
Heater Voltage, V		6.3 ± 5%
Heater Current, A	0.85	1.2 Max.
Heater-to-Cathode Leakage ($E_{hk} = \pm 90V$), μA		25 Max.
Cathode Current, mA	7.0	10.0 Max.
Helix Voltage Range, V	250-2100	200-2200 Min/Max.
Helix Current, mA	1.0	3.0 Max.
Anode Voltage, V	150	250 Max.
Anode Current, mA	0.3	2.0 Max.
Anode Supply Impedance, Ohms		50K Max.

MECHANICAL DATA

Capsule Length, In.	12-13/16	
Capsule Diameter, In.	1	
Weight, Oz.		16 Max.
Power Cable Length (Winchester P6MP Connector), In.	13-1/2	
Output Cable Length (Type N Connector), In.	18-1/2	
Cooling Air Pressure at End of Capsule, In. H ₂ O		0.1 Min.
Glass-to-Metal Seal Temperature, °C		200 Max.

SCHEMATIC DIAGRAM

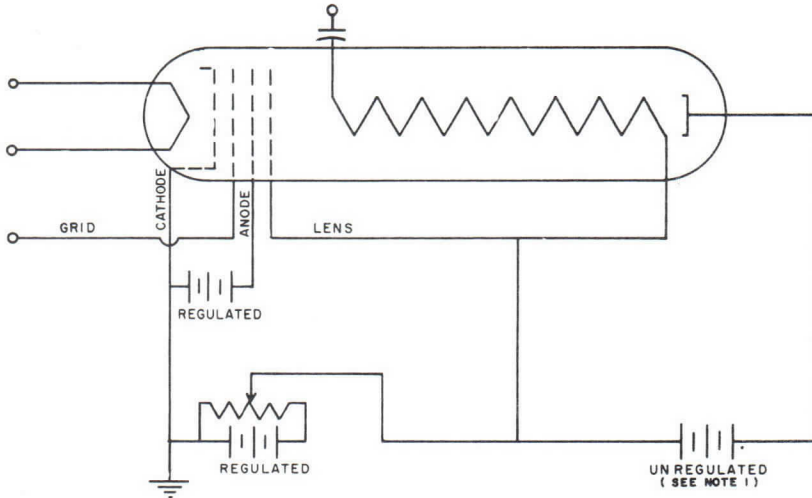

NOTE 1

50-150 V recommended. Tube will operate with collector at helix potential at somewhat reduced performance.

TUNING VOLTAGE

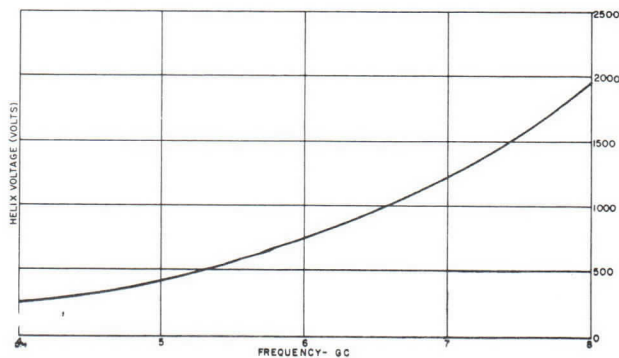

POWER OUTPUT

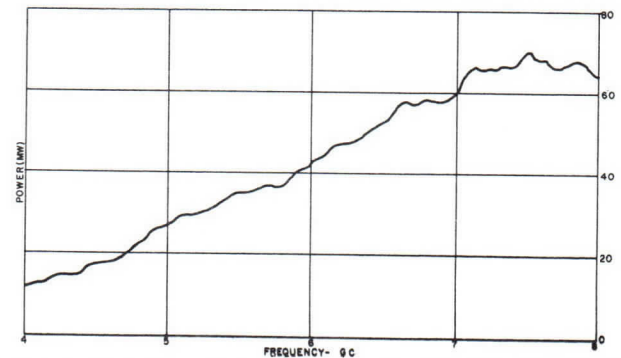

BACKWARD-WAVE OSCILLATOR

The Type OD 5.4-6.0 BWO is a single-helix, voltage tunable oscillator. Solenoid-focused, this wide band oscillator is well suited for use as a swept signal source in signal generators, particularly in view of its high stability. Other applications include ECM receivers (as local oscillator), frequency diversity transmitters (as master oscillator), and other electronic equipment. The OD 5.4-6.0 features smooth power over the band, low cathode current, and two control electrodes. The control grid makes possible power cutoff with low negative grid voltage. Power output can be modulated with either the grid or anode, or both. Cathode modulation with the grid grounded usually reduces FM caused by AM. With all voltages isolated from both tube housing and the r.f. output terminal, packaging problems are simplified, since the tube housing and output connector can be grounded regardless of power supply configuration.

FOR REPLACEMENT PURPOSES ONLY

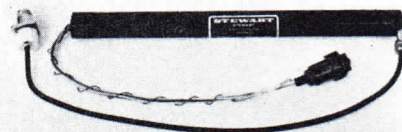

ELECTRICAL CHARACTERISTICS

	Typical Values	Absolute Ratings
Nominal Frequency Band	5.4-6.0	*
Power Output into a Load with VSWR=1.25, mW	55-70	50 Min.
Power Output Variation, db		3 Max.
Fine Grain Variation, db/100mc		1.5 Max.
Tube VSWR		2:1 Max.
Ratio of Signal to Total Spurious Output, db	55	40 Min.
Sensitivity to Heater Voltage, Mc/V	5	10 Max.
Sensitivity to Magnetic Field, Mc/Δ10%	0.5	1 Max.
Sensitivity to Anode Voltage, Mc/V	0.5	1 Max.
Sensitivity to Grid Voltage, Mc/V	4	7 Max.
Tuning Curve Slope, Mc/V		
Low End (5.4 Gc)	3.6	
Mid-Frequency (5.7 Gc)	3.2	
High End (6.0 Gc)	2.7	
Grid r.f. Cutoff Voltage, V	-7	-20 Max.
Collector Voltage above Helix (Note 1), V	50-150	150 Max.
Solenoid Magnetic Field, Gauss	800	750 Min.
Uniform within 3% Total Variation Over Length of		6-3/8" Min.
Capacitance; Cathode to all other Electrodes inc. heater, uuf	18	25 Max.
Capacitance; Grid to all other Electrodes, at Power Input Connector, uuf	15	25 Max.
Capacitance; Helix to all other Electrodes and Capsule (18-1/2" Coax Cable Attached), uuf	170	200 Max.

* Selected tubes with extra power, extra bandwidth, lower power variation and other features are normally available on special order. These are design data only. For operating instructions refer to Stewart Instruction Sheet furnished with tube.

ELECTRICAL CHARACTERISTICS, CW (Contd.)

	Typical Values	Absolute Ratings
Heater Voltage, V		6.3 ± 5%
Heater Current, A	0.85	1.2 Max.
Heater-to-Cathode Leakage ($E_{hk} = \pm 90V$), μA		0.1 Max.
Cathode Current, mA	7	10 Max.
Helix Voltage Range, V	550-750	450-900 Min/Max.
Helix Current, mA	1	3 Max.
Anode Voltage, V	150	250 Max.
Anode Current, mA	0.3	2 Max.
Anode Supply Impedance, Ohms		50K Max.

MECHANICAL DATA

Capsule Length, In.	12-13/16	
Weight, Oz.		16 Max.
Power Cable Length (Winchester P6MP connector), In.	13-1/2	
Output Cable Length (Type N Connector), In.	18-1/2	
Cooling Air Pressure at End of Capsule, In. H ₂ O		0.1 Min.
Glass-to-Metal Seal Temperature, °C		200 Max.

SCHEMATIC DIAGRAM

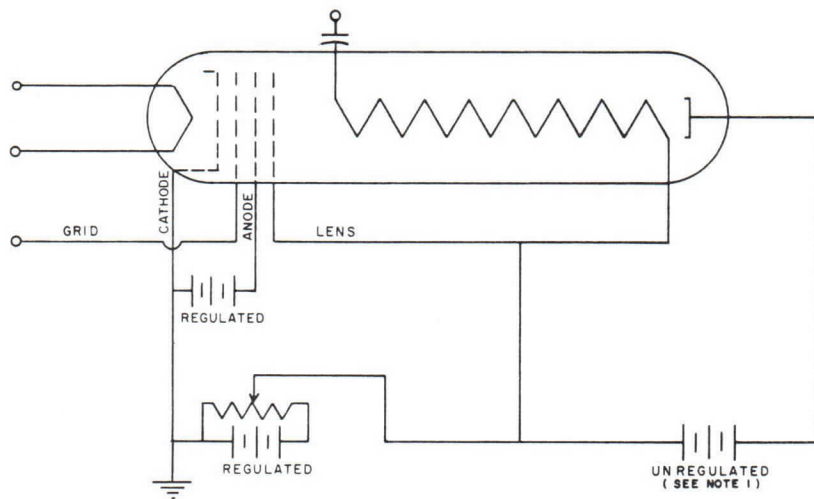

NOTE 1

50-150 V recommended. Tube will operate with collector at helix potential at somewhat reduced performance.

TUNING VOLTAGE

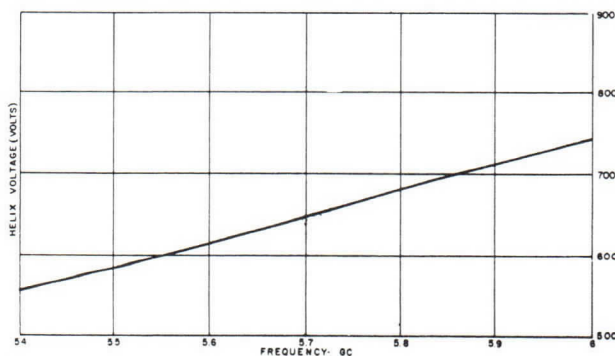

POWER OUTPUT

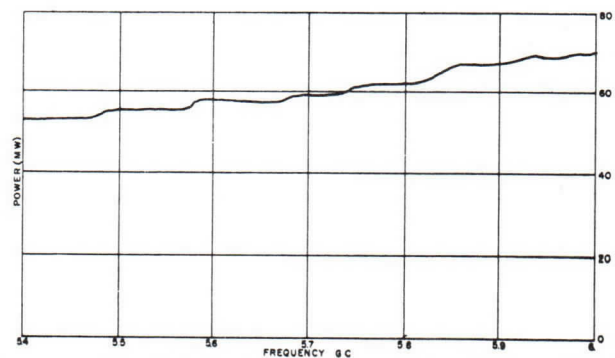

FOR REPLACEMENT PURPOSES ONLY

BACKWARD-WAVE OSCILLATOR

The Type OD 7-13 BWO is a single-helix, voltage tunable oscillator. Solenoid-focused, this wide band oscillator is well suited for use as a swept signal source in signal generators, particularly in view of its high stability. Other applications include ECM receivers (as local oscillator), frequency diversity transmitters (as master oscillator), and other electronic equipment. The OD 7-13 features smooth power over the band, low cathode current, and two control electrodes. The control grid makes possible power cutoff with low negative grid voltage. Power output can be modulated with either the grid or anode, or both. Cathode modulation with the grid grounded usually reduces FM caused by AM. With all voltages isolated from both tube housing and the r.f. output terminal, packaging problems are simplified, since the tube housing and output connector can be grounded regardless of power supply configuration. Output cable with either Type N or waveguide adapter termination can be specified.

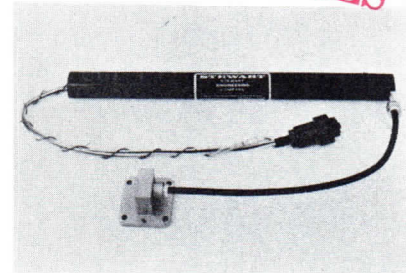

ELECTRICAL CHARACTERISTICS, CW

	Typical Values	Absolute Ratings
Nominal Frequency Band, Gc	8.2-12.4	*
Power Output into Load VSWR = 1.25, mW	13-22	10 Min.
Power Output Variation, db		3 Max.
Fine Grain Variation, db/250 mc		3 Max.
Tube VSWR		2:1 Max.
Ratio of Signal to Total Spurious Output, db	52	40 Min.
Sensitivity to Heater Voltage, Mc/V	5	10 Max.
Sensitivity to Magnetic Field, Mc/Δ10%	2	4 Max.
Sensitivity to Anode Voltage, Mc/V	0.5	1 Max.
Sensitivity to Grid Voltage, Mc/V	7	12 Max.
Tuning Curve Slope, Mc/V		
Low End (8.2 Gc)	5	
Mid-Frequency (10.3 Gc)	3.2	
High End (12.4 Gc)	1.6	
Grid r.f. Cutoff Voltage, V	-10	-20 Max.
Collector Voltage Above Helix (Note 1), V	50-150	150 Max.
Solenoid Magnetic Field, Gauss	800	750
Uniform Within 3% Total Variation Over Length of		5-1/2" Min.
Capacitance; Cathode to all other Electrodes incl. heater, uuf	35	45 Max.
Capacitance; Grid to all other Electrodes at Power Input Plug, uuf	14	18 Max.
Capacitance; Helix to all other Electrodes and Capsule (18-1/2" Coax Cable Attached), uuf	175	200 Max.

* Selected tubes with extra power, extra bandwidth, lower power variation and other features are normally available on special order. These are design data only. For operating instructions refer to Stewart Instruction Sheet furnished with tube.

ELECTRICAL CHARACTERISTICS, CW (Contd.)

	Typical Values	Absolute Ratings
Heater Voltage, V		6.3 ± 5%
Heater Current, A	0.75	1.2 Max.
Heater-to-Cathode Leakage ($E_{hk} = -90V$), μA		25 Max.
Cathode Current, mA	4.5	7.0 Max.
Helix Voltage Range, V	500-1950	450-2000 Min/Max.
Helix Current, mA	2	3 Max.
Anode Voltage, V	130	250 Max.
Anode Current, mA	0.4	2.0 Max.
Anode Supply Impedance, Ohms		50K Max.

MECHANICAL DATA

Capsule Length, In.	11-1/2	
Weight, Oz.		15 Max.
Capsule Diameter, In.	1	
Power Cable Length (Winchester P6MP Connector), In.	13-1/2	
Output Cable Length (Type N or UG39/U Flange), In.	18-1/2	
Cooling Air Pressure at End of Capsule, In. H ₂ O		0.1 Min.
Glass-to-Metal Seal Temperature, °C		200 Max.

SCHEMATIC DIAGRAM

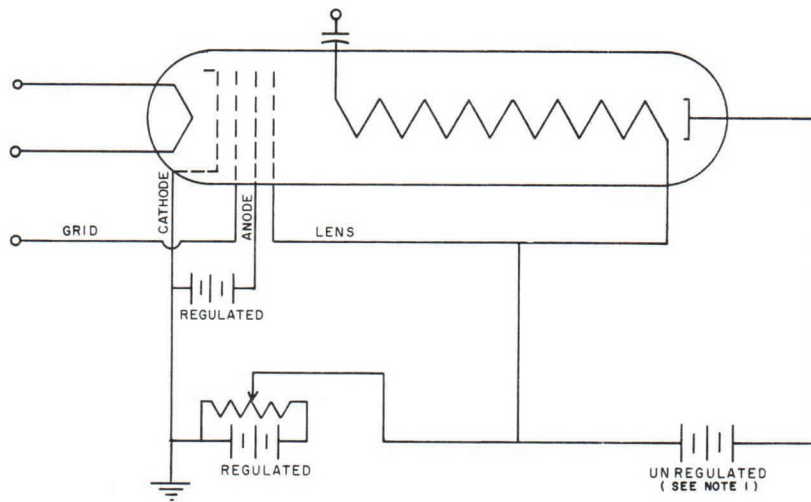

NOTE 1

50-150 V recommended. Tube will operate with collector at helix potential at somewhat reduced performance.

TUNING VOLTAGE

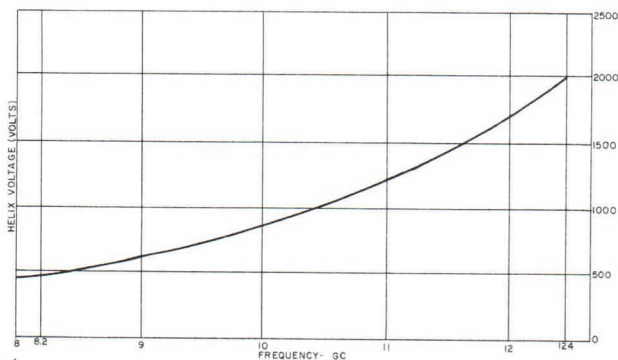

POWER OUTPUT

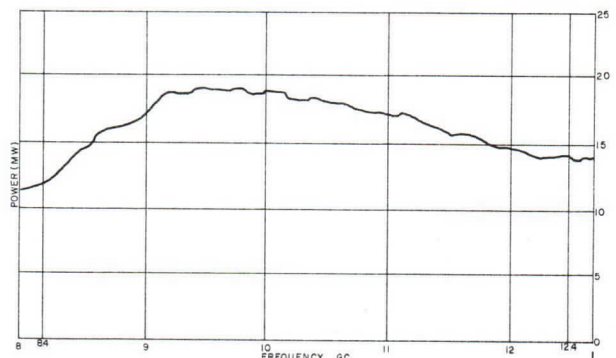

BACKWARD-WAVE OSCILLATOR

The Type OD 12-18B BWO is a single-helix, voltage tunable oscillator. Solenoid-focused, this wide band oscillator is well suited for use as a swept signal source in signal generators, particularly in view of its high stability. Other applications include ECM receivers (as local oscillator), frequency diversity transmitters (as master oscillator), and other electronic equipment. The OD 12-18B features smooth power over the band, low cathode current, and two control electrodes. The control grid makes possible power cutoff with low negative grid voltage. Power output can be modulated with either the grid or anode, or both. Cathode modulation with the grid grounded usually reduces FM caused by AM. With all voltages isolated from both tube housing and the r.f. output terminal, packaging problems are simplified, since the tube housing and output connector can be grounded regardless of power supply configuration.

FOR REPLACEMENT PURPOSES ONLY

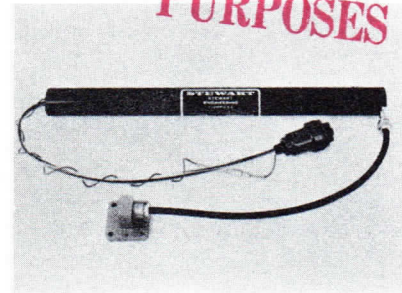

ELECTRICAL CHARACTERISTICS, CW

	Typical Values	Absolute Ratings
Nominal Frequency Band, Gc	12.4-18	*
Power Output into Load VSWR=1.25, mW	12-30	10 Min.
Power Output Variation, db		6 Max.
Fine Grain Variation, db/250 mc		3 Max.
Tube VSWR		3:1 Max.
Ratio of Signal to Total Spurious Output, db	48	40 Min.
Sensitivity to Heater Voltage, Mc/V	5	10 Max.
Sensitivity to Magnetic Field, Mc/Δ10%	0.5	1.5 Max.
Sensitivity to Anode Voltage, Mc/V	0.5	1.5 Max.
Sensitivity to Grid Voltage, Mc/V	3	6 Max.
Tuning Curve Slope, Mc/V		
Low End (12.4 Gc)	8.7	
Mid-Frequency (15.2 Gc)	4.4	
High End (18.0 Gc)	2.2	
Grid r.f. Cutoff Voltage, V	-15	-25 Max.
Collector Voltage Above Helix (Note 1), V	50-150	150 Max.
Solenoid Magnetic Field, Gauss	900	800 Min.
Uniform Within 3% Total Variation Over Length of		3-3/4" Min.
Capacitance; Cathode to all other Electrodes incl. Heater, uuf	12	15 Max.
Capacitance; Grid to all other Electrodes, at Power Input Connector, uuf	15	20 Max.
Capacitance; Helix to all other Electrodes and Capsule (9" Coax Cable Attached), uuf	100	125 Max.

* Selected tubes with extra power, extra bandwidth, lower power variation and other features are normally available on special order. These are design data only. For operating instructions refer to Stewart Instruction Sheet furnished with tube.

ELECTRICAL CHARACTERISTICS, CW (Contd.)

	Typical Values	Absolute Ratings
Heater Voltage, V		6.3 ± 5%
Heater Current, A	0.87	1.2 Max.
Heater-to-Cathode Leakage ($E_{hk} = -90V$), μA		25 Max.
Cathode Current, mA	7	12 Max.
Helix Voltage Range, V	530-1900	500-2000 Min/Max.
Helix Current, mA	2	3 Max.
Anode Voltage, V	200	250 Max.
Anode Current, mA	1.0	2 Max.
Anode Supply Impedance, Ohms		50K Max.

MECHANICAL DATA

Capsule Length, In.	11-1/2	
Capsule Diameter, In.	1	
Weight, Oz.		15 Max.
Power Cable Length (Winchester P6MP Connector), In.	13-1/2	
Output Cable Length (UG419/U Flange), In.	9	
Cooling Air Pressure at End of Capsule, In. H ₂ O		0.1 Min.
Glass-to-Metal Seal Temperature, °C		200 Max.

SCHEMATIC DIAGRAM

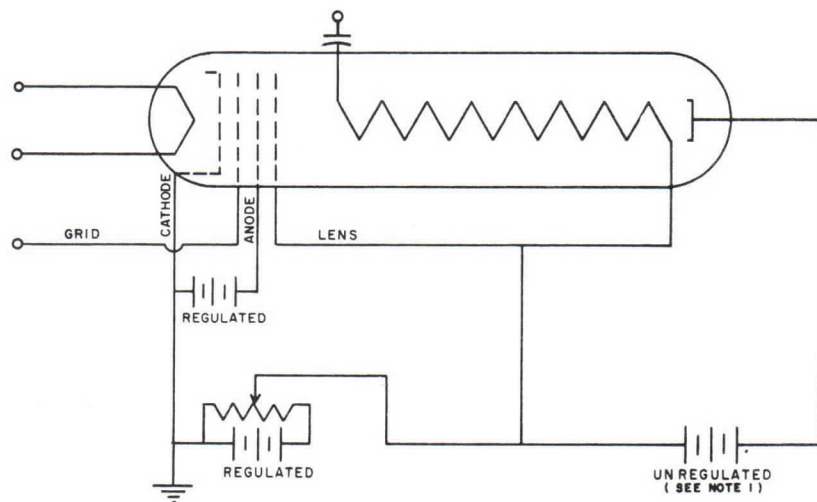

NOTE 1

50-150 V recommended. Tube will operate with collector at helix potential at somewhat reduced performance.

TUNING VOLTAGE

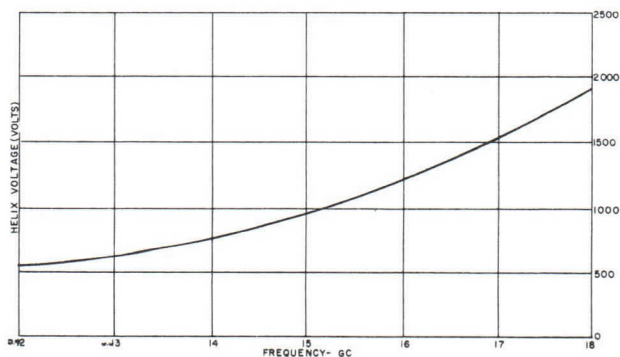

POWER OUTPUT

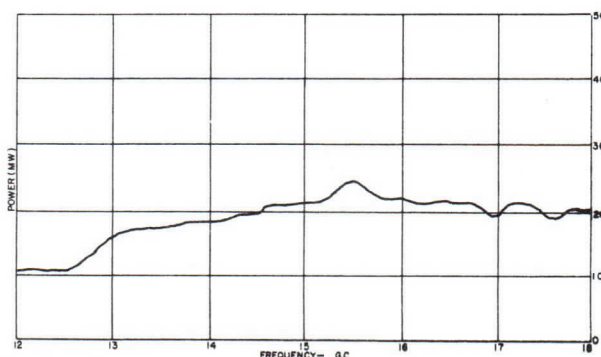

BACKWARD-WAVE OSCILLATOR

The Type OD18-27 BWO is a single-helix, voltage tunable oscillator. Solenoid-focused, this wide band oscillator is well suited for use as a swept signal source in signal generators, particularly in view of its high stability. Other applications include ECM receivers (as local oscillator), frequency diversity transmitters (as master oscillator), and other electronic equipment. The OD 18-27 features smooth power over the band, low cathode current, and two control electrodes. The control grid makes possible power cutoff with low negative grid voltage. Power output can be modulated with either the grid or anode, or both. Cathode modulation with the grid grounded usually reduces FM caused by AM. With all voltages isolated from both tube housing and the r.f. output terminal, packaging problems are simplified, since the tube housing and output connector can be grounded regardless of power supply configuration.

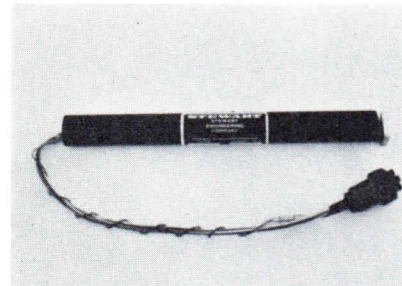

ELECTRICAL CHARACTERISTICS, CW

	Typical Values	Absolute Ratings
Nominal Frequency Band, Gc	18-27	*
Power Output into Load VSWR=1.25, mW	8-20	5 Min.
Power Output Variation, db		6 Max.
Fine Grain Variation, db/250mc		3 Max.
Tube VSWR		3:1 Max.
Ratio of Signal to Total Spurious Output, db	50	40 Min.
Sensitivity to Heater Voltage, Mc/V	5	10 Max.
Sensitivity to Magnetic Field, Mc/ Δ 10%	0.5	1.5 Max.
Sensitivity to Anode Voltage, Mc/V	0.5	1.5 Max.
Sensitivity to Grid Voltage, Mc/V	3	6 Max.
Tuning Curve Slops, Mc/V		
Low End (18 Gc)	12.3	
Mid-Frequency (22.5 Gc)	7.0	
High End (27 Gc)	3.5	
Grid r.f. Cutoff Voltage, V	-10	-25 Max.
Collector Voltage Above Helix (Note 1), V	75-150	300 Max.
Solenoid Magnetic Field, Gauss	1200	1100 Min.
Uniform Within 3% Total Variation Over Length of		3" Min.
Capacitance; Cathode to all other Electrodes Incl. Heater uuf	30	40 Max.
Capacitance; Grid to all other Electrodes, at Power Input		
Connector, uuf	20	25 Max.
Capacitance; Helix to all other Electrodes and Capsule	60	75 Max.

11/63

* Selected tubes with extra power, extra bandwidth, lower power variation and other features are normally available on special order. These are design data only. For operating instructions refer to Stewart Instruction Sheet furnished with tube.

ELECTRICAL CHARACTERISTICS, CW (Contd.)

	Typical Values	Absolute Ratings
Heater Voltage, V		6.3 ± 5%
Heater Current, A	0.9	0.6-1.2 Min/Max.
Heater-to-Cathode Leakage ($E_{hk} = -90V$), μA		25 Max.
Cathode Current, mA	6	12 Max.
Helix Voltage Range, V	510-1950	475-2000 Min/Max.
Helix Current, mA	2	3 Max.
Anode Voltage, V	200	250 Max.
Anode Current, mA	1	2 Max.
Anode Supply Impedance, Ohms		50K Max.

MECHANICAL DATA

Overall Length, In.	9	
Capsule Diameter, In.	1	
Weight, Oz.		7 Max.
Power Cable Length (Winchester P6MP Connector), In.	13-1/2	
Output Flange	UG595/U	
Cooling Air Pressure at End of Capsule, In. H ₂ O		0.1 Min.
Glass-to-Metal Seal Temperature, °C		200 Max.

SCHEMATIC DIAGRAM

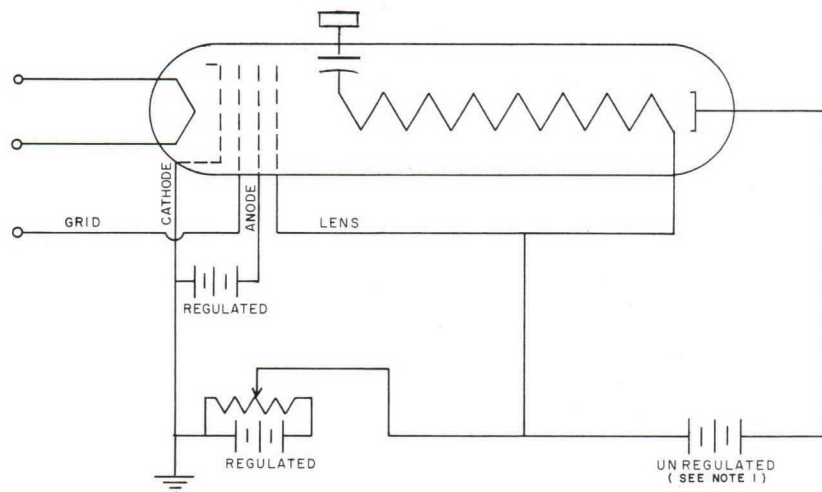

NOTE 1

50-150 V recommended. Tube will operate with collector at helix potential at somewhat reduced performance.

TUNING VOLTAGE

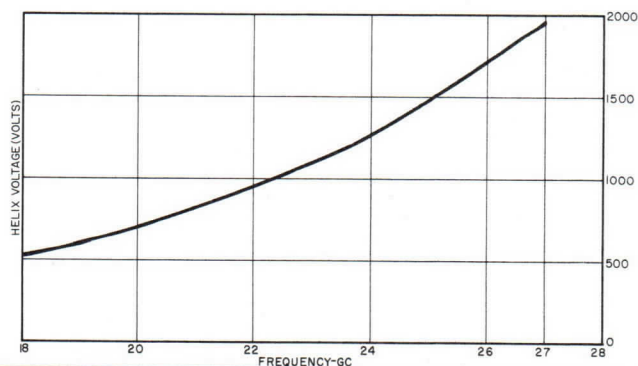

POWER OUTPUT

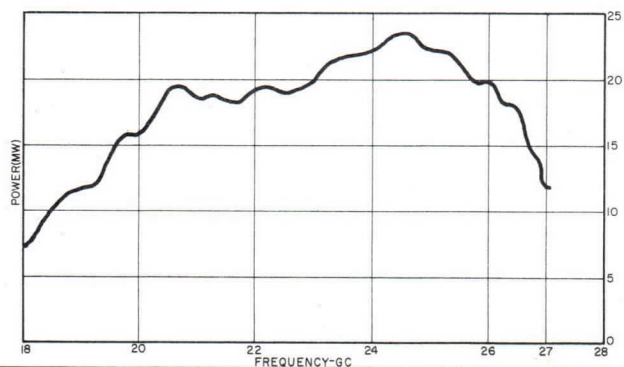

Effective August 1, 1963

PRICE SCHEDULE

Standard Backward-Wave Oscillators

Type	Price	Other Types Also Available	
		Type	Price
OD 1-2	\$ 1,000.00	OD 1-2.6	\$ 1,250.00
OD 2-4	1,000.00	OD 1.5-2.5	1,000.00
OD 3.7-5.9	800.00	OD 2.3-4.45	1,100.00
OD 4-8	900.00	OD 3-5	900.00
OD 5.2-8.3	800.00	OD 7-13B*	850.00
OD 6-11B (30 mW Min)	900.00	OD 15-22	1,500.00
OD 6-12	900.00	OD 18-27	1,900.00
OD 7-13	900.00		
OD 10-15	1,000.00		
OD 12-18	1,100.00		

Permanent-Magnet Focused Backward-Wave Oscillators

Type	Price	Type	Price
SE 201	\$ 1,200.00	SE 206	\$ 1,100.00
SE 201A	1,130.00	SE 206A	950.00
SE 203	1,200.00	SE 207	1,300.00
SE 204	1,300.00	SE 209	1,200.00
SE 204A	1,165.00	SE 209A	1,130.00
SE 205	1,100.00	SE 211A	1,200.00
SE 205A	950.00	SE 301	1,900.00
		SE 302	1,800.00

*Similar to OD 7-13 but with 6 db maximum power variation

- NOTES:** 1. Quantity discounts quoted on application for specific needs.
2. Terms are net 30 days, F.O.B. Santa Cruz, California. All prices are subject to change without notice.